

CATALOGO

Ledme-europa

M

LEDME

INDICE

INDEX

MANIFIESTO 3

SMARTHOME 8

ILUMINACIÓN INTERIOR 22

AROS GU10 / MR16 Y ACCESORIOS 76

ILUMINACIÓN INDUSTRIAL 80

ILUMINACIÓN EXTERIOR 90

ILUMINACIÓN SOLAR 116

PISCINAS 132

ALUMBRADO PÚBLICO 140

ILUMINACIÓN COMERCIAL 152

TIRAS, NEÓN LED Y PERFIL 184

DETECTORES DE PRESENCIA 232

MATERIAL ELÉCTRICO 236

MANIFIESTO



Ledme

Fundada en 2016, Ledme-Europa se ha consolidado como un referente en el mercado de iluminación LED a nivel europeo. Nuestra empresa se enorgullece de ofrecer productos de alta calidad, servicios excepcionales y un compromiso continuo con la innovación y la excelencia en todos los aspectos de nuestro negocio.

En Ledme-Europa, nos enorgullece nuestro compromiso con la excelencia y la satisfacción del cliente. Trabajamos incansablemente para superar las expectativas y ofrecer soluciones de iluminación LED que transformen espacios y mejoren vidas en toda Europa.

Founded in 2016, Ledme-Europe has established itself as a leader in the European LED lighting market. Our company prides itself on offering high-quality products, exceptional services, and a continuous commitment to innovation and excellence in all aspects of our business.

At Ledme-Europe, we take pride in our commitment to excellence and customer satisfaction. We work tirelessly to exceed expectations and provide LED lighting solutions that transform spaces and enhance lives across Europe.

Nuestro equipo

Our team

En Ledme-Europa, contamos con un equipo altamente capacitado y dedicado que impulsa nuestro éxito. Desde nuestros ingenieros hasta nuestro personal de ventas y atención al cliente, cada miembro de nuestro equipo está comprometido con la satisfacción del cliente y la excelencia en su trabajo. Valoramos la diversidad, la creatividad y el trabajo en equipo, lo que nos permite alcanzar nuestros objetivos con éxito.

At Ledme-Europe, we boast a highly skilled and dedicated team that drives our success. From our engineers to our sales and customer service staff, every member of our team is committed to customer satisfaction and excellence in their work. We value diversity, creativity, and teamwork, enabling us to successfully achieve our goals.



Nuestras instalaciones

Our facilities

Nuestras instalaciones, que abarcan más de 40,000 metros cuadrados de espacio de almacenamiento, nos permiten mantener un amplio inventario de productos y garantizar una rápida respuesta a las necesidades de nuestros clientes en toda Europa. Con tecnología de vanguardia y sistemas de gestión eficientes, nuestras instalaciones están diseñadas para optimizar la logística y el cumplimiento de pedidos.

Our facilities, spanning over 40,000 square meters of storage space, enable us to maintain a vast inventory of products and ensure a quick response to our customers' needs across Europe. With cutting-edge technology and efficient management systems, our facilities are designed to optimize logistics and order fulfillment.

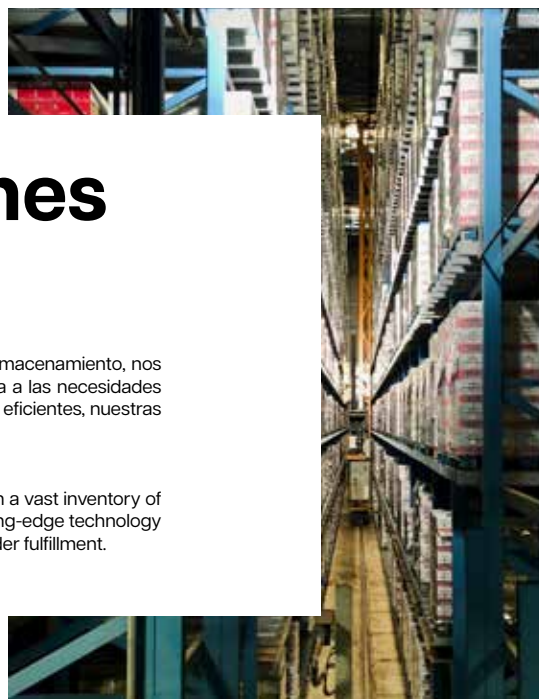

“La buena organización del trabajo es el puente que conecta los sueños con la realidad, transformando metas en logros y caos en éxito”

“The good organization of work is the bridge that connects dreams with reality, turning goals into achievements and chaos into success.”

NUESTROS SERVICIOS

OUR SERVICES

Qué ofrecemos? What we offer?

En Ledme-Europa, ofrecemos una gama completa de servicios para satisfacer las necesidades de nuestros clientes. Desde la fabricación de nuestros productos hasta la investigación y desarrollo de nuevas tecnologías, pasando por estrategias de marketing innovadoras y estudios de diseño de iluminación con Dialux, nos comprometemos a brindar soluciones integrales y personalizadas que impulsen el éxito de nuestros clientes.

At Ledme-Europe, we provide a comprehensive range of services to meet our customers' needs. From manufacturing our products to researching and developing new technologies, as well as implementing innovative marketing strategies and conducting lighting design studies with Dialux, we are committed to delivering holistic and customized solutions that drive our customers' success.

La calidad es nuestra máxima prioridad. Nos comprometemos a cumplir con los más altos estándares de calidad en todos nuestros productos y procesos. Desde la selección de materiales hasta la fabricación y pruebas finales, implementamos rigurosos controles de calidad para garantizar la fiabilidad y el rendimiento óptimo de nuestros productos.

Quality is our top priority. We are committed to meeting the highest standards of quality in all our products and processes. From material selection to manufacturing and final testing, we implement rigorous quality controls to ensure the reliability and optimal performance of our products.



Investigación y Desarrollo (I+D) Research and Development (R&D)

La innovación es fundamental en Ledme-Europa. Nuestro equipo de I+D trabaja constantemente en el desarrollo de nuevas tecnologías y mejoras de producto para ofrecer soluciones de iluminación LED avanzadas y eficientes. Nos esforzamos por estar a la vanguardia de la industria, anticipando las tendencias del mercado y respondiendo a las necesidades cambiantes de nuestros clientes.

Innovation is key at Ledme-Europe. Our R&D team continuously works on developing new technologies and product enhancements to provide advanced and efficient LED lighting solutions. We strive to stay at the forefront of the industry, anticipating market trends and responding to the evolving needs of our customers.

Estudios de Dialux: Dialux Studies:

En Ledme-Europa, comprendemos la importancia de proporcionar soluciones de iluminación precisas y eficientes. Nuestros expertos en diseño de iluminación utilizan el software Dialux para realizar estudios detallados y ofrecer recomendaciones personalizadas que maximicen el rendimiento y la eficiencia de nuestros productos en una variedad de aplicaciones.



Marketing

Nuestro departamento de marketing está dedicado a promover la marca Ledme-Europa y nuestros productos en todo el continente. A través de estrategias de marketing innovadoras y campañas creativas, nos aseguramos de que nuestra marca sea reconocida como sinónimo de calidad, fiabilidad y excelencia en iluminación LED.

Our marketing department is dedicated to promoting the Ledme-Europe brand and our products across the continent. Through innovative marketing strategies and creative campaigns, we ensure that our brand is recognized as synonymous with quality, reliability, and excellence in LED lighting.



Distribución internacional International distribution

Gracias a nuestra sólida red de distribución, nuestros productos llegan a clientes de toda Europa de manera rápida y eficiente. Trabajamos con socios de distribución confiables y comprometidos que comparten nuestra visión y valores, asegurando que nuestros productos estén disponibles en los mercados clave de la región.

Thanks to our robust distribution network, our products reach customers across Europe quickly and efficiently. We collaborate with reliable and committed distribution partners who share our vision and values, ensuring that our products are available in key markets throughout the region



10. Bulb LED Smarthome G45 6W



10. Bulb LED Smarthome C37 6W



10. Bulb LED Smarthome E27 A60 10W



10. Bulb LED Smarthome Gu10 5W



12. SmartHome Dial App Tuya CCT LED Ceiling Light



12. SmartHome Nail 9W RGB+CCT LED Downlight



12. SmartHome Rainbow 24W IP54 WiFi App Tuya CCT LED Ceiling Light



13. SmartHome LED Panel 60x60 cm RGB+CCT



15. SmartHome RGB+CCT LED Floodlight



16. 2.4 GHz Gateway



17. SmartHome Led Monocolor/cct Dimmer Controller



18. Mini Controller for RGBW LED Strips with IR Remote Control / Tuya Magic Home App



18. Mini SmartHome RGB LED Strip Controller with IR Remote / Tuya App Control



18. Dimmable Power Supply controlled by Tuya App, LED 200W 24VDC RGB+CCT



19. WiFi SmartHome Plug 16A



20. WiFi SmartHome Plug 16A

SmartHome



Bulb LED SmartHome G45 RGB+CCT



IP: IP20
POWER SUPPLY: 220-240V ac
ANGLE: 240°
BRIGHTNESS: 600
MATERIAL: Aluminio / PC
LIGHT SOURCE: Led
DURABILITY: 20000
RECEPTOR: wifi 2.4 GHz
CRI: 80

REF	W	SIZE	COLOR	*K
LM7145	6	45X78H mm	Opal	RGB+CCT



Bulb LED SmartHome C37 RGB+CCT



IP: IP20
POWER SUPPLY: 220-240V ac
ANGLE: 240°
BRIGHTNESS: 600
MATERIAL: Aluminio / PC
POWER SUPPLY: Led
DURABILITY: 20000
RECEPTOR: wifi 2.4 GHz
CRI: 80

REF	W	SIZE	COLOR	*K
LM7144	6	37X108H mm	Opal	RGB+CCT



Bulb LED SmartHome E27 A60 RGB+CCT



IP: IP20
POWER SUPPLY: 220-240V ac
ANGLE: 240°
BRIGHTNESS: 1000
MATERIAL: Aluminio / PC
LIGHT SOURCE: Led
DURABILITY: 20000
RECEPTOR: wifi 2.4 GHz
CRI: 80

REF	W	SIZE	COLOR	*K
LM7141	10	60X123H mm	Opal	RGB+CCT



Bulb LED SmartHome GU10 RGB+CCT



IP: IP20
POWER SUPPLY: 220-240V ac
ANGLE: 120°
BRIGHTNESS: 500
MATERIAL: Aluminio / PC
LIGHT SOURCE: Led
DURABILITY: 20000
RECEPTOR: wifi 2.4 GHz
CRI: 80

REF	W	SIZE	COLOR	*K
LM7140	5	50X55H mm	Opal	RGB+CCT



Lighting with millions of combinations

El modo de color RGB (Rojo, Verde, Azul) es un modelo de color orientado al hardware.

El sistema adopta el modelo de color RGB para la visualización de imágenes. El modelo de color RGB pertenece al principio de mezcla de color es aditivos. Cuanto mayor sea el valor de cada color primario, más brillante será el color.

Cuando RGB es 0, es negro y cuando RGB es 255, es blanco. Una lámpara RGB tiene colores de luz ajustables. Se superponen de varias maneras para reproducir una amplia gama de colores.

Es uno de los modelos de color más utilizados. Un sistema RGB puede tener 16.777.216 (256³) Colores posibles. El sistema RGB también se denomina RGB24 (modo de 24 bits).

Como modelo orientado al hardware el sistema se adapta a la adición de colores. Cuanto mayor sea el valor de cada color primario, más brillante será el color. Cuando RGB es 0, es negro y cuando RGB es 255, es blanco.

La iluminación explicada en RGB nos dice que la luz está compuesta por ondas de energía, que cuando se combinan se llaman espectro. Las diferentes luces que vemos están compuestas de diversos Colores. Al final de cada espectro, **hay una longitud de onda corta**, y ese es el color azul. En el otro extremo del espectro hay **una longitud de onda más**, que es el color rojo. Las otras luces que vemos en el espectro están entre el rojo y el azul.

The RGB (Red, Green, Blue) color mode is a hardware-oriented color model.

The system adopts the RGB color model for image display. The RGB color model belongs to the principle of additive color mixing. The higher the value of each primary color, the brighter the color.

When RGB is 0, it is black, and when RGB is 255, it is white. An RGB lamp has adjustable light colors. They are overlaid in various ways to reproduce a wide range of colors. It is one of the most commonly used color models. An RGB system can have 16,777,216 (256³) possible colors. The RGB system is also called RGB24 (24-bit mode).

As a hardware-oriented model, the system adapts to color addition. The higher the value of each primary color, the brighter the color. When RGB is 0, it is black, and when RGB is 255, it is white.

Explained in RGB lighting terms, it tells us that light is composed of energy waves, which when combined are called a spectrum. The different lights we see are composed of various colors.

At the end of each spectrum, there is a short wavelength, which is the color blue. At the other end of the spectrum, there is a longer wavelength, which is the color red. The other lights we see in the spectrum are between red and blue.

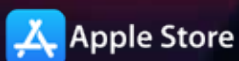

SmartHome Dial App Tuya CCT LED Ceiling Light



IP:
IP20
POWER SUPPLY:
170-265V ac
ANGLE:
180°
BRIGHTNESS:
3000
MATERIAL:
Aluminio / PC
LIGHT SOURCE:
Epistar
DURABILITY:
30000
RECEPTOR:
Bluetooth
CRI:
80
DIMMABLE:
Si



REF	W	SIZE	COLOR	°K
LM8233	24	390X65mm	Blanco /White	CCT



Smarthome Nail 9W RGB+CCT LED Downlight



IP:
IP20
POWER SUPPLY:
220-240V ac
ANGLE:
120°
BRIGHTNESS:
3000
MATERIAL:
Aluminio / PC
LIGHT SOURCE:
Smd Led
DURABILITY:
30000
RECEPTOR:
wifi 2.4 GHz
CRI:
80
DIMMABLE:
Si



REF	W	SIZE	CUT	COLOR	°K
LM4280	9	113X58 mm	90 mm	Blanco /White	CCT+RGB



Compatible accessories:



LM2128
Kit de Conversion de Emergencia Hasta 20W

SmartHome Rainbow 24W IP54 WiFi App Tuya CCT LED Ceiling Light



IP:
IP54
POWER SUPPLY:
220-240V ac
ANGLE:
120°
BRIGHTNESS:
2400
MATERIAL:
Aluminio / PC
LIGHT SOURCE:
Smd Led
DURABILITY:
30000
RECEPTOR:
wifi 2.4 GHz
CRI:
80
DIMMABLE:
Si



REF	W	SIZE	COLOR	°K
LM8230	24	280X48H mm	Blanco /White	CCT+RGB



SmartHome LED Panel 60x60 cm RGB+CCT



*ledme
europa*

IP:
IP40
POWER SUPPLY:
110-240V ac
ANGLE:
120°
BRIGHTNESS:
3300
MATERIAL:
Aluminio
LIGHT SOURCE:
Smd 2835 / 5050
DURABILITY:
40000 Hr
UGR:
19
CRI:
80
WORKING TIME:
-10°C + 50°C

REF	W	SIZE	COLOR	°K
LM5304	40	595X595X10H mm	Blanco	CCT+RGB



Included Remote control

Compatible accessories:



LM9031
Colgadores Para Paneles Led 3M

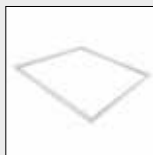

LM9035
Marco de Empotrar de Panel 60X60 Blanco



LM9033
Grapas Para Paneles Led



LM9032
Kit de Superficie de Panel 60X60 Blanco 65 Mm



Synchronized needs



La solución de sincronización se basa en el desarrollo del módulo de modo dual Wi-Fi y Bluetooth LE de alto rendimiento de Tuya.

Es compatible con enlaces de control dual para el control remoto de Wi-Fi y el control local de Bluetooth, y puede realizar una conmutación perfecta automática e inteligente, lo que puede ocurrir en entornos de red de Wi-Fi deficientes.

En el caso de fluctuaciones, aún se puede garantizar un control fluido del usuario, lo que puede mejorar en gran medida la experiencia del usuario. Además, la solución admite puntos de función enriquecidos, como el control remoto por infrarrojos, la atenuación segmentada, el modo de no molestar, el biorritmo, etc.

También proporciona una variedad de paneles de control para que los clientes elijan, lo que es adecuado para la inteligentización de varios tipos de productos de iluminación.

Los asistentes de voz "Hey Alexa - Show Us Around" pueden llevar sus apartamentos inteligentes al siguiente nivel, proporcionando una experiencia verdaderamente sin contacto para los residentes. Vincule dispositivos inteligentes y escenas con sus parlantes para que tanto los residentes actuales como los futuros puedan disfrutar de la experiencia del hogar inteligente desde el primer momento.

The synchronization solution is based on the development of Tuya's high-performance dual-mode Wi-Fi and Bluetooth LE module.

It supports dual control links for remote Wi-Fi control and local Bluetooth control, and can perform seamless automatic and intelligent switching, which can occur in deficient Wi-Fi network environments.

In the case of fluctuations, smooth user control can still be guaranteed, greatly enhancing the user experience. Additionally, the solution supports rich function points, such as infrared remote control, segmented dimming, do-not-disturb mode, biorhythm, etc.

It also provides a variety of control panels for customers to choose from, suitable for the smartification of various types of lighting products.

Voice assistants like "Hey Alexa - Show Us Around" can take your smart apartments to the next level, providing a truly hands-free experience for residents. Link smart devices and scenes with your speakers so that both current and future residents can enjoy the smart home experience from the get-go.



Smarthome RGB+CCT LED Floodlight



IP: IP65
POWER SUPPLY: 220-240V ac
ANGLE: 120°
BRIGHTNESS: 75 LMW
MATERIAL: Aluminio / PC
LIGHT SOURCE: Smd Led
DURABILITY: 30000
RECEPTOR: wifi 2.4 GHz
CRI: 80
WORKING TIME: -20°C + 45°C



REF	W	SIZE	COLOR	*K
LM6519	50	164,2X31,7X194,9H mm	Negro / Black	CCT+RGB
LM6520	100	198,6X33X194,9H mm	Negro / Black	CCT+RGB



App

Nos centramos en la innovación de todos nuestros productos, mientras brindamos a los usuarios experiencias únicas e interactivas para impulsar la competitividad en el mercado.

Nuestras aplicaciones admiten varios idiomas, incluidos chino, inglés, alemán, francés y japonés.

La localización de idiomas continuamente actualizada y mejorada lo ayudará a ingresar sin problemas a un mercado extranjero.

Automatización completa del hogar, compartiendo el acceso al hogar inteligente con miembros de la familia y estableciendo permisos de acceso específicos para miembros; Obtenga información sobre el clima local y la calidad del aire en tiempo real.

El centro de control central para que sus residentes administren y personalicen sus hogares inteligentes: una aplicación descargable diseñada y creada por nosotros, pero hecha para su disfrute.

Tuya Smart es una plataforma global de desarrollo de IoT que crea estándares de interconectividad para satisfacer las necesidades inteligentes de marcas, OEM, desarrolladores y cadenas minoristas en una amplia gama de industrias y dispositivos inteligentes.

Basado en la nube pública global, Tuya conecta diferentes escenarios inteligentes y dispositivos inteligentes proporcionando herramientas de desarrollo de hardware, integrando servicios de nube global y ofreciendo una plataforma de desarrollo empresarial inteligente.

Tuya proporciona un empoderamiento inteligente integral desde la tecnología hasta el marketing para fomentar un ecosistema de desarrolladores neutral, abierto y accesible.

We focus on innovating all our products, providing users with unique and interactive experiences to drive competitiveness in the market.

Our applications support multiple languages, including Chinese, English, German, French, and Japanese.

Continuously updated and enhanced language localization will help you seamlessly enter foreign markets.

Complete home automation, sharing smart home access with family members, and setting specific access permissions for members; Get real-time local weather and air quality information.

The central control hub for your residents to manage and customize their smart homes: a downloadable app designed and created by us, but made for their enjoyment.

Tuya Smart is a global IoT development platform that creates interconnectivity standards to meet the smart needs of brands, OEMs, developers, and retailers across a wide range of industries and smart devices.

Based on the global public cloud, Tuya connects different smart scenarios and smart devices by providing hardware development tools, integrating global cloud services, and offering an intelligent business development platform.

Tuya provides comprehensive smart empowerment from technology to marketing to foster a neutral, open, and accessible developer ecosystem.

2.4 GHz Gateway



IP:
IP20
POWER SUPPLY:
5V
MATERIAL:
PC
RECEPTOR:
wifi 2.4 GHz
DETECTION DIST:
30 m

REF	SIZE	COLOR
LM2089	63X63X15H mm	Blanco / White



Included
App Tuya

Compatible accessories:



LM2081
Controlador Regulador
Led Rgb/rgbw/rgb+Cct



LM2080
Controlador Regulador
Led Monocolor/cct



LM2084
Controlador Regulador
Monocolor+Cct 12/24V
Dc + Mando Rf



LM2085
Controlador Regulador
Rgb+Cct 12/24V Dc +
Mando Rf



LM2086
Controlador Regulador
Rgb+Cct 12/24V Dc +
Mando Rf

El Puerto de Enlace 2.4 Ghz es una herramienta tecnológica que ha revolucionado el mundo de la conectividad inalámbrica. Con su capacidad para transmitir datos a través de la frecuencia de 2.4 GHz, este dispositivo se ha convertido en una solución eficiente y confiable para diversas aplicaciones.

Una de las principales ventajas del **Puerto de Enlace 2.4 Ghz** es su capacidad para controlar y regular dispositivos electrónicos, como el **Controlador Regulador Smarthome LED**. Este controlador permite ajustar la intensidad de la iluminación LED de forma precisa y sencilla.

Distancia de detección de **30 metros**, lo que garantiza una cobertura amplia y confiable en cualquier entorno. Esta característica es especialmente útil en aplicaciones industriales, donde se requiere una comunicación estable y sin interferencias.

Esta frecuencia es compatible con la mayoría de los dispositivos electrónicos y ofrece una velocidad de transmisión de datos óptima.

The 2.4 GHz Gateway is a technological tool that has revolutionized the world of wireless connectivity. With its ability to transmit data through the 2.4 GHz frequency, this device has become an efficient and reliable solution for various applications.

One of the main advantages of the 2.4 GHz Gateway is its ability to control and regulate electronic devices, such as the LED Smart Home Dimmer Controller. This controller allows for precise and simple adjustment of LED lighting intensity.

With a detection range of 30 meters, it ensures wide and reliable coverage in any environment. This feature is especially useful in industrial applications, where stable and interference-free communication is required.

This frequency is compatible with most electronic devices and offers optimal data transmission speed.



16 million colorful possibilities

SPECIFICATIONS

IP

IP20

POWER SUPPLY

12-24V DC

MATERIAL

PC

MAX POWER

144(12V) - 288 (24V) DC

WORKING TEMP

-10°C +40°C

RECEPTOR

wifi 2.4 GHz

DETECTION DIST

30 m

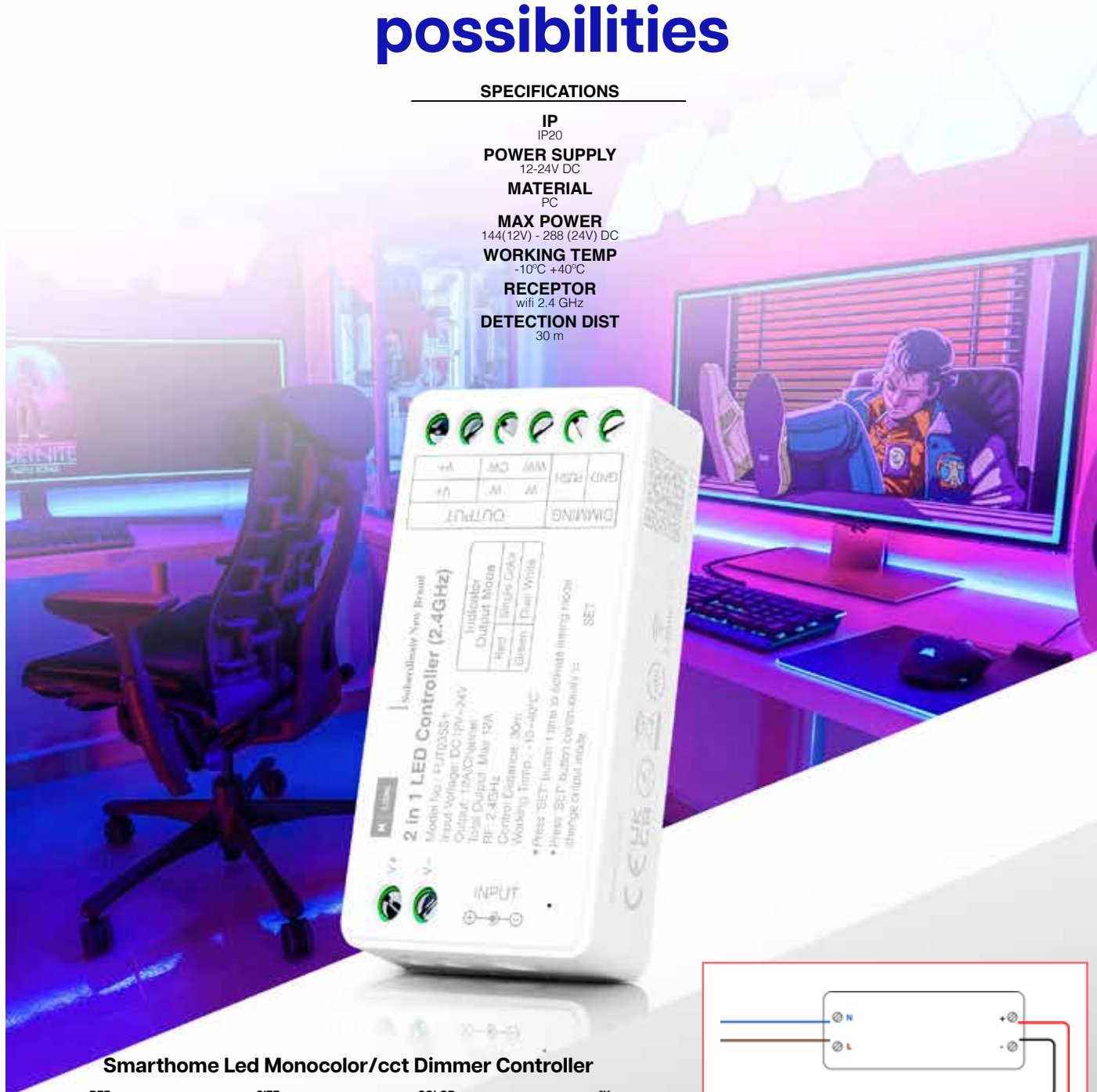

Smarthome Led Monocolor/cct Dimmer Controller

REF	SIZE	COLOR	°K
LM2082	17X36HX75 mm	Blanco	Monocolor / CCT
LM2083	17X36HX75 mm	Blanco	RGB / RGBW / RGB+CCT

Compatible accessories:



LM2088
Mando Rf Regulador Led
Rgb+Cct 4 Zonas



LM2087
Mando Rf Regulador Led
Monocolor 4 Zonas

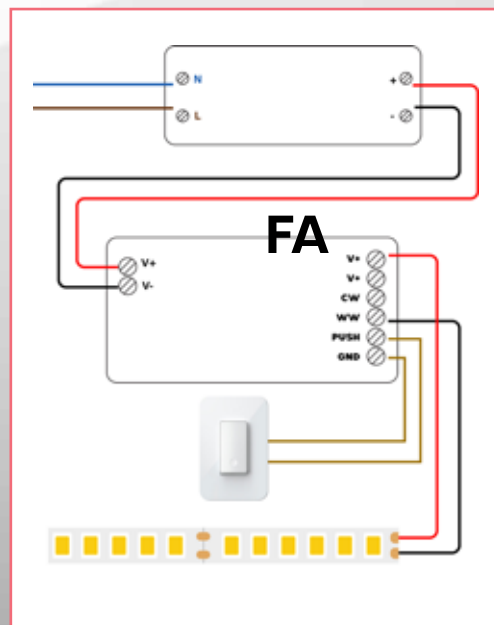

Mini Controller for RGBW LED Strips with IR Remote Control / Tuya Magic Home App



IP: IP20
POWER SUPPLY: 12-24V dc
MATERIAL: PC
MAX POWER: 144(12V) - 288 (24V) DC
WORKING TIME: -10°C +40°C
RECEPTOR: wifi 2.4 GHz

REF	SIZE	COLOR
LM2180	50X22X10H mm	Blanco / White



Compatible accessories:



LM2031
Adaptador de Corriente Para Tiras Led 60W 12Vdc



LM0017
Cable Conector Tira Led Macho



LM2030
Adaptador de Corriente Para Tiras Led 36W 12Vdc



LM2189
Adaptador de Corriente Para Tiras Led 60W 24Vdc

Mini SmartHome RGB LED Strip Controller with IR Remote / Tuya App Control



IP: IP20
POWER SUPPLY: 12-24V dc
MATERIAL: PC
MAX POWER: 72 (12V) - 144 (24V) DC
RECEPTOR: wifi 2.4 GHz

REF	SIZE	COLOR
LM2187	50X22X10H mm	Blanco / White



Compatible accessories:



LM2031
Adaptador de Corriente Para Tiras Led 60W 12Vdc



LM0017
Cable Conector Tira Led Macho



LM2030
Adaptador de Corriente Para Tiras Led 36W 12Vdc



LM2189
Adaptador de Corriente Para Tiras Led 60W 24Vdc

Dimmable Power Supply controlled by Tuya App. LED 200W 24VDC RGB+CCT



IP: IP20
POWER SUPPLY: 200-240v
OUTPUT: 24V DC
MATERIAL: Aluminio
RECEPTOR: Bluetooth Mesh 5.0

REF	W MAX	SIZE	COLOR
LM2256	200	230X49X29H mm	Negro / Black
LM2257	400	288X49X29H mm	Negro / Black



IP:
IP20
POWER SUPPLY:
100-240v ac
INTENSITY:
16A
MATERIAL:
Metal / PC
MAX POWER:
3520
RECEPTOR:
wifi 2.4 GHz

REF	SIZE	COLOR
LM9101	45X85H mm	Blanco / White



WIFI SMARTHOME PLUG 16A

La solución de sincronización se basa en el desarrollo del módulo de modo dual Wi-Fi y Bluetooth LE de alto rendimiento de Tuya.

Es compatible con enlaces de control dual para el control remoto de **Wi-Fi** y el control local de **Bluetooth**, y puede realizar una conmutación perfecta automática e inteligente, lo que puede ocurrir en entornos de red de **Wi-Fi** deficientes.

En el caso de fluctuaciones, aún se puede garantizar un control fluido del usuario, lo que puede mejorar en gran medida la experiencia del usuario.

Además, la solución admite puntos de función enriquecidos, como el control remoto por infrarrojos, la atenuación segmentada, el modo de no molestar, el biorritmo, etc.

- 16A
- Potencia max 3520
- Wifi 2.4 GHz

The synchronization solution is based on the development of Tuya's high-performance dual-mode Wi-Fi and Bluetooth LE module.

It is compatible with dual control links for remote **Wi-Fi** control and local **Bluetooth** control, and can perform seamless automatic and intelligent switching, which can occur in deficient **Wi-Fi** network environments.

In the case of fluctuations, smooth user control can still be guaranteed, greatly enhancing the user experience.

Additionally, the solution supports rich function points, such as infrared remote control, segmented dimming, do-not-disturb mode, biorhythm, etc.

- 16A
- Power max 3520
- Wifi 2.4 GHz

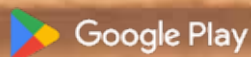

Simple Wifi Touch Switch



IP: IP20
POWER SUPPLY: 100-250V AC
MATERIAL: Cristal / PC
Intensity: 10A
DIMMABLE: Si
Installation: Empotrable
RECEPTOR: wifi 2.4 GHz

REF	SIZE	COLOR	Uso
BD-01WSCM-W	86X86X36 mm	White	Simple
BD-01WSCM-B	86X86X36 mm	Black	Simple
BD-02WSCM-W	86X86X36 mm	White	Double
BD-02WSCM-B	86X86X36 mm	Black	Double



Group Control

Administre de manera integral los sistemas de iluminación de sus propiedades, haciéndolas residencias inteligentes conectadas online, basadas en IoT con nuestra gama especializada de soluciones de hardware, SaaS y PaaS.

TUYA define un producto como un conjunto de dispositivos inteligentes con las mismas configuraciones y propiedades. La plataforma asigna automáticamente un ID de producto para identificar el producto.

La temperatura del color y el brillo se ajustarán automáticamente a diferentes horas del día de acuerdo con tu ritmo biológico. Durante el día, el brillo y la temperatura del color son altos para inhibir la secreción de melatonina, brindándote energía. Por la noche, el brillo y la temperatura del color se reducen para ayudar a relajarte y conciliar el sueño.

El modo de vacaciones se puede habilitar con un toque para crear un escenario que parezca que está en casa cuando en realidad no lo está, para proteger su hogar de robos.

Las soluciones ofrecen los modos de cine y música para iluminar la sala de estar, donde la familia pasa la mayor parte del tiempo junta y organiza fiestas, reuniones y otras actividades diarias importantes, brindándole una experiencia diferente.

El modo nocturno es especialmente adecuado para su uso en el dormitorio para que sea acogedor y relajante. Las soluciones también admiten luces nocturnas independientes con brillo ultra bajo, que son fáciles de usar por la noche y no perturbarán su sueño. Los modos de sueño y despertar desarrollados en base a la fotobiología pueden ayudarlo a conciliar el sueño rápidamente y despertarlo suavemente.

Comprehensively manage the lighting systems of your properties, turning them into connected smart homes online, based on IoT with our specialized range of hardware, SaaS, and PaaS solutions.

TUYA defines a product as a set of smart devices with the same configurations and properties. The platform automatically assigns a product ID to identify the product.

The color temperature and brightness will automatically adjust at different times of the day according to your biological rhythm. During the day, brightness and color temperature are high to inhibit melatonin secretion, providing you with energy. At night, brightness and color temperature are reduced to help you relax and fall asleep.

Vacation mode can be enabled with a touch to create a scenario that makes it appear as though you're at home when you're actually not, to protect your home from theft.

The solutions offer cinema and music modes to illuminate the living room, where the family spends most of their time together and organizes parties, gatherings, and other important daily activities, providing you with a different experience.

Night mode is especially suitable for use in the bedroom to make it cozy and relaxing. The solutions also support independent night lights with ultra-low brightness, which are easy to use at night and won't disturb your sleep. Sleep and wake modes developed based on photobiology can help you fall asleep quickly and wake up gently.





SMART LIFE

IOS / ANDROID



TUYA APP

IOS / ANDROID



ILINK APP

IOS / ANDROID



MAGIC HOME APP

IOS / ANDROID



- Controle de forma remota desde cualquier lugar
- Agregue y controle varios dispositivos a la vez con una aplicación
- Control por voz a través de Alexa o Google Home
- Interfuncionamiento de múltiples dispositivos inteligentes. Los dispositivos comienzan / dejan de funcionar automáticamente según la temperatura, la ubicación y la hora.
- Comparta dispositivos fácilmente entre miembros de la familia
- Reciba alertas en tiempo real para garantizar la seguridad.
- Conecte la aplicación a los dispositivos de forma fácil y rápida

- Remote control from anywhere
- Add and control multiple devices at once with one application
- Voice control via Alexa or Google Home
- Interoperability of multiple smart devices. Devices start/stop automatically based on temperature, location, and time.
- Easily share devices among family members
- Receive real-time alerts to ensure safety.
- Easily and quickly connect the application to devices



24. Bulb Led E27 G45



24. Bulb Led E27 G95



24. Bulb Led E27 T100



24. Bulb Led E27 Mosquito repellent



25. Bulb Led E27 R63



25. Bulb Led E27 Par30



25. Bulb Led Colours A60 E27 Rgbw with control remote



25. Bulb Led E14 G45



26. Bulb Led C37 E14



26. Bulb Led Filament E27 A60



26. Bulb Led Filament E27 G45



26. Bulb Led Filament E27 St64



27. Bulb Led Filament Spiral E27 St64



27. Bulb Led Filament Spiral E27 G125 Amber



27. Bulb Led Filament Spiral E27 Bottle



27. Bulb Led Filament Spiral E27 Bt180



28. Bulb Led Filament Spiral E27 G125 Ball



28. Bulb Led Filament Spiral E27 A165 Amber



28. Bulb Led Filament Spiral E27 A160



28. Bulb Led Filament E14 G45



29. Bulb Led Filament E27 A60 4W Amber



29. Bulb Led Filament E14 C35 Punta



30. Bulb Led Gu10 Cobpro



30. Bulb Led Gu10 Next Plus 6W Dimmable



30. Bulb Led Gu10 Smdpro



31. Bulb Led Gu10 Smd Plus



31. Bulb Led Mr16 Smd Plus



31. Bulb Led Colours Gu10 Rgbw with control remote



32. Bulb Led E14 Mini



32. Bulb Led G4 Cob



32. Bulb Led G9



32. Bulb Led R7S 118 mm



33. Bulb Led Star Gu10 Ar111



34. Circular Slim Series LED Panel



34. Square Slim Series LED Panel



36. Nickel CCT Circular LED Panel



36. Nickel CCT Square LED Panel



38. Slim Series Circular Surface Panel



38. Slim Series Square Surface Panel



40. Nickel Circular CCT Surface Panel



40. Nickel Square CCT Surface Panel



42. Circular LED Ceiling Light Ice



42. Circular LED Ceiling Light Dial



42. Circular LED Ceiling Light Sense

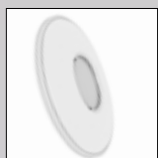

43. Circular LED Ceiling Light Bari CCT



43. Circular LED Ceiling Light Remo



43. Circular LED Ceiling Light Turin



43. LED Ceiling Light Magic Rgb+CCT



44. LED Ceiling Light Wood Round



45. LED Ceiling Light Wood Round



46. Circular LED Panel Sensor Light Series



46. Surface Mount Circular Panel Sensor Light Series



47. Kram CCT LED Downlight



48. LED Ceiling Light With Motion Sensor Halls



49. Motion Sensor Ceiling Light Nantes



50. Bless LED Downlight Spotlight



52. Downlight Led Luxtar



52. Downlight Led Lass



52. Downlight Led Pro Lass



53. Downlight Led Pro Lass 22W



54. Circular LED Downlight Serie Advance CCT



55. LED Downlight Spotlight Cobmon 7W



56. Adjustable LED Downlight Spotlight



57. LED Downlight Spotlight

Iluminación Interior



58. Downlight Led Dicle 3W



59. LED Downlight Spotlight Deep 5W CCT



60. LED Downlight Spotlight Road 7W IP54



61. LED Panel Serie Bure 60X60 No Flicker Driver Philips



61. LED Panel Serie Trielle 60X60 No Flicker



62. Rectangular LED Panel Bure Series 120X30

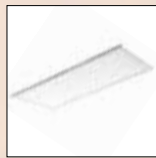

64. LED Panel Rectangular Serie Bure 120x60

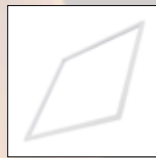

64. LED Panel de Marco Luminoso 42W No Flicker



65. T8 Ekran LED Tube One-Side Connection



65. T8 Ekran LED Tube Two-Side Connection



65. LED Fixture Slimline Fast



66. T8 1200mm Ekran LED Tube with Motion Sensor



67. LED Fixture Slimline Moments



67. LED Fixture Slimline Garaz



67. Linkable CCT Proline 600mm LED Waterproof Fixture



68. Waterproof Fixture for Two Platno LED Tubes



69. Linear Bar Trian



70. Barcelona Linear Bar 40W (UGR 19) CCT



72. Emergency LED 4W Narlux Autotest



72. Zovy LED Emergency Autotest



73. Zovy LED Emergency Autotest Permanent / Non-Permanent



74. Recessed LED Beacon With PIR Sensor Nomis Square



74. Recessed LED Beacon Nomis Square

Interior Lighting

Bulb Led E27 G45 / A60 / A70



IP:
IP20
BRIGHTNESS:
90 LM/W
ANGLE:
270°
MATERIAL:
Aluminium / PC
LIGHT SOURCE:
Smd 2835
POWER SUPPLY:
170-265V AC
DURABILITY:
15000 Hr
CRI:
80
FINISH:
Opal

REF	W	SIZE	COLOR	°K
LM7006	7	45X90H mm	Opal	6000K
LM7005	7	45X90H mm	Opal	4500K
LM7007	7	45X90H mm	Opal	3000K
LM7003	5	45X83H mm	Opal	6000K
LM7002	5	45X83H mm	Opal	4500K
LM7004	5	45X83H mm	Opal	3000K
LM7046	15	69X130H mm	Opal	6000K
LM7047	15	69X130H mm	Opal	4500K
LM7048	15	69X130H mm	Opal	3000K
LM7035	10	59X116H mm	Opal	6000K
LM7036	10	59X116H mm	Opal	4500K
LM7037	10	59X116H mm	Opal	3000K



Bulb Led E27 G95 / G125



IP:
IP20
ANGLE:
300°
MATERIAL:
Aluminium / PC
LIGHT SOURCE:
Smd 2835
POWER SUPPLY:
170-265V AC
DURABILITY:
15000 Hr
CRI:
80
FINISH:
Opal

REF	W	BRIGHTNESS	SIZE	COLOR	°K
LM7091	15	1350	95X138H mm	Blanco / White	6000K
LM7093	15	1350	95X138H mm	Blanco / White	4500K
LM7094	15	1350	95X138H mm	Blanco / White	3000K
LM7095	20	1800	118X156,5H mm	Blanco / White	6000K
LM7096	20	1800	118X156,5H mm	Blanco / White	4500K
LM7097	20	1800	118X156,5H mm	Blanco / White	3000K
LM7101	24	2490	120X158H mm	Blanco / White	6000K
LM7102	24	2490	120X158H mm	Blanco / White	4500K



Bulb Led E27 T100



IP:
IP20
BRIGHTNESS:
90 LM/W
ANGLE:
270°
MATERIAL:
Aluminium / PC
LIGHT SOURCE:
Smd 2835
POWER SUPPLY:
170-265V AC
DURABILITY:
15000 Hr
CRI:
80
FINISH:
Opal

REF	W	SIZE	COLOR	°K
LM7098	30	98X188H mm	Blanco / White	6000K
LM7100	50	125X221H mm	Blanco / White	6500K



Bulb Led E27 Mosquito repellent



IP:
IP20
BRIGHTNESS:
1280
ANGLE:
300°
MATERIAL:
Aluminium / PC
LIGHT SOURCE:
Smd 2835
POWER SUPPLY:
170-265V AC
DURABILITY:
30000 Hr
CRI:
80
FINISH:
Opal

REF	W	SIZE	COLOR	°K
LM9006	15	160HX90 mm	Gris / Grey	6000K



Bulb Led E27 R63 / R80 / R90



IP:
IP20
BRIGHTNESS:
90 LM/W
ANGLE:
120°
MATERIAL:
Led
LIGHT SOURCE:
Smd 2835
POWER SUPPLY:
170-265V AC
DURABILITY:
15000 Hr
CRI:
80
FINISH:
Opal

REF	W	SIZE	COLOR	°K
LM7081	6	50X87H mm	Blanco / White	6000K
LM7083	6	50X87H mm	Blanco / White	3000K
LM7084	9	63X100H mm	Blanco / White	6000K
LM7086	9	63X100H mm	Blanco / White	3000K
LM7090	15	90X116H mm	Blanco / White	6000K
LM7092	15	90X116H mm	Blanco / White	3000K
LM7087	12	80X115H mm	Blanco / White	6000K
LM7089	12	80X115H mm	Blanco / White	3000K



Bulb Led E27 Par30



IP:
IP20
BRIGHTNESS:
90 LM/W
ANGLE:
15°
MATERIAL:
Aluminium / PC
LIGHT SOURCE:
Smd 2835
POWER SUPPLY:
85-265V AC
DURABILITY:
15000 Hr
CRI:
80
FINISH:
Opal

REF	W	SIZE	COLOR	°K
LM7151	35	95X120H mm	Negro / Black	6000K
LM7152	35	95X120H mm	Negro / Black	4500K
LM7153	35	95X120H mm	Negro / Black	3000K



Bulb Led Colours A60 E27 Rgbw with control remote



IP:
IP20
BRIGHTNESS:
1000
ANGLE:
270°
MATERIAL:
Aluminium / PC
LIGHT SOURCE:
Smd 2385
POWER SUPPLY:
170-265V AC
DURABILITY:
30000 Hr
CRI:
80
FINISH:
Opal

REF	W	SIZE	COLOR	°K
LM7143	10	60X115H mm	Blanco / White	RGBW



Bulb Led E14 G45



IP:
IP20
BRIGHTNESS:
630
ANGLE:
270°
MATERIAL:
Aluminium / PC
LIGHT SOURCE:
Smd 2835
POWER SUPPLY:
170-265V AC
DURABILITY:
15000 Hr
CRI:
80
FINISH:
Opal

REF	W	SIZE	COLOR	°K
LM7012	7	45X70H mm	Blanco / White	6000 K
LM7011	7	45X70H mm	Blanco / White	4500 K
LM7013	7	45X70H mm	Blanco / White	3000 K



Bulb Led C37 E14



IP:
IP20
BRIGHTNESS:
500
ANGLE:
270°
MATERIAL:
Aluminium / PC
LIGHT SOURCE:
Led
POWER SUPPLY:
170-265V AC
DURABILITY:
15000 Hr
CRI:
80
FINISH:
Opal

REF	W	SIZE	COLOR	°K
LM7021	6	37X100H mm	Blanco / White	6000K
LM7022	6	37X100H mm	Blanco / White	4500K
LM7023	6	37X100H mm	Blanco / White	3000K



Bulb Led Filament E27 G45



IP:
IP20
BRIGHTNESS:
350
ANGLE:
330°
MATERIAL:
Cristal
LIGHT SOURCE:
Filament Led
POWER SUPPLY:
170-265V AC
DURABILITY:
30000 Hr
CRI:
80
FINISH:
Amber

REF	W	SIZE	COLOR	°K
LM8551	4	45X73H mm	Ambar / Amber	2300K



Bulb Led Filament E27 G80 / G95 / G125



IP:
IP20
BRIGHTNESS:
500
ANGLE:
330°
MATERIAL:
Cristal
LIGHT SOURCE:
Filament Led
POWER SUPPLY:
170-265V AC
DURABILITY:
30000 Hr
CRI:
80
FINISH:
Amber

REF	W	SIZE	COLOR	°K
LM8557	6	80X120H mm	Ambar / Amber	2300K
LM8559	6	95X135H mm	Ambar / Amber	2300K
LM8561	6	125X176H mm	Ambar / Amber	2300K



Bulb Led Filament E27 St64



IP:
IP20
BRIGHTNESS:
500
ANGLE:
330°
MATERIAL:
Cristal
LIGHT SOURCE:
Filament Led
POWER SUPPLY:
170-265V AC
DURABILITY:
30000 Hr
CRI:
80
FINISH:
Amber

REF	W	SIZE	COLOR	°K
LM8563	6	64X148H mm	Ambar / Amber	2300K



Bulb Led Filament Spiral E27 St64



IP:
IP20
BRIGHTNESS:
500
ANGLE:
330°
MATERIAL:
Cristal
LIGHT SOURCE:
Filament Led
POWER SUPPLY:
170-265V AC
DURABILITY:
30000 Hr
CRI:
80
FINISH:
Amber

REF	W	SIZE	COLOR	°K
LM8571	6	64X140H mm	Ambar / Amber	2300K



Bulb Led Filament Spiral E27 G125 Amber



IP:
IP20
BRIGHTNESS:
350
ANGLE:
330°
MATERIAL:
Cristal
LIGHT SOURCE:
Filament Led
POWER SUPPLY:
170-265V AC
DURABILITY:
30000 Hr
CRI:
80
FINISH:
Amber

REF	W	SIZE	COLOR	°K
LM8574	4	125X176H mm	Ambar / Amber	2300K
LM8572	4	200X280H mm	Ambar / Amber	2300K



Bulb Led Filament Spiral E27 Bottle



IP:
IP20
BRIGHTNESS:
350
ANGLE:
330°
MATERIAL:
Cristal
LIGHT SOURCE:
Filament Led
POWER SUPPLY:
170-265V AC
DURABILITY:
30000 Hr
CRI:
80
FINISH:
Amber

REF	W	SIZE	COLOR	°K
LM8578	4	70X270H mm	Ambar / Amber	2300K
LM8579	4	62X170H mm	Ambar / Amber	2300K



Bulb Led Filament Spiral E27 Bt180



IP:
IP20
BRIGHTNESS:
350
ANGLE:
330°
MATERIAL:
Cristal
LIGHT SOURCE:
Filament Led
POWER SUPPLY:
170-265V AC
DURABILITY:
30000 Hr
CRI:
80
FINISH:
Amber

REF	W	SIZE	COLOR	°K
LM8577	4	180X350H mm	Ambar / Amber	2300K



Bulb Led Filament Spiral E27 G125 Ball



IP:
IP20
BRIGHTNESS:
350
ANGLE:
330°
MATERIAL:
Cristal
LIGHT SOURCE:
Filament Led
POWER SUPPLY:
170-265V AC
DURABILITY:
30000 Hr
CRI:
80
FINISH:
Amber

REF	W	SIZE	COLOR	°K
LM8573	4	125X170H mm	Ambar / Amber	2300K



Bulb Led Filament Spiral E27 A165 Amber



IP:
IP20
BRIGHTNESS:
350
ANGLE:
330°
MATERIAL:
Cristal
LIGHT SOURCE:
Filament Led
POWER SUPPLY:
170-265V AC
DURABILITY:
30000 Hr
CRI:
80
FINISH:
Amber

REF	W	SIZE	COLOR	°K
LM8576	4	165X275H mm	Ambar / Amber	2300K



Bulb Led Filament Spiral E27 A160



IP:
IP20
BRIGHTNESS:
350
ANGLE:
330°
MATERIAL:
Cristal
LIGHT SOURCE:
Filament Led
POWER SUPPLY:
170-265V AC
DURABILITY:
30000 Hr
CRI:
80
FINISH:
Amber

REF	W	SIZE	COLOR	°K
LM8575	4	160X270H mm	Ambar / Amber	2300K



Bulb Led Filament E14 G45



IP:
IP20
BRIGHTNESS:
350
ANGLE:
330°
MATERIAL:
Cristal
LIGHT SOURCE:
Filament Led
POWER SUPPLY:
170-265V AC
DURABILITY:
30000 Hr
CRI:
80
FINISH:
Amber

REF	W	SIZE	COLOR	°K
LM8552	4	45X73H mm	Ambar / Amber	2300K



Bulb Led Filament E14 C35 4W Amber



IP:
IP20
BRIGHTNESS:
350
ANGLE:
330°
MATERIAL:
Cristal
LIGHT SOURCE:
Filament Led
POWER SUPPLY:
170-265V AC
DURABILITY:
30000 Hr
CRI:
80
FINISH:
Amber

REF	W	SIZE	COLOR	°K
LM8553	4	35X100H mm	Ambar / Amber	2300K



Bulb Led Filament E14 C35 Punta



IP:
IP20
BRIGHTNESS:
350
ANGLE:
330°
MATERIAL:
Cristal
LIGHT SOURCE:
Filament Led
POWER SUPPLY:
170-265V AC
DURABILITY:
30000 Hr
CRI:
80
FINISH:
Amber

REF	W	SIZE	COLOR	°K
LM8564	4	35X110H mm	Ambar / Amber	2300K



Bulb Led Gu10 Cobpro



IP:
IP20
BRIGHTNESS:
630
ANGLE:
12°
MATERIAL:
Ceramica/PC
LIGHT SOURCE:
Cob Led
POWER SUPPLY:
220-240V AC
DURABILITY:
30000 Hr
CRI:
80
FINISH:
Opal

REF	W	SIZE	COLOR	*K
LM7175	8	50X57H mm	Blanco / White	4500K
LM7176	8	50X57H mm	Blanco / White	3000K



Bulb Led Gu10 Glass



IP:
IP20
BRIGHTNESS:
540
ANGLE:
38°
MATERIAL:
Cristal/PC
LIGHT SOURCE:
Smd Led
POWER SUPPLY:
220-240V AC
DURABILITY:
25000 Hr
CRI:
80
FINISH:
Opal

REF	W	SIZE	COLOR	*K
LM7177	7	50X53H mm	Blanco / White	6000K
LM7178	7	50X53H mm	Blanco / White	4500K
LM7179	7	50X53H mm	Blanco / White	3000K



Bulb Led Gu10 Next Plus 6W Dimmable



IP:
IP20
BRIGHTNESS:
480
ANGLE:
38°
MATERIAL:
Termoplastico/PC
LIGHT SOURCE:
Smd Led
POWER SUPPLY:
220-240V AC
DURABILITY:
15000 Hr
CRI:
80
FINISH:
Opal
DIMMABLE:
Triac

REF	W	SIZE	COLOR	*K
LM7111	6	50X55H mm	Blanco / White	6000K
LM7112	6	50X55H mm	Blanco / White	4500K
LM7113	6	50X55H mm	Blanco / White	3000K



Bulb Led Gu10 Smdpro



IP:
IP20
BRIGHTNESS:
930
ANGLE:
120°
MATERIAL:
Ceramica/PC
LIGHT SOURCE:
Smd Led
POWER SUPPLY:
220-240V AC
DURABILITY:
30000 Hr
CRI:
80
FINISH:
Opal

REF	W	SIZE	COLOR	*K
LM7171	9	50X57H mm	Blanco / White	6000K
LM7172	9	50X57H mm	Blanco / White	4500K
LM7173	9	50X57H mm	Blanco / White	3000K



Bulb Led Gu10 Smd Plus



IP:
IP20
BRIGHTNESS:
530
ANGLE:
100°
MATERIAL:
Termoplastico/PC
LIGHT SOURCE:
Smd Led
POWER SUPPLY:
220-240V AC
DURABILITY:
15000 Hr
CRI:
80
FINISH:
Opal

REF	W	SIZE	COLOR	°K
LM7074	7	49,3X55H mm	Blanco / White	6000K
LM7075	7	49,3X55H mm	Blanco / White	4500K
LM7076	7	49,3X55H mm	Blanco / White	3000K



Bulb Led Mr16 Smd Plus



IP:
IP20
BRIGHTNESS:
530
ANGLE:
120°
MATERIAL:
Aluminium / PC
LIGHT SOURCE:
Led
POWER SUPPLY:
12V ADC
DURABILITY:
15000 Hr
CRI:
80
FINISH:
Opal

REF	W	SIZE	COLOR	°K
LM7055	6	50X55H mm	Blanco / White	6500K
LM7056	6	50X55H mm	Blanco / White	4500K
LM7057	6	50X55H mm	Blanco / White	3000K



Bulb Led Colours Gu10 Rgbw with control remote



IP:
IP20
BRIGHTNESS:
350
ANGLE:
38°
MATERIAL:
Aluminium / PC
LIGHT SOURCE:
Led
POWER SUPPLY:
170-265V AC
DURABILITY:
30000 Hr
CRI:
80
FINISH:
Opal

REF	W	SIZE	COLOR	°K
LM7142	5	50X56H mm	Blanco / White	RGBW



Included Remote control



Bulb Led E14 Mini



IP:
IP40
BRIGHTNESS:
420
ANGLE:
300°
MATERIAL:
Epoxy
LIGHT SOURCE:
Smd 2835
POWER SUPPLY:
170-265V AC
DURABILITY:
30000 Hr
CRI:
80
FINISH:
Translucido

REF	W	SIZE	COLOR	°K
LM3313	5	15X55H mm	Blanco / White	6000K
LM3314	5	15X55H mm	Blanco / White	3000K



Bulb Led G4 Cob



IP:
IP40
BRIGHTNESS:
240
ANGLE:
330°
MATERIAL:
Epoxy
LIGHT SOURCE:
Cob
POWER SUPPLY:
12V DC
DURABILITY:
40000 Hr
CRI:
80
FINISH:
Transparente

REF	W	SIZE	COLOR	°K
LM3301	3	11X38H mm	Blanco / White	6000K
LM3302	3	11X38H mm	Blanco / White	3000K



Bulb Led G9



IP:
IP20
BRIGHTNESS:
420
ANGLE:
330°
MATERIAL:
Termoplastico
LIGHT SOURCE:
Smd 2835
POWER SUPPLY:
170-265V AC
DURABILITY:
20000 Hr
CRI:
80
FINISH:
Transparente

REF	W	SIZE	COLOR	°K
LM7120	5	15X50H mm	Blanco / White	6000K
LM7121	5	15X50H mm	Blanco / White	4500K
LM7122	5	15X50H mm	Blanco / White	3000K



Bulb Led R7S 118 mm



IP:
IP20
BRIGHTNESS:
1000
ANGLE:
330°
MATERIAL:
Termoplastico
LIGHT SOURCE:
Smd 2835
POWER SUPPLY:
170-265V ADC
DURABILITY:
20000 Hr
CRI:
80
FINISH:
Opal

REF	W	SIZE	COLOR	°K
LM7126	10	20X118H mm	Blanco / White	6000K
LM7127	10	20X118H mm	Blanco / White	4500K
LM7128	10	20X118H mm	Blanco / White	3000K



Bulb Led Star Gu10 Ar111



IP:
IP20
BRIGHTNESS:
1200
ANGLE:
24°
MATERIAL:
Cerámica/PC
LIGHT SOURCE:
Cob Led
POWER SUPPLY:
220-240V ADC
DURABILITY:
30000 Hr
CRI:
80
FINISH:
Blanco / White

REF	W	SIZE	COLOR	°K
LM7155	15	110X75H mm	Blanco / White	4500K
LM7156	15	110X75H mm	Blanco / White	3000K



Bulb Led Star Gu10 Ar111

Introducimos la Bulb Led GU10 AR111 Star, una opción sofisticada que combina rendimiento lumínico de alto nivel con diseño estilizado. Diseñada para brindar una iluminación potente y duradera, la Star destaca por sus características técnicas avanzadas y su construcción cuidadosamente seleccionada.

Potencia Luminosa de 1200 Lúmenes: La Bulb Led GU10 AR111 Star ofrece una sorprendente salida de luz de 1200 lúmenes, asegurando una iluminación brillante y eficiente para cualquier espacio.

Ángulo de Iluminación de 24 grados: Con un ángulo de iluminación de 24°, la Star dirige la luz de manera precisa y focalizada, perfecta para resaltar áreas específicas y crear ambientes acogedores.

Carcasa de Cerámica y PC: Fabricada con cerámica y policarbonato (PC), la Star garantiza durabilidad y disipación eficiente del calor. Este diseño asegura una bombilla resistente y eficaz, adaptándose a diversas condiciones de uso.

Fuente Lumínica COB LED de Alta Calidad: Equipada con tecnología COB LED, la Star ofrece una fuente lumínica confiable y eficiente. Con un índice de reproducción cromática (CRI) de 80, garantiza la representación fiel de los colores en cualquier entorno.

Vida Útil de 30,000 Horas: Con una vida útil de 30,000 horas, la Star reduce la necesidad de reemplazos frecuentes, proporcionando una iluminación constante y fiable a lo largo del tiempo.

We introduce the GU10 AR111 Star LED Bulb, a sophisticated option that combines high-level luminous performance with a sleek design. Designed to provide powerful and long-lasting illumination, the Star stands out for its advanced technical features and carefully selected construction.

Luminous Power of 1200 Lumens: The GU10 AR111 Star LED Bulb offers a stunning light output of 1200 lumens, ensuring bright and efficient illumination for any space.

24-Degree Beam angle: With a 24° beam angle, the Star directs light precisely and focused, perfect for highlighting specific areas and creating cozy atmospheres.

Ceramic and PC Housing: Manufactured with ceramic and polycarbonate (PC), the Star ensures durability and efficient heat dissipation. This design ensures a resilient and effective bulb, adapting to various usage conditions.

High-Quality SMD LED light source: Equipped with COB LED technology, the Star offers a reliable and efficient light source. With a color Rendering Index (CRI) of 80, it ensures faithful color representation in any environment.

30,000 Hour Lifespan: With a lifespan of 30,000 hours, the Star reduces the need for frequent replacements, providing consistent and reliable illumination over time.

Circular Slim Series LED Panel



IP:
IP20
BRIGHTNESS:
100 LM/W
ANGLE:
120°
MATERIAL:
Aluminio
LIGHT SOURCE:
Smd 2835
POWER SUPPLY:
170-265V AC
DURABILITY:
30000 Hr
CRI:
80
FINISH:
Opal
WORKING TEMP:
-20°C ~ + 45°C

REF	W	CUT	SIZE	COLOR	°K
LM5560	5	70 mm	85X10H mm	Blanco / White	6000K
LM5561	5	70 mm	85X10H mm	Blanco / White	4500K
LM5562	5	70 mm	85X10H mm	Blanco / White	3000K
LM5201	6	105 mm	120X19H mm	Blanco / White	6000K
LM5202	6	105 mm	120X19H mm	Blanco / White	4500K
LM5203	6	105 mm	120X19H mm	Blanco / White	3000K
LM5204	9	135 mm	145X20H mm	Blanco / White	6000K
LM5205	9	135 mm	145X20H mm	Blanco / White	4500K
LM5206	9	135 mm	145X20H mm	Blanco / White	3000K
LM5207	12	150 mm	170X10H mm	Blanco / White	6000K
LM5208	12	150 mm	170X10H mm	Blanco / White	4500K
LM5209	12	150 mm	170X10H mm	Blanco / White	3000K
LM5210	20	200 mm	220X10H mm	Blanco / White	6000K
LM5211	20	200 mm	220X10H mm	Blanco / White	4500K
LM5212	20	200 mm	220X10H mm	Blanco / White	3000K
LM5213	25	280 mm	295X20H mm	Blanco / White	6000K
LM5214	25	280 mm	295X20H mm	Blanco / White	4500K
LM5215	25	280 mm	295X20H mm	Blanco / White	3000K



Compatible accessories:



LM2128
Kit de Conversion de Emergencia Hasta 20W



KB0008
Driver Downlight LED Panel 9W



KB0007
Driver Downlight LED Panel 6W



KB0011
Driver Downlight LED Panel 25W



KB0009
Driver Downlight LED Panel 12W



KB0010
Driver Downlight LED Panel 20W

Square Slim Series LED Panel



IP:
IP20
BRIGHTNESS:
100 LM/W
ANGLE:
120°
MATERIAL:
Aluminio
LIGHT SOURCE:
Smd 2835
POWER SUPPLY:
170-265V AC
DURABILITY:
30000 Hr
CRI:
80
FINISH:
Opal
WORKING TEMP:
-20°C ~ + 45°C

REF	W	CUT	SIZE	COLOR	°K
LM5220	6	105X105 mm	117X117X10H mm	Blanco / White	6000K
LM5221	6	105X105 mm	117X117X10H mm	Blanco / White	4500K
LM5222	6	105X105 mm	117X117X10H mm	Blanco / White	3000K
LM5226	12	155X155 mm	170X170X20H mm	Blanco / White	6000K
LM5227	12	155X155 mm	170X170X20H mm	Blanco / White	4500K
LM5228	12	155X155 mm	170X170X20H mm	Blanco / White	3000K
LM5229	20	205X205 mm	220X220X20H mm	Blanco / White	6000K
LM5230	20	205X205 mm	220X220X20H mm	Blanco / White	4500K
LM5231	20	205X205 mm	220X220X20H mm	Blanco / White	4500K
LM5232	25	285X285 mm	290X290X10H mm	Blanco / White	3000K
LM5233	25	285X285 mm	290X290X10H mm	Blanco / White	6000K
LM5234	25	285X285 mm	290X290X10H mm	Blanco / White	4500K



Compatible accessories:



LM2128
Kit de Conversion de Emergencia Hasta 20W



KB0008
Driver Downlight LED Panel 9W



KB0007
Driver Downlight LED Panel 6W



KB0011
Driver Downlight LED Panel 25W



KB0009
Driver Downlight LED Panel 12W



KB0010
Driver Downlight LED Panel 20W

Recessed Panels

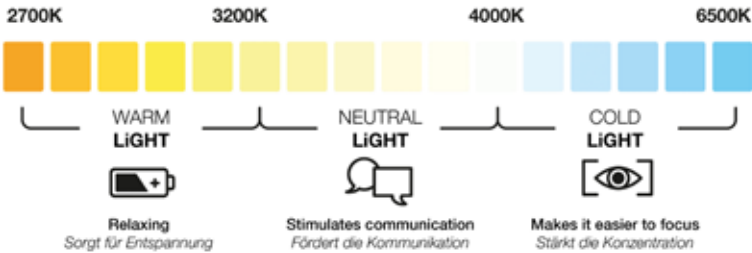
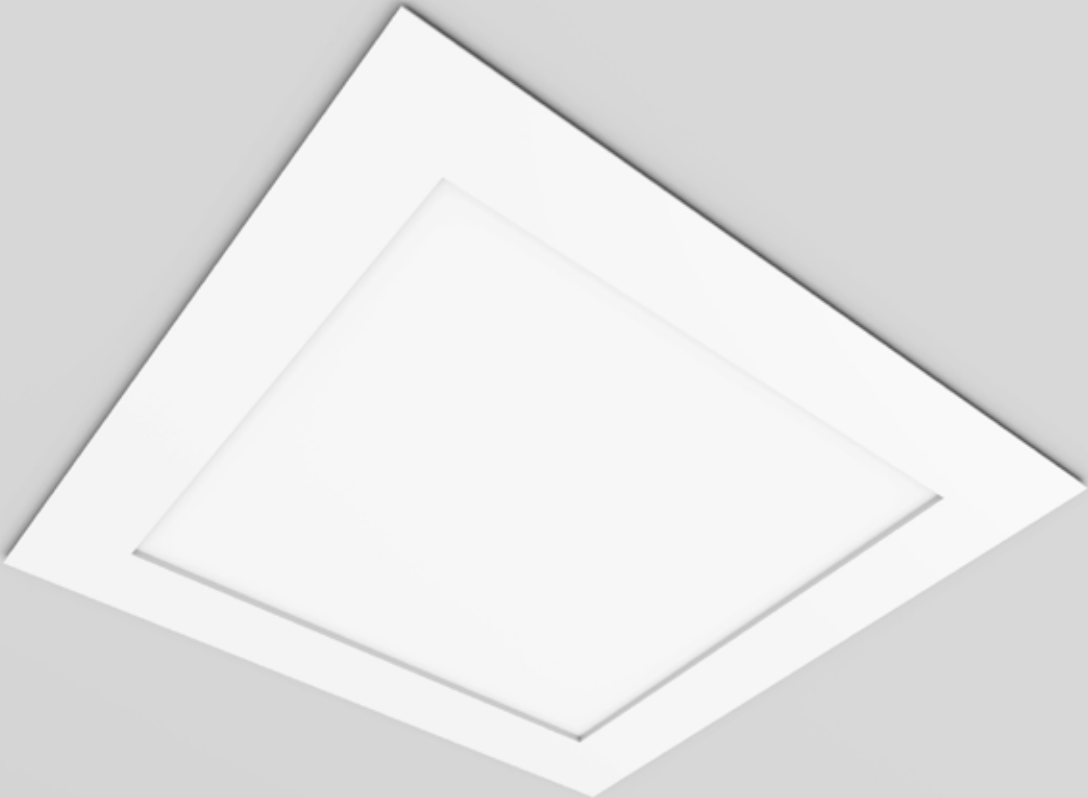

Serie Slim

Nickel CCT Circular LED Panel



IP:
IP20
BRIGHTNESS:
100 LM/W
ANGLE:
120°
MATERIAL:
Aluminio
LIGHT SOURCE:
Smd 2835
POWER SUPPLY:
170-265V ADC
DURABILITY:
30000 Hr
CRI:
80
FINISH:
Niquel

REF	W	CUT	SIZE	COLOR	°K
LM5501	6	110 mm	120X120X30H mm	Niquel	CCT
LM5507	12	150 mm	170X170X20H mm	Niquel	CCT
LM5520	20	205 mm	225X225X20H mm	Niquel	CCT
LM5523	25	280 mm	295X295X20H mm	Niquel	CCT



Includes Swift CCT

Compatible accessories:



LM2128
Kit de Conversion de Emergencia Hasta 20W



KB0008
Driver Downlight LED Panel 9W



KB0007
Driver Downlight LED Panel 6W



KB0011
Driver Downlight LED Panel 25W



KB0009
Driver Downlight LED Panel 12W



KB0010
Driver Downlight LED Panel 20W

Nickel CCT Square LED Panel



IP:
IP20
BRIGHTNESS:
100 LM/W
ANGLE:
120°
MATERIAL:
Aluminio
LIGHT SOURCE:
Smd 2835
POWER SUPPLY:
170-265V ADC
DURABILITY:
30000 Hr
CRI:
80
FINISH:
Niquel

REF	W	CUT	SIZE	COLOR	°K
LM5508	12	155X155 mm	172X172X20H mm	Niquel	CCT
LM5521	20	205X205 mm	225X225X20H mm	Niquel	CCT
LM5524	25	285X285 mm	290X290X20H mm	Niquel	CCT



Includes Swift CCT

Compatible accessories:



LM2128
Kit de Conversion de Emergencia Hasta 20W



KB0008
Driver Downlight LED Panel 9W



KB0007
Driver Downlight LED Panel 6W



KB0011
Driver Downlight LED Panel 25W



KB0009
Driver Downlight LED Panel 12W



KB0010
Driver Downlight LED Panel 20W

Recessed Panels

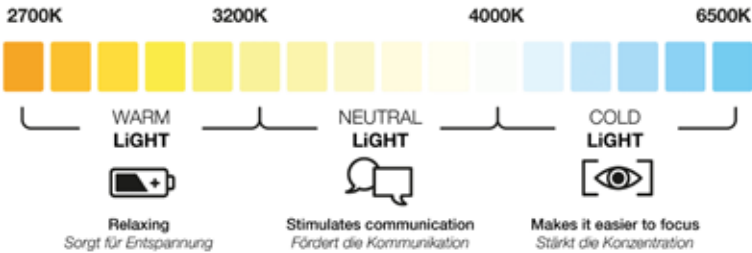

Series Slim Niquel CCT

Slim Series Circular Surface Panel



IP:
IP20
BRIGHTNESS:
100 LM/W
ANGLE:
120°
MATERIAL:
Aluminio
LIGHT SOURCE:
Smd 2835
POWER SUPPLY:
170-265V AC
DURABILITY:
30000 Hr
CRI:
80

REF	W	SIZE	COLOR	*K
LM5564	5	80X32H mm	Blanco / White	6000K
LM5565	5	80X32H mm	Blanco / White	4500K
LM5566	5	80X32H mm	Blanco / White	3000K
LM5289	6	110X28H mm	Blanco / White	6000K
LM5290	6	110X28H mm	Blanco / White	4500K
LM5291	6	110X28H mm	Blanco / White	3000K
LM5240	12	170X28H mm	Blanco / White	6000K
LM5241	12	170X28H mm	Blanco / White	4500K
LM5242	12	170X28H mm	Blanco / White	3000K
LM5243	20	210X28H mm	Blanco / White	6000K
LM5244	20	210X28H mm	Blanco / White	4500K
LM5245	20	210X28H mm	Blanco / White	3000K
LM5246	25	285X28H mm	Blanco / White	6000K
LM5247	25	285X28H mm	Blanco / White	4500K
LM5248	25	285X28H mm	Blanco / White	3000K



Compatible accessories:



LM2128
Kit de Conversion de Emergencia Hasta 20W



KB0008
Driver Downlight LED Panel 9W



KB0007
Driver Downlight LED Panel 6W



KB0011
Driver Downlight LED Panel 25W



KB0009
Driver Downlight LED Panel 12W



KB0010
Driver Downlight LED Panel 20W

Slim Series Square Surface Panel



IP:
IP20
BRIGHTNESS:
100 LM/W
ANGLE:
120°
MATERIAL:
Aluminio
LIGHT SOURCE:
Smd 2835
POWER SUPPLY:
170-265V AC
DURABILITY:
30000 Hr
CRI:
80

REF	W	SIZE	COLOR	*K
LM5250	12	170X28H mm	Blanco / White	6000K
LM5251	12	170X28H mm	Blanco / White	4500K
LM5252	12	170X28H mm	Blanco / White	3000K
LM5253	20	225X27H mm	Blanco / White	6000K
LM5254	20	225X27H mm	Blanco / White	4500K
LM5255	20	225X27H mm	Blanco / White	3000K
LM5256	25	285X40H mm	Blanco / White	6000K
LM5257	25	285X40H mm	Blanco / White	4500K
LM5258	25	285X40H mm	Blanco / White	3000K



Compatible accessories:



LM2128
Kit de Conversion de Emergencia Hasta 20W



KB0008
Driver Downlight LED Panel 9W



KB0007
Driver Downlight LED Panel 6W



KB0011
Driver Downlight LED Panel 25W



KB0009
Driver Downlight LED Panel 12W



KB0010
Driver Downlight LED Panel 20W

Surface Panels

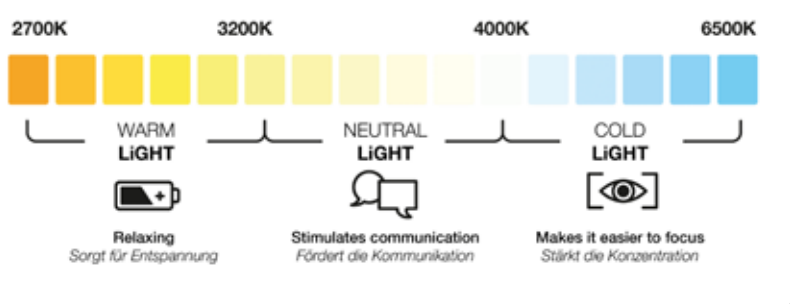

Serie Slim

Nickel Circular CCT Surface Panel



IP:
IP20
BRIGHTNESS:
100 LM/W
ANGLE:
120°
MATERIAL:
Aluminio
LIGHT SOURCE:
Smd Led
POWER SUPPLY:
170-265V AC
DURABILITY:
30000 Hr
CRI:
80

REF	W	SIZE	COLOR	°K
LM5537	6	120X35H mm	Niquel	CCT
LM5540	12	170X40H mm	Niquel	CCT
LM5543	20	225X32H mm	Niquel	CCT
LM5546	25	300X35H mm	Niquel	CCT



Compatible accessories:



LM2128
Kit de Conversion de Emergencia Hasta 20W



KB0008
Driver Downlight LED Panel 9W



KB0007
Driver Downlight LED Panel 6W



KB0011
Driver Downlight LED Panel 25W



KB0009
Driver Downlight LED Panel 12W



KB0010
Driver Downlight LED Panel 20W

Nickel Square CCT Surface Panel



IP:
IP44
BRIGHTNESS:
100 LM/W
ANGLE:
120°
MATERIAL:
Aluminio
LIGHT SOURCE:
Smd Led
POWER SUPPLY:
170-265V AC
DURABILITY:
30000 Hr
CRI:
80

REF	W	SIZE	COLOR	°K
LM5541	12	170X170X40H mm	Niquel	CCT
LM5544	20	225X225X35H mm	Niquel	CCT
LM5547	25	300X300X35H mm	Niquel	CCT



Compatible accessories:



LM2128
Kit de Conversion de Emergencia Hasta 20W



KB0008
Driver Downlight LED Panel 9W



KB0007
Driver Downlight LED Panel 6W



KB0011
Driver Downlight LED Panel 25W



KB0009
Driver Downlight LED Panel 12W



KB0010
Driver Downlight LED Panel 20W

Surface Panels

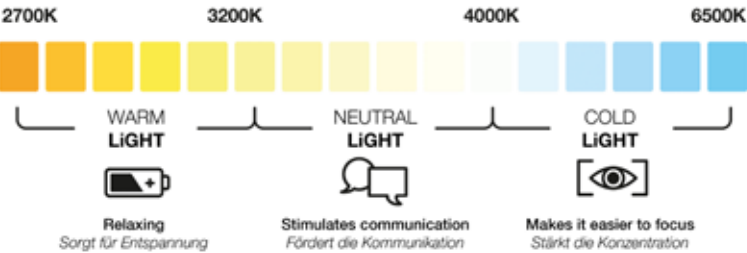

Series Slim Niquel CCT

Circular LED Ceiling Light Ice



IP:
IP20
BRIGHTNESS:
83 LM/W
ANGLE:
180°
MATERIAL:
Metal/PC
LIGHT SOURCE:
Epistar
POWER SUPPLY:
170-265V AC
DURABILITY:
170-265V AC
30000 Hr
CRI:
80

REF	W	SIZE	COLOR	°K
LM8207	36	390X65 mm	Blanco / White	6000K
LM8208	36	390X65 mm	Blanco / White	4500K
LM8210	24	390X65 mm	Blanco / White	6000K
LM8211	24	390X65 mm	Blanco / White	4500K



Illuminación Interior / Plafones LED - Interior Lighting / LED Ceiling Lights

Circular LED Ceiling Light Dial



IP:
IP20
BRIGHTNESS:
83 LM/W
ANGLE:
180°
MATERIAL:
Metal/PC
LIGHT SOURCE:
Epistar
POWER SUPPLY:
170-265V AC
DURABILITY:
170-265V AC
30000 Hr
CRI:
80

REF	W	SIZE	COLOR	°K
LM8204	24	340X65 mm	Blanco / White	6000K
LM8205	24	340X65 mm	Blanco / White	4500K
LM8201	36	390X65 mm	Blanco / White	6000K
LM8202	36	390X65 mm	Blanco / White	4500K



Compatible accessories:



LM2128
Kit de Conversion de
Emergencia Hasta 20W

Illuminación Interior / Plafones LED - Interior Lighting / LED Ceiling Lights

Circular LED Ceiling Light Sense



IP:
IP44
BRIGHTNESS:
100 LM/W
ANGLE:
120°
MATERIAL:
Aluminium / PC
LIGHT SOURCE:
Smd Led
POWER SUPPLY:
180-260V AC
DURABILITY:
30000 Hr
CRI:
80

REF	W	SIZE	COLOR	°K
LM8251	15	230X45H mm	Blanco / White	6000K
LM8252	15	230X45H mm	Blanco / White	4500K
LM8254	30	300X50H mm	Blanco / White	6000K
LM8255	30	300X50H mm	Blanco / White	4500K
LM8257	40	385X48H mm	Blanco / White	6000K
LM8258	40	385X48H mm	Blanco / White	4500K
LM8260	50	480X68H mm	Blanco / White	6000K
LM8261	50	480X68H mm	Blanco / White	4500K



Compatible accessories:



LM2128
Kit de Conversion de
Emergencia Hasta 20W

Circular LED Ceiling Light Bari CCT



IP:
IP20
BRIGHTNESS:
3600
ANGLE:
180°
MATERIAL:
PC
LIGHT SOURCE:
Epistar
POWER SUPPLY:
170-265V AC
DURABILITY:
30000 Hr
CRI:
80

REF	W	SIZE	COLOR	°K
LM8232	40	400X90H mm	Blanco / White	CCT



Included
Remote control

Iluminación Interior / Plafones LED - Interior Lighting / LED Ceiling Lights

Circular LED Ceiling Light Remo



IP:
IP20
BRIGHTNESS:
3600
ANGLE:
180°
MATERIAL:
PC
LIGHT SOURCE:
Epistar
POWER SUPPLY:
170-265V AC
DURABILITY:
30000 Hr
CRI:
80

REF	W	SIZE	COLOR	°K
LM8234	40	385X75H mm	Blanco / White	CCT



Included
Remote control

Iluminación Interior / Plafones LED - Interior Lighting / LED Ceiling Lights

Circular LED Ceiling Light Turin



IP:
IP20
BRIGHTNESS:
3600
ANGLE:
180°
MATERIAL:
Aluminium / PC
LIGHT SOURCE:
Epistar
POWER SUPPLY:
170-265V AC
DURABILITY:
30000 Hr
CRI:
80

REF	W	SIZE	COLOR	°K
LM8231	40	400X90H mm	Blanco / White	CCT



Included
Remote control

Iluminación Interior / Plafones LED / Plafones LED con Altavoz - Interior Lighting / LED Ceiling Lights / LED Ceiling Lights with Speaker

LED Ceiling Light Magic Rgb+CCT



IP:
IP20
BRIGHTNESS:
100 LM/W
ANGLE:
120°
MATERIAL:
Aluminium / PC
LIGHT SOURCE:
Smd 5050
POWER SUPPLY:
170-265V AC
DURABILITY:
25000 Hr
CRI:
80

REF	W	SIZE	COLOR	°K
LM6619	30	380X45H mm	Blanco / White	RGB+CCT
LM6609	36	500X45H mm	Blanco / White	RGB+CCT



Included
Remote control

LED Ceiling Light Wood Round



IP:
IP20
BRIGHTNESS:
2400
ANGLE:
120°
MATERIAL:
Aluminium / PC
LIGHT SOURCE:
Smd Led
POWER SUPPLY:
175-265V AC
CRI:
80
DIMMABLE:
Si

REF	W	SIZE	COLOR	*K
LM8283	24	300X50H mm	Negro / Black	CCT
LM8284	24	300X50H mm	Blanco / White	CCT
LM8285	24	300X50H mm	Gris / Grey	CCT



Included
Remote control

Regulation CCT



Regulation CCT



Illuminación Interior / Plafones LED / Plafones LED Circulares / Plafones LED de Diseño
 Interior Lighting / LED Ceiling Lights / Circular LED Ceiling Lights / Design LED Ceiling Lights

www.ledme-europa.com

LED Ceiling Light Wood Round

REF: LM8281, LM8282



IP:
IP20
BRIGHTNESS:
2400
ANGLE:
120°
MATERIAL:
Aluminium / PC
LIGHT SOURCE:
Smd Led
POWER SUPPLY:
175-265V AC
CRI:
80
DIMMABLE:
Si

REF	W	SIZE	COLOR	°K
LM8281	24	300X300X50H mm	Negro / Black	CCT
LM8282	24	300X300X50H mm	Bianco / White	CCT



Included
Remote control

Circular LED Panel Sensor Light Series



IP:
IP20
BRIGHTNESS:
1800
ANGLE:
120°
MATERIAL:
Aluminium / PC
LIGHT SOURCE:
Epistar
POWER SUPPLY:
170-265V AC
DURABILITY:
30000 Hr
CRI:
80
FINISH:
Blanco / White
DETECTION DISTANCE:
6 m
TIME MIN-MAX:
15 seg-5 min
REGULATION TIME:
Dia / Noche
Angle detección:
110°

REF	W	CUT	SIZE	COLOR	*K
LM5573	18	205 mm	218X43H mm	Blanco / White	6000K
LM5574	18	205 mm	218X43H mm	Blanco / White	4500K



Illuminación Interior / Plafones LED / Plafones LED con Sensor de movimiento - Interior Lighting / LED Ceiling Lights / LED Ceiling Lights with Motion Sensor

Surface Mount Circular Panel Sensor Light Series



IP:
IP20
BRIGHTNESS:
1800
ANGLE:
120°
MATERIAL:
Aluminium / PC
LIGHT SOURCE:
Epistar
POWER SUPPLY:
170-265V AC
DURABILITY:
30000 Hr
CRI:
80
FINISH:
Blanco / White
DETECTION DISTANCE:
6 m
TIME MIN-MAX:
15 seg-5 min
REGULATION TIME:
Dia / Noche
Angle detección:
110°

REF	W	SIZE	COLOR	*K
LM5571	18	222X43H mm	Blanco / White	6000K
LM5572	18	222X43H mm	Blanco / White	4500K



GAMA PANELES LED SENSOR LIGHT

Transforma tu experiencia de iluminación con tecnología inteligente.

Detección Amplia: Ángulo de detección de 110°, los paneles **Sensor Light** capturan un campo amplio.

Alcance 6 m: Iluminación se activa de manera precisa cuando sea necesario, mejorando así la eficiencia energética.

Temporización Personalizada: Ajuste el tiempo de activación, con un rango que va desde **15 seg** hasta **5 min**, ofreciendo flexibilidad en la personalización.

Eficiencia Energética: Los paneles **Sensor Light** optimizan el consumo de energía al proporcionar luz solo cuando es necesario.

Tecnología de Detección Avanzada: Equipados con tecnología de última generación, estos paneles garantizan una respuesta rápida y precisa a los movimientos.

Instalación Sencilla: Diseñados para una instalación fácil y rápida, integración en cualquier espacio.

Versatilidad en Aplicaciones: Estos paneles son ideales para una variedad de aplicaciones, desde pasillos y áreas de trabajo hasta zonas de recepción.

Transform your lighting experience with smart technology.

Wide Detection: With a 110° detection angle, Sensor Light panels capture a broad field.

6m Range: Lighting is activated precisely when needed, thus enhancing energy efficiency.

Customized Timing: Adjust activation time, with a range from 15 seconds to 5 minutes, offering flexibility in customization.

Energy Efficiency: Sensor Light panels optimize energy consumption by providing light only when needed.

Advanced Detection Technology: Equipped with state-of-the-art technology, these panels ensure a quick and accurate response to movements.

Easy Installation: Designed for easy and quick installation, they integrate seamlessly into any space.

Application Versatility: These panels are ideal for a variety of applications, from hallways and work areas to reception areas.

Kram CCT LED Downlight

Protección IP20: Este plafón LED garantiza protección contra el polvo y objetos sólidos, asegurando su rendimiento en entornos interiores.
Intensidad Luminosa de 1500 Lúmenes: El Plafón LED Kram proporciona una iluminación brillante y uniforme, creando un ambiente claro y acogedor.
Ángulo de Iluminación Amplio: Dispersión uniforme de la luz, eliminando zonas oscuras y resaltando cada detalle de tu espacio.
Fuente Luminosa Sanan: Equipado con la avanzada tecnología de la fuente luminosa Sanan, este plafón LED garantiza una iluminación de alta calidad y eficiencia.
Vida Útil Prolongada: Con una vida útil de **30,000 horas**, asegura un rendimiento duradero, reduciendo la necesidad de reemplazos frecuentes.
CRI de 80: Un CRI de 80 asegura una representación precisa y natural de los Colores, proporcionando una iluminación confortable y nítida.
Detección de Movimiento de 360 grados: Detecta movimientos en todas las direcciones, brindando una respuesta rápida y eficiente.
Distancia de Detección de 6 metros: Este plafón LED asegura una detección precisa, activando la iluminación solo cuando es necesario.
Tiempo Ajustable entre 30 segundos y 120 segundos: Con un rango de tiempo ajustable entre **30 segundos y 120 segundos**, el Plafón LED Kram te permite personalizar la duración de la iluminación después de la detección de movimiento, adaptándose a tus necesidades específicas.
Regulación de Tiempo Día/Noche: La función de regulación de tiempo día/noche ajusta automáticamente el tiempo de encendido según la luminosidad ambiente, maximizando la eficiencia energética y brindando una experiencia de iluminación adaptada al entorno.

IP20 Protection: This LED ceiling light ensures protection against dust and solid objects, ensuring its performance in indoor environments.
Luminous Intensity of 1500 Lumens: The **Kram LED Ceiling Light** provides bright and uniform illumination, creating a clear and cozy ambiance.
Wide Illumination angle: Uniform light dispersion, eliminating dark areas and highlighting every detail of your space.
Sanan light source: Equipped with advanced Sanan light source technology, this **LED ceiling light** ensures high-quality and efficient lighting.
Extended Lifespan: With a lifespan of **30,000 hours**, it ensures long-lasting performance, reducing the need for frequent replacements.
CRI of 80: An 80 CRI ensures accurate and natural color representation, providing comfortable and sharp illumination.
360-degree Motion Detection: Detects movements in all directions, providing a quick and efficient response.
6-meter detection distance: This LED ceiling light ensures precise detection, activating the lighting only when necessary.
Adjustable Time between 30 seconds and 120 seconds: With an adjustable time range between **30 seconds and 120 seconds**, the **Kram LED Ceiling Light** allows you to customize the lighting duration after motion detection, adapting to your specific needs.
Day/Night Time Adjustment: The day/night time adjustment function automatically adjusts the turn-on time based on ambient brightness, maximizing energy efficiency and providing a lighting experience tailored to the environment.



Compatible accessories:



LM2128
Kit de Conversion de Emergencia Hasta 20W



IP
IP20
BRIGHTNESS
1500
ANGLE
120°
MATERIAL
CERAMICA/PC
LIGHT SOURCE
SANAN
POWER SUPPLY
110-265V AC
DURABILITY
30000 HR
CRI
80
ANGLE DETECTION
360°
DISTANCE DETECTION
6 m
TIME MIN-MAX
30 SEG - 120 SEG
REGULATION TIME
DAY / NIGHT

REF	W	CUT	SIZE	COLOR	°K
LM8224	18	65mm a 205 mm	230X19H mm	Blanco / White	CCT





IP
IP20

BRIGHTNESS
80 LM/W

ANGLE
120°

MATERIAL
Aluminium / PC

LIGHT SOURCE
EPISTAR

POWER SUPPLY
170-265V AC

DURABILITY
30000 HR

CRI
80

ANGLE DETECTION
360°

DISTANCE DETECTION
6 m

TIME MIN-MAX
10 SEG - 2 MIN

REGULATION TIME
DAY / NIGHT

LED Ceiling Light With Motion Sensor Halls

Compatible accessories:

REF	W	SIZE	COLOR	°K
LM8219	15	240X70H mm	Blanco / White	6000K
LM8220	15	240X70H mm	Blanco / White	4500K
LM8221	20	293X70H mm	Blanco / White	6000K
LM8222	20	293X70H mm	Blanco / White	4500K
LM8223	20	293X70H mm	Blanco / White	3000K



LM2128
Kit de Conversion de Emergencia Hasta 20W

Descubre la perfecta combinación de diseño, eficiencia y tecnología con el Plafón LED Halls. Transforma tus espacios con una iluminación inteligente y adaptativa que se ajusta a tus necesidades.

Protección IP20: Protección eficaz contra el polvo y objetos sólidos, manteniendo un rendimiento óptimo en condiciones interiores.

Ángulo de Iluminación Amplio: Distribución uniforme de la luz, cubriendo áreas extensas y eliminando zonas oscuras.

Vida Útil Prolongada: Con una vida útil de **30,000 hr**, garantiza un rendimiento constante, reduciendo la necesidad de mantenimiento frecuente.

CRI de 80: El CRI de 80 asegura una representación fiel de los Colores, permitiendo una iluminación natural y precisa en cualquier entorno.

Detección de Movimiento de 360 grados: El Plafón LED Halls detecta movimientos en todas direcciones, proporcionando una respuesta rápida y eficiente.

Distancia de Detección de 6 metros: Este plafón LED asegura una detección precisa, activando la iluminación solo cuando es necesario.

Tiempo Ajustable: Con un rango de tiempo ajustable entre **10 segundos y 2 minutos**, el **Plafón LED Halls** te permite personalizar la duración de la iluminación después de la detección de movimiento, adaptándose a tus necesidades específicas.

Regulación de Tiempo Día/Noche: La función de regulación de tiempo día/noche permite ajustar automáticamente el tiempo de encendido en función de la luminosidad ambiente, optimizando así la eficiencia energética.

Discover the perfect combination of design, efficiency, and technology with the LED Halls Ceiling Light. Transform your spaces with intelligent and adaptive lighting that adjusts to your needs.

IP20 Protection: Effective protection against dust and solid objects, maintaining optimal performance in indoor conditions.

Wide Illumination angle: Uniform light distribution, covering extensive areas and eliminating dark zones.

Extended Lifespan: With a lifespan of 30,000 hours, it ensures consistent performance, reducing the need for frequent maintenance.

CRI of 80: An 80 CRI ensures faithful color representation, allowing natural and precise lighting in any environment.

360-degree Motion Detection: The LED Halls Ceiling Light detects motion in all directions, providing a quick and efficient response.

6-meter detection distance: This ceiling light ensures precise detection, activating the lighting only when necessary.

Adjustable Time: With an adjustable time range between 10 seconds and 2 minutes, the LED Halls Ceiling Light allows you to customize the lighting duration after motion detection, adapting to your specific needs.

Day/Night Time Adjustment: The day/night time adjustment function allows for automatic adjustment of turn-on time based on ambient brightness, thereby optimizing energy efficiency.

Motion Sensor Ceiling Light Nantes

Presentamos el Plafón LED Nantes, una innovadora solución de iluminación que combina la eficiencia de la tecnología LED con la inteligencia de un avanzado sensor de movimiento.

Protección IP20: Este plafón LED garantiza protección contra el polvo y objetos sólidos, asegurando su rendimiento en entornos interiores.

Ángulo de Iluminación Amplio: Proporciona una distribución uniforme de la luz, eliminando zonas oscuras y creando un ambiente luminoso y acogedor.

Material Duradero: Fabricado con aluminio y PC de alta calidad, el Plafón LED Nantes combina durabilidad y ligereza, garantizando un producto resistente.

Detección de Movimiento de 360 grados: Este plafón LED detecta movimientos en todas las direcciones, brindando una respuesta rápida y eficiente.

Distancia de Detección de 6 metros: El Plafón LED Nantes asegura una detección precisa, activando la iluminación solo cuando es necesario.

Tiempo Ajustable: Con un rango de tiempo ajustable entre **20 segundos y 40 segundos**, este plafón LED te permite personalizar la duración de la iluminación después de la detección de movimiento, adaptándose a tus necesidades específicas.

Regulación de Tiempo Día/Noche: La función de regulación de tiempo día/noche permite ajustar automáticamente el tiempo de encendido en función de la luminosidad.

Introducing the LED Nantes Flush Mount, an innovative lighting solution that combines the efficiency of LED technology with the intelligence of an advanced motion sensor.

IP20 Protection: This LED flush mount ensures protection against dust and solid objects, ensuring its performance in indoor environments.

Wide Illumination angle: Provides uniform light distribution, eliminating dark areas and creating a bright and welcoming atmosphere.

Durable Material: Manufactured with high-quality aluminum and PC, the LED Nantes Flush Mount combines durability and lightness, guaranteeing a resilient product.

360-degree Motion Detection: This LED flush mount detects movements in all directions, providing a quick and efficient response.

6-meter detection distance: The LED Nantes Flush Mount ensures precise detection, activating the lighting only when necessary.

Adjustable Time: With an adjustable time range between **20 seconds and 40 seconds**, this LED flush mount allows you to customize the lighting duration after motion detection, adapting to your specific needs.

Day/Night Time Regulation: The day/night time regulation function automatically adjusts the lighting time based on brightness.

REF	SIZE	COLOR
LM6608	320X100H mm	Blanco / White



IP
IP20
ANGLE
120°
MATERIAL
Aluminium / PC
LIGHT SOURCE
2XE27
POWER SUPPLY
100-240V AC
ANGLE DETECTION
360°
DISTANCE DETECTION
6 m
TIME MIN-MAX
20 SEG - 40 SEG
REGULATION TIME
DAY / NIGHT



IP
IP20
BRIGHTNESS
110 LM/W
ANGLE
60°
MATERIAL
ALUMINIO
LIGHT SOURCE
OSRAM
POWER SUPPLY
220-240V AC
DURABILITY
30000 HR
CRI
80
DRIVER
LIFUD
UGR
17
KV
4KV

REF	W	CUT	SIZE	COLOR	°K
LM4251	30	165 mm	205X85H mm	Blanco / White	6000K
LM4252	30	165 mm	205X85H mm	Blanco / White	4500K
LM4253	30	165 mm	205X85H mm	Blanco / White	3000K
LM4254	50	190 mm	230X95H mm	Blanco / White	6000K
LM4255	50	190 mm	230X95H mm	Blanco / White	4500K
LM4256	50	190 mm	230X95H mm	Blanco / White	3000K



Compatible accessories:



LM2108
Driver Lifud Salida
25-42V Dc 30W
LF-GIR030YM750H



LF-GSD030PF
Driver Lifud Regulable
Dali Salida 20-42V Dc
30W No Flicker



LF-GDE030YG
Driver Lifud Regulable
Triac Salida 25-42V Dc
30W No Flicker



LF-GDE030YF
Driver Lifud Regulable
1-10V Salida 27-40V
Dc 30W



LF-GSP012YG
Kit de Conversion de
Emergencia Hasta 50W



LM2129
Kit de Conversion de
Emergencia 20-50W



Bless LED Downlight Spotlight

Este innovador foco está diseñado para proporcionar una iluminación de calidad en una variedad de entornos, desde espacios comerciales hasta áreas residenciales, destacando por sus características técnicas avanzadas.

Eficiencia Lumínica Imparable: Eficiencia de **110 lm/w**, iluminación potente y a la vez eficiente, maximizando la salida de luz y minimizando el consumo energético.

Ángulo de Iluminación Amplio: Ángulo de iluminación de **60°**, proporcionando una dispersión equitativa de la luz y resaltando eficazmente áreas específicas.

Construcción de Aluminio Duradero: Fabricado con aluminio de alta calidad, no solo ofrece un diseño atractivo, sino también resistencia y durabilidad.

Vida Útil de 30,000 Horas: Iluminación constante y fiable a lo largo del tiempo, reduciendo la necesidad de reemplazos frecuentes.

Índice de Reproducción Cromática (CRI) de 80: Reproducción precisa de los colores y creando ambientes iluminados de manera vívida y natural.

Driver Lífud de Alta Calidad: Estabilidad y eficiencia energética óptimas. Este componente de alta calidad contribuye al rendimiento fiable y constante.

Baja Emisión de Deslumbramiento (UGR 17): Iluminación cómoda y sin molestias visuales, ideal para espacios donde se requiere un ambiente agradable.

Protección IP20: Adecuado para instalaciones en interiores, ofreciendo protección contra objetos sólidos de tamaño superior a **12.5 mm**.

Resistencia a Sobretensiones de 4 kV: Diseñado para resistir sobretensiones de hasta **4 kV**, garantizando la protección del foco ante posibles picos de voltaje.

This innovative spotlight is designed to provide quality lighting in a variety of environments, from commercial spaces to residential areas, standing out for its advanced technical features.

Unrivaled Luminous Efficiency: With an efficiency of **110 lm/w**, it offers powerful yet efficient illumination, maximizing light output while minimizing energy consumption.

Wide Illumination angle: With a **60°** illumination angle, it provides even light dispersion and effectively highlights specific areas.

Durable Aluminum Construction: Made with high-quality aluminum, it not only offers an attractive design but also resilience and durability.

30,000 Hour Lifespan: Provides consistent and reliable lighting over time, reducing the need for frequent replacements.

Color Rendering Index (CRI) of 80: Accurate color reproduction, creating vivid and natural illuminated environments.

High-Quality Lífud DRIVER: Optimal stability and energy efficiency. This high-quality component contributes to reliable and consistent performance.

Low Glare Emission (UGR 17): Comfortable and glare-free lighting, ideal for spaces where a pleasant ambiance is required.

IP20 Protection: Suitable for indoor installations, offering protection against solid objects larger than **12.5 mm** in size.

4 kV Surge Protection: Designed to withstand surges of up to **4 kV**, ensuring the spotlight's protection against potential voltage spikes.

Downlight Led Luxtar



IP:
IP20
BRIGHTNESS:
110 LM/W
ANGLE:
90°
MATERIAL:
Aluminio
LIGHT SOURCE:
Sanan
POWER SUPPLY:
220-240V ADC
DURABILITY:
30000 Hr
CRI:
80
UGR:
19
FINISH:
Opal

REF	W	CUT	SIZE	COLOR	*K
GA4260	15	100 mm	115X50H mm	Blanco / White	6000K
GA4261	15	100 mm	115X50H mm	Blanco / White	4500K
GA4266	15	100 mm	115X50H mm	Blanco / White	3000K
GA4262	30	145 mm	160X55H mm	Blanco / White	6000K
GA4263	30	145 mm	160X55H mm	Blanco / White	4500K
GA4267	30	145 mm	160X55H mm	Blanco / White	3000K
GA4264	50	200 mm	215X65H mm	Blanco / White	6000K
GA4265	50	200 mm	215X65H mm	Blanco / White	4500K
GA4268	50	200 mm	215X65H mm	Blanco / White	3000K



Compatible accessories:



LM2128
Kit de Conversion de Emergencia Hasta 20W

Downlight Led Lass



IP:
IP40
BRIGHTNESS:
3200
ANGLE:
120°
MATERIAL:
Aluminio
LIGHT SOURCE:
Bridgelux
POWER SUPPLY:
85-265V AC
DURABILITY:
30000 Hr
CRI:
80

REF	W	CUT	SIZE	COLOR	*K
LM5353	32	180 mm	220X30H mm	Blanco / White	6000K
LM5354	32	180 mm	220X30H mm	Blanco / White	4500K
LM5355	32	180 mm	220X30H mm	Blanco / White	3000K



Compatible accessories:



LM2108
Driver Lifud Salida 25-42V Dc 30W
LF-Gir030Ym750H



LF-GSD030PF
Driver Lifud Regulable Dali Salida 20-42V Dc 30W No Flicker



LF-GDE030YG
Driver Lifud Regulable Triac Salida 25-42V Dc 30W No Flicker



LF-GDE030YF
Driver Lifud Regulable 1-10V Salida 27-40V Dc 30W



LF-GSP012YG
Kit de Conversion de Emergencia Hasta 50W



LM2129
Kit de Conversion de Emergencia 20-50W

Downlight Led Pro Lass



IP:
IP20
BRIGHTNESS:
5000
ANGLE:
120°
MATERIAL:
Aluminio
LIGHT SOURCE:
Sanan
POWER SUPPLY:
85-265V AC
DURABILITY:
30000 Hr
CRI:
80

REF	W	CUT	SIZE	COLOR	*K
GA5356	50	185 mm	225X40H mm	Blanco / White	6000K
GA5357	50	185 mm	225X40H mm	Blanco / White	4500K



Downlight Led Pro Lass 22W



REF	W	CUT	SIZE	COLOR	°K
GA5293	22	180 mm	220X30H mm	Blanco / White	6000K
GA5294	22	180 mm	220X30H mm	Blanco / White	4500K
GA5295	22	180 mm	220X30H mm	Blanco / White	3000K

The brightest choice for your spaces

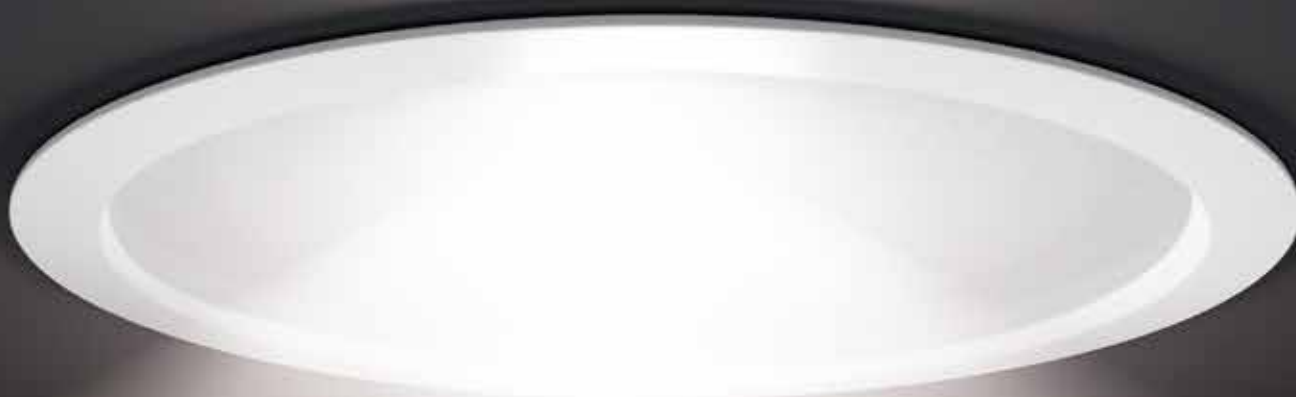

IP

IP20

BRIGHTNESS

2200

ANGLE

120°

MATERIAL

ALUMINIO

LIGHT SOURCE

LUMILEDS

POWER SUPPLY

220-240V AC

DURABILITY

30000 HR

CRI

80

DRIVER

LIFUD

UGR

19

POWER FACTOR

0.6

Circular LED Downlight

Serie Advance CCT



Includes
Swift CCT

REF	W	CUT	SIZE	COLOR	°K
LM5001	9	90 mm	120X2,6H mm	Blanco / White	CCT
LM5004	12	120 mm	135X2,6H mm	Blanco / White	CCT
LM5003	18	140 mm	160X2,6H mm	Blanco / White	CCT
LM5005	24	190 mm	220X2,6H mm	Blanco / White	CCT

Compatible accessories:



LM0051
Aro de Superficie Para
Downlight Led Advance
9W



LM0052
Aro de Superficie Para
Downlight Led Advance
12W



LM0053
Aro de Superficie Para
Downlight Led Advance
18W

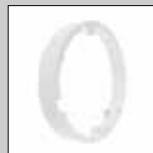

LM0054
Aro de Superficie Para
Downlight Led Advance
24W

Step into a bright future with the Advance CCT series

IP
IP20

BRIGHTNESS
100 LM/W

ANGLE
120°

MATERIAL
PC

LIGHT SOURCE
SANAN

POWER SUPPLY
170-265V AC

DURABILITY
30000 HR

CRI
80

IK
5

LED Downlight Spotlight Cobmon 7W



REF	W	CUT	SIZE	COLOR	°K
LM4171	7	75 mm	82X45H mm	Blanco / White	6000 K
LM4172	7	75 mm	82X45H mm	Blanco / White	4500 K
LM4173	7	75 mm	82X45H mm	Blanco / White	3000 K



Step into a bright future with the Advance CCT series

IP

IP20

BRIGHTNESS

560

ANGLE

24°

MATERIAL

ALUMINIO

LIGHT SOURCE

EPISTAR

POWER SUPPLY

170-265V AC

DURABILITY

30000 HR

CRI

90

POWER FACTOR

0.6

Adjustable LED Downlight Spotlight



REF	W	CUT	SIZE	COLOR	°K
LM4161	7	65 mm	90X50H mm	Blanco / White	6000 K
LM4162	7	65 mm	90X50H mm	Blanco / White	4500 K
LM4163	7	65 mm	90X50H mm	Blanco / White	3000 K



Maximum brightness, minimum consumption.

IP

IP20

BRIGHTNESS

560

ANGLE

36°

MATERIAL

PC

LIGHT SOURCE

BRIDGELUX

POWER SUPPLY

85-265V AC

DURABILITY

30000 HR

CRI

80

IK

5

LED Downlight Spotlight



REF	W	CUT	SIZE	COLOR	°K
GA4404	10	75 mm	85X50H mm	Blanco / White	6000 K
GA4405	10	75 mm	85X50H mm	Blanco / White	4500 K
GA4406	10	75 mm	85X50H mm	Blanco / White	3000 K
GA4407	15	90 mm	105X53H mm	Blanco / White	6000 K
GA4408	15	90 mm	105X53H mm	Blanco / White	4500 K
GA4409	15	90 mm	105X53H mm	Blanco / White	3000 K
GA4410	20	115 mm	135X53H mm	Blanco / White	6000 K
GA4411	20	115 mm	135X53H mm	Blanco / White	4500 K
GA4412	20	115 mm	135X53H mm	Blanco / White	3000 K



More than light, a luminous experience.

IP

IP20

BRIGHTNESS

90 LM/W

ANGLE

36°

MATERIAL

ALUMINIO

LIGHT SOURCE

EPISTAR

POWER SUPPLY

170-265V AC

DURABILITY

30000 HR

CRI

90

POWER FACTOR

0.6

Downlight Led Didle 3W



REF	W	CUT	SIZE	COLOR	°K
LM4228	3	30 mm	40X25H mm	Blanco / White	6000 K
LM4230	3	30 mm	40X25H mm	Blanco / White	3000 K



The best lighting in the palm of your hand

IP
IP20

BRIGHTNESS

350

ANGLE

24°

MATERIAL

Aluminium / PC

LIGHT SOURCE

COB

POWER SUPPLY

85-265V AC

DURABILITY

30000 HR

CRI

80

POWER FACTOR

0.5

LED Downlight Spotlight

Deep 5W CCT

IP
IP20
BRIGHTNESS
420
ANGLE
24°
MATERIAL
Aluminium / PC
LIGHT SOURCE
COB
POWER SUPPLY
85-265V AC
DURABILITY
30000 HR
CRI
80
POWER FACTOR
0.5



REF	W	CUT	SIZE	COLOR	*K
LM4311	5	30 mm	40X25H mm	Negro / Black	CCT
LM4312	5	30 mm	40X25H mm	Blanco / White	CCT



LED Downlight Spotlight Road 7W IP54



REF	W	CUT	SIZE	COLOR	°K
LM4281	7	72 mm	85X40H mm	Blanco / White	6000 K
LM4282	7	72 mm	85X40H mm	Blanco / White	4500 K
LM4283	7	72 mm	85X40H mm	Blanco / White	3000 K



Road LED, where light finds its destination.

IP
IP20

BRIGHTNESS
500

ANGLE
36°

MATERIAL
Aluminium / PC

LIGHT SOURCE
SMD LED

POWER SUPPLY
220-240V AC

DURABILITY
30000 HR

CRI
80

LED Panel Serie Bure 60X60 No Flicker Driver Philips



IP:
IP40
BRIGHTNESS:
4200
ANGLE:
120°
MATERIAL:
Aluminio
LIGHT SOURCE:
Sanan
DRIVER:
Philips
POWER SUPPLY:
170-265V AC
DURABILITY:
30000 Hr
CRI:
80
UGR:
<19

REF	W	SIZE	COLOR	°K
LM5381	42	595X595X35H mm	Blanco / White	6000K
LM5382	42	595X595X35H mm	Blanco / White	4000K
LM5383	42	595X595X35H mm	Blanco / White	3000K



Compatible accessories:



LM9031
Colgadores Para Paneles Led 3M



LM2109
Driver Lifud Salida 25-42V Dc 40W Lf-Gir040Ym1000H



LM9033
Grapas Para Paneles Led



LM9032
Kit de Superficie de Panel 60X60 Blanco 65 Mm



LF-GSD040PF
Driver Lifud Regulable Dali Salida 20-42V Dc 40W No Flicker



LF-GSP012YG
Kit de Conversion de Emergencia Hasta 50W



LM2520
Driver Lifud Regulable 0-10V Salida 20-42V Dc



LM2284
Driver Philips Certadrive 220-240V Salida 32-42V 1050Ma 44W



LM2129
Kit de Conversion de Emergencia 20-50W

LED Panel Serie Trielle 60X60 No Flicker



IP:
IP40
BRIGHTNESS:
100 LM/W
ANGLE:
120°
MATERIAL:
Aluminio
LIGHT SOURCE:
Epistar
POWER SUPPLY:
170-265V AC
DURABILITY:
30000 Hr
CRI:
80

REF	W	UGR	SIZE	COLOR	°K
LM5305	48	17	595X595X35H mm	Blanco / White	6000K
LM5306	48	17	595X595X35H mm	Blanco / White	4500K
LM5307	48	17	595X595X35H mm	Blanco / White	6000K
LM5314	42	19	595X595X35H mm	Blanco / White	6000K
LM5315	42	19	595X595X35H mm	Blanco / White	4500K
LM5317	60	19	595X595X35H mm	Blanco / White	6000K
LM5318	60	19	595X595X35H mm	Blanco / White	4500K



Compatible accessories:



LM9031
Colgadores Para Paneles Led 3M



LM2109
Driver Lifud Salida 25-42V Dc 40W Lf-Gir040Ym1000H



LM9033
Grapas Para Paneles Led



LM9032
Kit de Superficie de Panel 60X60 Blanco 65 Mm



LF-GSD040PF
Driver Lifud Regulable Dali Salida 20-42V Dc 40W No Flicker



LF-GSP012YG
Kit de Conversion de Emergencia Hasta 50W



LM2520
Driver Lifud Regulable 0-10V Salida 20-42V Dc



LM2284
Driver Philips Certadrive 220-240V Salida 32-42V 1050Ma 44W



LM2129
Kit de Conversion de Emergencia 20-50W

Rectangular LED Panel Bure Series 120X30

REF	W	BRIGHTNESS	SIZE	COLOR	*K
LM5267	40	4000	1195X295X30H mm	Blanco / White	CCT

Lifud/Opcional regulable 1-10V
LM2520



Opcional regulable Dali
Lf-GSD040PF

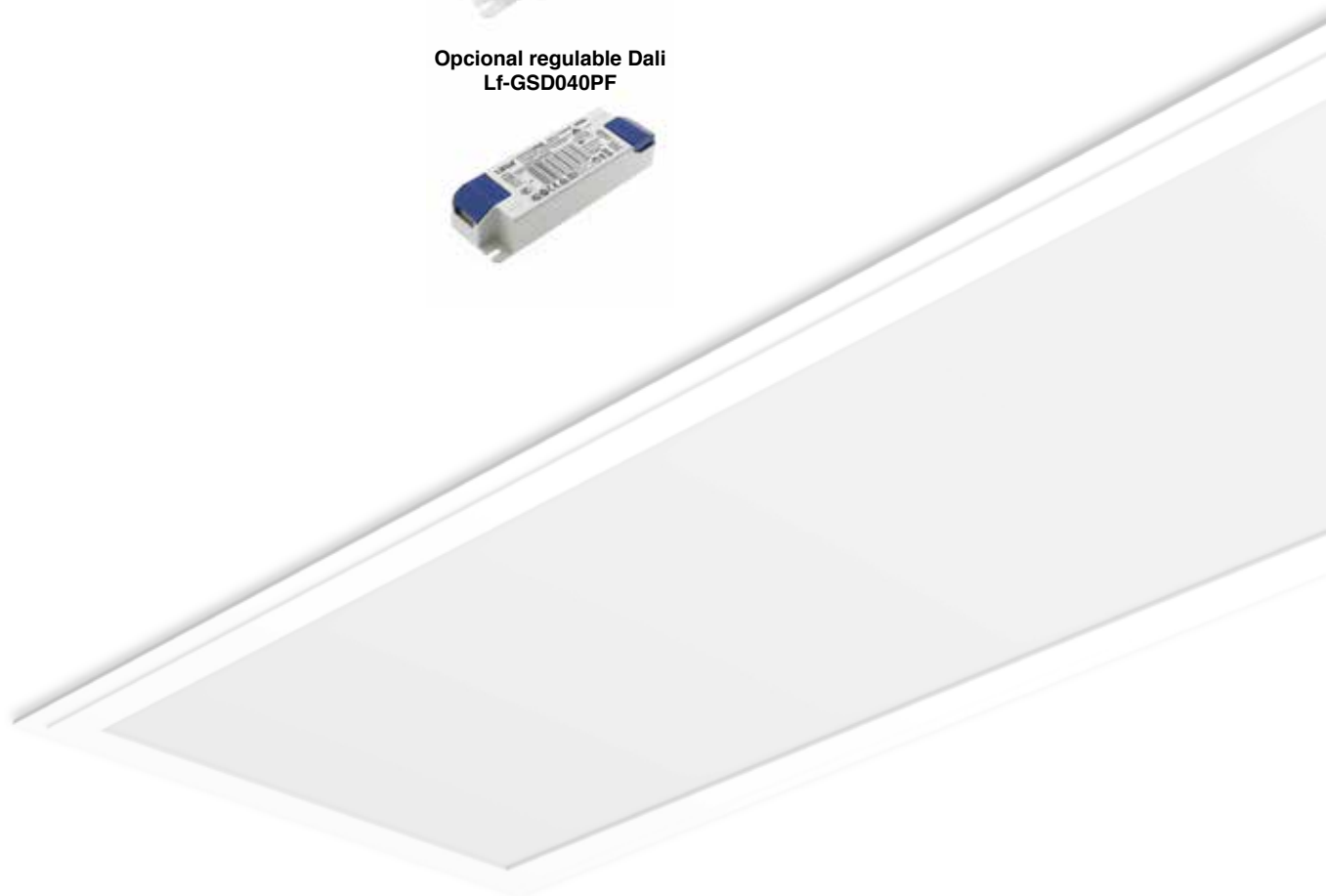

Compatible accessories:



LM9031
Kit de Superficie de
Panel 120X30 Blanco
65 Mm



LM9033
Grapas Para Paneles
Led



LM2520
Driver Lifud Regulable
0-10V Salida 20-42V Dc
Lf-Aaa040B1050-42



LM2284
Driver Philips Certadriver
220-240V Salida 32-42V
1050Ma 44W

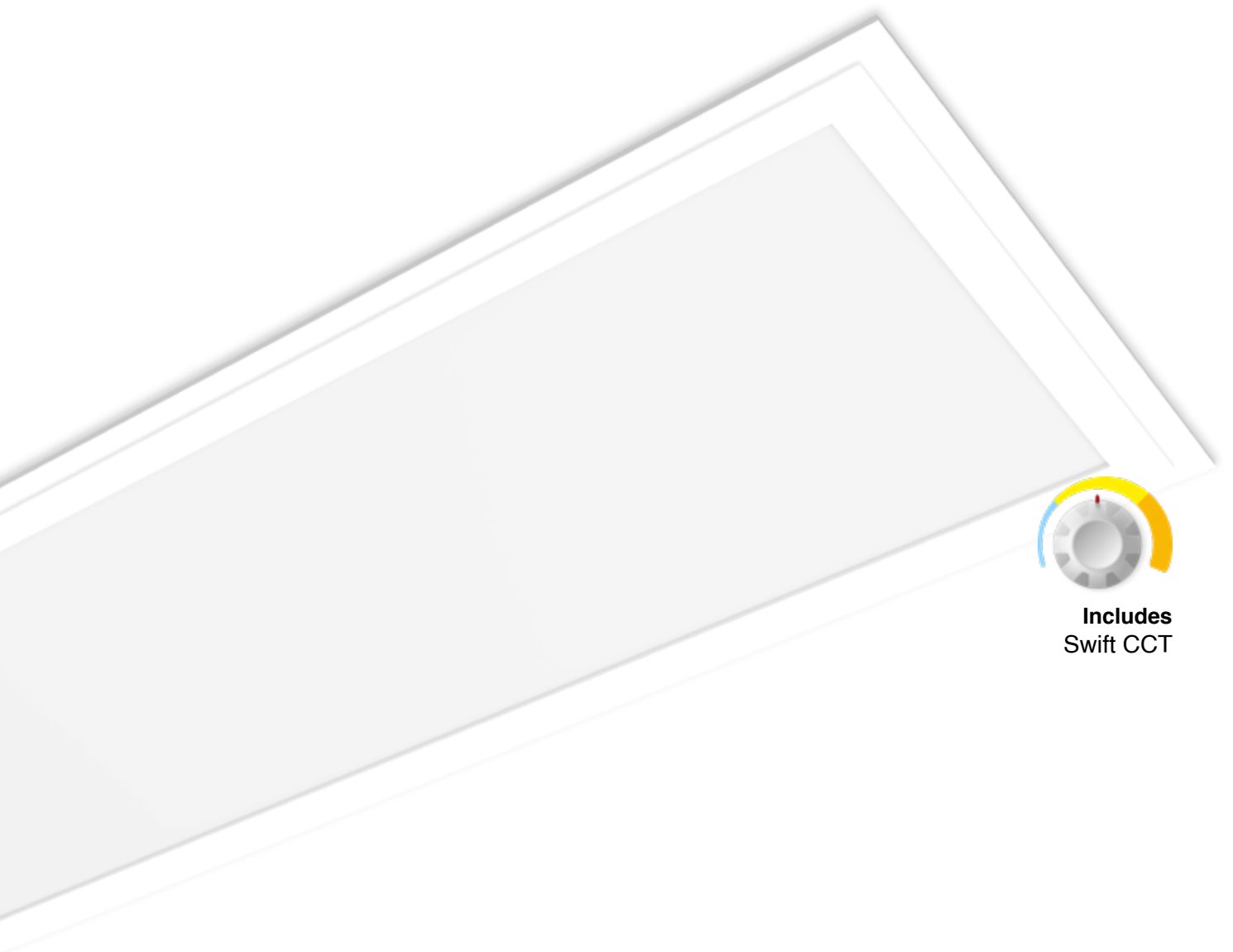

**Includes
Swift CCT**

IP
IP40
BRIGHTNESS
4000LM
ANGLE
120°
MATERIAL
Aluminium
LIGHT SOURCE
Sanan
POWER SUPPLY
170-265V AC
DURABILITY
30000 HR
CRI
80
UGR
19
POWER FACTOR
0.9
TEMP WORK
-20°C ~ + 45°C



LED Panel Rectangular Serie Bure



IP:
IP40
ANGLE:
120°
MATERIAL:
Aluminio
LIGHT SOURCE:
Smd 2835
POWER SUPPLY:
170-265V AC
DURABILITY:
30000 Hr
CRI:
80
UGR:
19

REF	W	BRIGHTNESS	SIZE	COLOR	°K
LM5321	24	2400	592X295X23H mm	Blanco / White	6000K
LM5322	24	2400	592X295X23H mm	Blanco / White	4000K
LM5268	80	6500	1195X595X30H mm	Blanco / White	6000K
LM5269	80	6500	1195X595X30H mm	Blanco / White	4000K



Compatible accessories:



LM9031
Colgadores Para Paneles Led 3M



LM9033
Grapas Para Paneles Led

LED Panel de Marco Luminoso 42W No Flicker

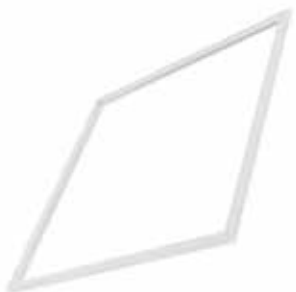

IP:
IP20
BRIGHTNESS:
4200
ANGLE:
120°
MATERIAL:
Aluminio
LIGHT SOURCE:
Epistar
DRIVER:
Lifud
POWER SUPPLY:
170-265V AC
DURABILITY:
30000 Hr
CRI:
80

REF	W	SIZE	COLOR	°K
LM5329	42	590X590X26H mm	Blanco / White	6000K
LM5330	42	590X590X26H mm	Blanco / White	4500K



Compatible accessories:



LM2109
Driver Lifud Salida 25-42V Dc 40W Lf-Gir040Ym1000H



LF-GSD040PF
Driver Lifud Regulable Dali Salida 20-42V Dc 40W No Flicker



LF-GSP012YG
Kit de Conversion de Emergencia Hasta 50W



LM2520
Driver Lifud Regulable 0-10V Salida 20-42V Dc



LM2129
Kit de Conversion de Emergencia 20-50W

T8 Ekran LED Tube One-Side Connection



IP:
IP42
BRIGHTNESS:
100 LM/W
ANGLE:
120°
MATERIAL:
Aluminio
LIGHT SOURCE:
Smd 2835
POWER SUPPLY:
85-265V AC
DURABILITY:
30000 Hr
CRI:
80

REF	W	SIZE	COLOR	°K
LM1001	10	600X30 mm	Opal	6000K
LM1010	20	1200X30 mm	Opal	6000K
LM1012	20	1200X30 mm	Opal	4500K
LM1016	24	1500X30 mm	Opal	6000K
LM1018	24	1500X30 mm	Opal	4500K
LM1053	20	1200X30 mm	Opal	Verde
LM1054	20	1200X30 mm	Opal	Azul
LM1055	20	1500X30 mm	Opal	Rosa



Compatible accessories:



LM1021
Soporte Para Tubo Led
600 Mm Zaston
Conexión un Lado



LM2128
Kit de Conversion de
Emergencia Hasta 20W



LM1026
Pantalla Estanca Para
un Tubo Led Platno
1200 Mm



LM1028
Pantalla Estanca Para
dos Tubos Led Platno
1200 Mm

T8 Ekran LED Tube Two-Side Connection



IP:
IP20
BRIGHTNESS:
100 LM/W
ANGLE:
300°
MATERIAL:
Cristal
LIGHT SOURCE:
Smd 2835
POWER SUPPLY:
170-265V AC
DURABILITY:
30000 Hr
CRI:
80

REF	W	SIZE	COLOR	°K
LM1056	9	600X30 mm	Opal	6000K
LM1059	9	600X30 mm	Opal	4500K
LM1057	18	1200X30 mm	Opal	6000K
LM1063	18	1200X30 mm	Opal	4500K
LM1058	24	1500X30 mm	Opal	6000K
LM1064	24	1500X30 mm	Opal	4500K
LM1068	12	900X30 mm	Opal	6000K



Compatible accessories:



LM1021
Soporte Para Tubo Led
600 Mm Zaston
Conexión un Lado



LM2128
Kit de Conversion de
Emergencia Hasta 20W



LM1026
Pantalla Estanca Para
un Tubo Led Platno
1200 Mm



LM1028
Pantalla Estanca Para
dos Tubos Led Platno
1200 Mm



Includes
Starter

LED Fixture Slimline Fast



IP:
IP20
BRIGHTNESS:
4000
ANGLE:
120°
MATERIAL:
Aluminio/ABS
LIGHT SOURCE:
Sanam
POWER SUPPLY:
170-265V AC
DURABILITY:
50000 Hr
CRI:
85

REF	W	SIZE	COLOR	°K
LM1170	40	1200X75X30H mm	Blanco / White	6000K
LM1171	40	1200X75X30H mm	Blanco / White	4500K



Includes
Staples

T8 1200MM EKTRAN LED TUBE WITH MOTION SENSOR SAFETY CONNECTION ON TWO SIDES

IP
IP42

BRIGHTNESS
2400

ANGLE
120°

MATERIAL
ALUMINIO

LIGHT SOURCE
SMD 2835

POWER SUPPLY
85-265V AC

DURABILITY
30000 HR

CRI
80

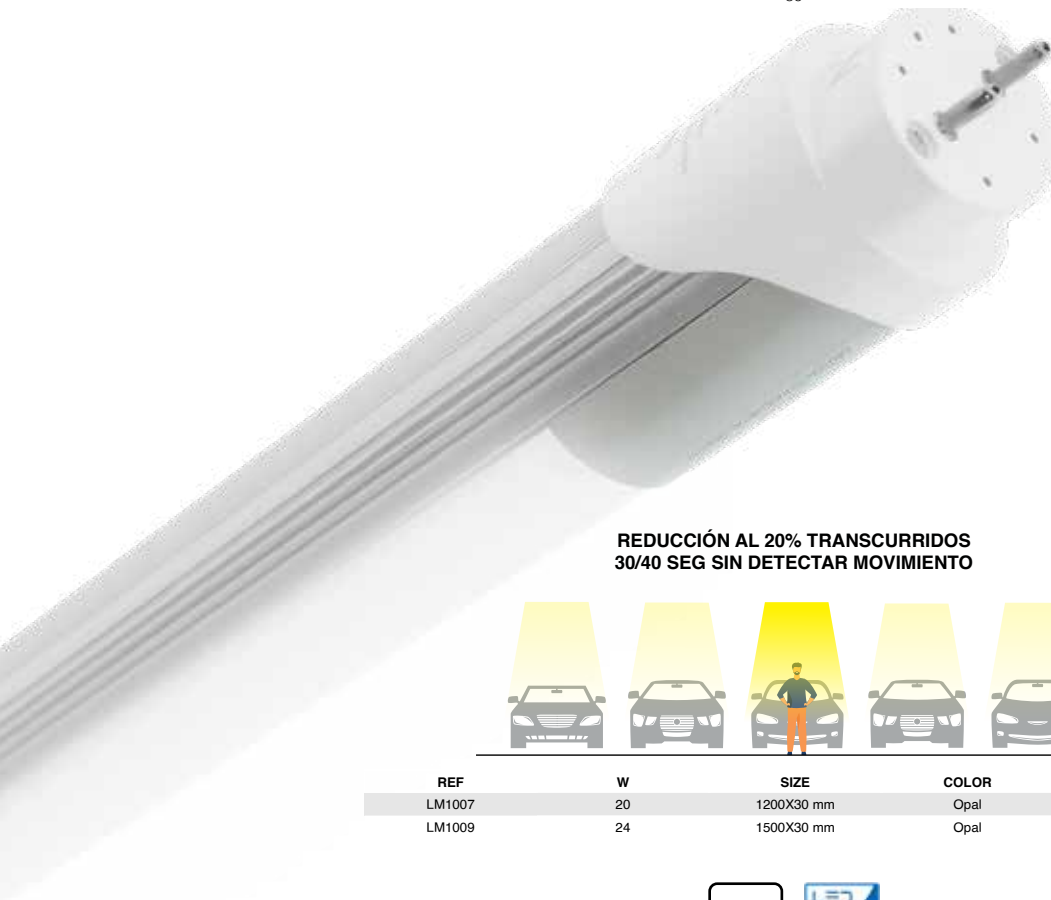

**REDUCCIÓN AL 20% TRANSCURRIDOS
30/40 SEG SIN DETECTAR MOVIMIENTO**

REF	W	SIZE	COLOR	°K
LM1007	20	1200X30 mm	Opal	6000K
LM1009	24	1500X30 mm	Opal	6000K



Fuente Lumínica SMD 2835: Este tubo LED garantiza una fuente lumínica de alta calidad, ofreciendo una iluminación brillante y uniforme.

Luminosidad Potente: Con **2000 lúmenes**, este tubo LED proporciona una iluminación brillante, ideal para diversos entornos.

Ángulo de Iluminación Amplio: Un ángulo de iluminación de **120°** asegura una distribución uniforme de la luz, cubriendo áreas extensas con claridad y precisión.

Vida Útil Prolongada: Vida útil de **30,000 horas**, asegurando una durabilidad a largo plazo y reduciendo la necesidad de reemplazos frecuentes.

Protección IP42: Protegido contra el polvo y salpicaduras, garantizando un rendimiento constante incluso en condiciones desafiantes.

Área de Detección < 10 metros: Sensor de movimiento detecta movimientos en un radio de menos de **10 metros**, proporcionando una respuesta rápida y precisa.

Duración de Encendido Ajustable: La luz se mantiene encendida durante **1 min** después de detectar movimiento, ofreciendo iluminación temporal en áreas activas.

Ángulo de Detección de 180 grados: Con un amplio ángulo de detección, el Tubo LED Ekran abarca una gran área, asegurando una detección efectiva.

Reducción de Intensidad Automática: La intensidad lumínica se reduce al **20%** después de **30/40 seg** sin detectar movimiento, mejorando la eficiencia energética.

SMD 2835 light source: This LED tube ensures a high-quality light source, offering bright and uniform illumination.

Powerful brightness: With **2000 lumens**, this LED tube provides bright lighting, ideal for various environments.

Wide illumination angle: A **120°** illumination angle ensures uniform light distribution, covering extensive areas with clarity and precision.

Extended Lifespan: A lifespan of **30,000 hours** ensures long-term durability and reduces the need for frequent replacements.

IP42 Protection: Protected against dust and splashes, ensuring consistent performance even in challenging conditions.

Detection Area < 10 meters: The motion sensor detects movements within a radius of less than **10 meters**, providing a quick and accurate response.

Adjustable On Time: The light remains on for **1 minute** after motion detection, offering temporary lighting in active areas.

180-degree detection angle: With a wide detection angle, the Ekran LED Tube covers a large area, ensuring effective detection.

Automatic Dimming: Light intensity is reduced to **20%** after **30/40 seconds** without motion detection, improving energy efficiency.

LED Fixture Slimline Moments



IP:
IP20
BRIGHTNESS:
90 LM/W
ANGLE:
120°
MATERIAL:
Aluminio/ABS
LIGHT SOURCE:
Sanan
POWER SUPPLY:
165-265V AC
DURABILITY:
30000 Hr
CRI:
80

REF	W	SIZE	COLOR	°K
LM1190	40	600X100X16H mm	Blanco / White	6000K
LM1191	40	600X100X16H mm	Blanco / White	4500K
LM1181	90	1200X100X16H mm	Blanco / White	6000K
LM1182	90	1200X100X16H mm	Blanco / White	4500K
LM1194	110	1500X100X16H mm	Blanco / White	6000K



Includes
Staples

LED Fixture Slimline Garaz



IP:
IP65
BRIGHTNESS:
80 LM/W
ANGLE:
120°
MATERIAL:
Aluminio/ABS
LIGHT SOURCE:
Sanan
POWER SUPPLY:
85-265V AC
DURABILITY:
30000 Hr
CRI:
85

REF	W	SIZE	COLOR	°K
LM1075	25	620X62X55H mm	Gris / Grey	6000K
LM1078	50	1185X62X55H mm	Gris / Grey	6000K
LM1079	60	1525X62X55H mm	Blanco / White	6000K



Includes
Staples

Linkable CCT Proline 600mm LED Waterproof Fixture



IP:
IP65
BRIGHTNESS:
105 LM/W
ANGLE:
120°
MATERIAL:
PC
LIGHT SOURCE:
Lumileds
DRIVER:
Lifud
POWER SUPPLY:
170-265V AC
DURABILITY:
50000 Hr
CRI:
80

REF	W	SIZE	COLOR	°K
LM1105	18	600X85X75H mm	Gris / Grey	CCT
LM1106	40	1200X85X75H mm	Gris / Grey	CCT
LM1107	50	1500X85X75H mm	Gris / Grey	CCT



Includes
Swift CCT

Compatible accessories:



LF-GSD030PF
Driver Lifud Regulable
Dali Salida 20-42V Dc
30W No Flicker



LF-GSD040PF
Driver Lifud Regulable
Dali Salida 20-42V Dc
40W No Flicker



LM2520
Driver Lifud Regulable
0-10V Salida 20-42V Dc
Lf-Aaa040B1050-42



LM2129
Kit de Conversion de
Emergencia 20-50W



IP
IP65
LIGHT SOURCE
TUBO T8
MATERIAL
PC

REF	SIZE	UND
LM1028	1200X110X90 mm	Two tubes
LM1029	1565X110X90 mm	Two tubes
LM1026	1200X66X90 mm	Tube
LM1027	1565X66X90 mm	Tube



WATERPROOF FIXTURE FOR TWO PLATNO LED TUBES

Descubre Platno, nuestra innovadora Pantalla Estanca diseñada para alojar dos tubos LED T8, proporcionando una iluminación eficiente y duradera en entornos que requieren protección contra agentes externos. Esta pantalla se destaca por sus características técnicas avanzadas y su construcción robusta, asegurando un rendimiento confiable en cualquier aplicación.

Fuente Lumínica de Alta Eficiencia: Platno está diseñada para utilizar tubos LED T8, ofreciendo una fuente lumínica eficiente y de alto rendimiento. Los tubos LED T8 son conocidos por su durabilidad y eficiencia energética, asegurando una iluminación potente y sostenible.

Protección IP65: Con una clasificación de protección IP65, Platno está totalmente sellada contra polvo y resistente al agua. Esta característica la convierte en la elección perfecta para entornos exteriores o instalaciones donde la protección contra elementos externos es fundamental.

Material Resistente de Policarbonato (PC): La estructura de Platno está fabricada con material de policarbonato (PC), conocido por su resistencia y durabilidad. Este material asegura la integridad de la pantalla en condiciones adversas, proporcionando una solución robusta y de larga duración.

Diseño para Dos Tubos LED T8: Platno ha sido diseñada específicamente para albergar dos tubos LED T8, maximizando la eficiencia lumínica y asegurando una distribución uniforme de la luz en el espacio iluminado.

Instalación Sencilla: La Pantalla Estanca Platno se instala de manera sencilla y eficiente, ofreciendo comodidad durante el proceso de montaje. Además, su diseño modular facilita la integración en diferentes entornos y configuraciones.

Discover Platno, our innovative Weatherproof Fixture designed to accommodate two T8 LED tubes, providing efficient and durable lighting in environments requiring protection against external agents. This fixture stands out for its advanced technical features and robust construction, ensuring reliable performance in any application.

High-Efficiency light source: Platno is designed to use T8 LED tubes, offering an efficient and high-performance light source. T8 LED tubes are known for their durability and energy efficiency, ensuring powerful and sustainable illumination.

IP65 Protection: With an IP65 protection rating, Platno is fully sealed against dust and water-resistant. This feature makes it the perfect choice for outdoor environments or installations where protection against external elements is essential.

Durable Polycarbonate (PC) MATERIAL: Platno's structure is made of polycarbonate (PC) material, known for its strength and durability. This material ensures the integrity of the fixture in adverse conditions, providing a robust and long-lasting solution.

Designed for Two T8 LED Tubes: Platno is specifically designed to accommodate two T8 LED tubes, maximizing light efficiency and ensuring uniform light distribution in the illuminated space.

Easy Installation: The Platno Weatherproof Fixture installs quickly and efficiently, offering convenience during the mounting process. Additionally, its modular design makes integration into different environments and configurations straightforward.

IP
IP20

BRIGHTNESS
100 LM/W

ANGLE
120°

MATERIAL
ALUMINIO/ABS

LIGHT SOURCE
LUMILEDS

POWER SUPPLY
85-265V AC

DURABILITY
30000 HR

CRI
80

REF	W	SIZE	COLOR	*K
LM1175	40	1200X55X45H mm	Blanco / White	6000K
LM1176	40	1200X55X45H mm	Blanco / White	4500K
LM1180	80	2400X55X45H mm	Blanco / White	4500K



Compatible accessories:



KB1175
Cable Para Barra Lineal
Trian

LINEAR BAR TRIAN

La Barra Lineal Trian es ideal para una amplia variedad de entornos, desde espacios comerciales hasta áreas residenciales.

Fuente Lumínica de Alta Calidad: Equipada con chips **Lumileds** de última generación, esta luminaria garantiza una fuente lumínica confiable y duradera, ofreciendo una luminosidad de **100 lm/w** para una iluminación clara y nítida.

Ángulo de Iluminación Amplio: Con un ángulo de iluminación de **120°**, proporciona una distribución uniforme de la luz, iluminando de manera efectiva áreas extensas.

Vida Útil Prolongada: Diseñada para resistir el paso del tiempo, esta luminaria cuenta con una vida útil de **30,000 horas**, asegurando una larga duración.

Protección IP20: La Barra Lineal Trian cuenta con una clasificación de protección **IP20**, lo que la hace adecuada para instalaciones en interiores.

Amplio Rango de Alimentación: Con una alimentación compatible de **85-265V AC**, esta luminaria es versátil y puede adaptarse a diferentes condiciones de **voltaje**.

Construcción Duradera: Fabricada en **aluminio y ABS**, ofrece durabilidad y resistencia, asegurando un rendimiento constante.

Índice de Reproducción Cromática (CRI) de 80: Esta luminaria garantiza la reproducción precisa de los colores, creando ambientes iluminados de manera vívida y natural.

The Trian Linear Bar is ideal for a wide variety of environments, from commercial spaces to residential areas.

High-Quality light source: Equipped with state-of-the-art Lumileds chips, this luminaire ensures a reliable and durable light source, offering a brightness of **100 lm/w** for clear and crisp illumination.

Wide Illumination angle: With a **120°** illumination angle, it provides uniform light distribution, effectively illuminating extensive areas.

Extended Lifespan: Designed to withstand the test of time, this luminaire has a lifespan of **30,000 hours**, ensuring long-lasting performance.

IP20 Protection: The Trian Linear Bar has an **IP20** protection rating, making it suitable for indoor installations.

Wide Power Range: With a compatible power input of **85-265V AC**, this luminaire is versatile and can adapt to different voltage conditions.

Durable Construction: Made of **aluminum and ABS**, it offers durability and resistance, ensuring consistent performance.

CRI of 80: This luminaire ensures accurate color reproduction, creating vivid and natural illuminated environments.



Linear Bar Barcelona CCT



IP:
IP20
BRIGHTNESS:
4800
ANGLE:
120°
MATERIAL:
Aluminio/ABS
LIGHT SOURCE:
Osram
DRIVER:
Lifud
POWER SUPPLY:
170-265V AC
DURABILITY:
50000 Hr
CRI:
80

REF	W	SIZE	COLOR	°K
LM1186	40	1150X60X70H mm	Blanco / White	CCT



Includes Swift CCT

BARCELONA LINEAR BAR 40W (UGR 19) CCT

Fusión de tecnología innovadora y un diseño moderno se unen para crear una experiencia de iluminación excepcional.

Máxima Enlazabilidad: Versatilidad ilimitada, permitiéndote enlazar múltiples unidades para adaptarse a cualquier dimensión.

Potencia Eficiente: Con una potencia de **40 vatios** y la confiable fuente lumínica de **Osram**, la **barra LED Barcelona** garantiza un rendimiento óptimo.

Luminosidad Impresionante: Con una luminosidad de **4800 lúmenes**, la **barra Barcelona** ilumina de manera uniforme y brillante.

Ángulo Amplio: Ángulo de **120°**, asegura, una distribución uniforme de la luz, sin sombras y proporcionando una iluminación homogénea.

Vida Útil Prolongada: Vida útil de **50,000 horas**, asegurando durabilidad y confiabilidad.

Protección Confiable: Con un grado de protección **IP20**, la **barra Barcelona** está diseñada para resistir el polvo y protegerse contra salpicaduras.

Dimensiones Compactas: Dimensiones de **1150x60x70H mm** y con materiales de alta calidad como aluminio y **ABS** combinando eficiencia y diseño compacto.

Tecnología Avanzada: Driver **Lifud**, **CRI 90** y un factor de potencia de **0.95**, la **barra LED Barcelona** incorpora tecnología para ofrecer una calidad excepcional.

Accesorios Incluidos: La **barra Barcelona** Incluye uniones para enlazar, facilitando la instalación y permitiendo una mayor flexibilidad en la disposición de las luces.

Garantía Confiable: Garantía de **5 años**, ofreciendo tranquilidad y confianza en tu inversión.

Temperatura de color Ajustable: Personaliza la atmósfera de tu espacio con la temperatura de color **CCT**, asegurando la iluminación perfecta para cada ocasión.

Innovative technology and modern design come together to create an exceptional lighting experience.

Maximum Linkability: Unlimited versatility, allowing you to link multiple units to fit any dimension.

Efficient Power: With a power of 40 watts and the reliable Osram light source, the Barcelona LED bar ensures optimal performance.

Impressive brightness: With a brightness of 4800 lumens, the Barcelona bar illuminates evenly and brightly.

Wide angle: 120° angle ensures uniform light distribution, without shadows, providing homogeneous lighting.

Extended Lifespan: 50,000-hour lifespan, ensuring durability and reliability.

Reliable Protection: With an IP20 protection rating, the Barcelona bar is designed to resist dust and protect against splashes.

Compact Dimensions: Dimensions of 1150x60x70H mm and high-quality materials such as aluminum and ABS combine efficiency and compact design.

Advanced Technology: Lifud driver, CRI 90, and a power factor of 0.95, the Barcelona LED bar incorporates technology to offer exceptional quality.

Included Accessories: The Barcelona bar includes connectors for linking, facilitating installation and allowing greater flexibility in light arrangement.

Reliable Warranty: 5-year warranty, offering peace of mind and confidence in your investment.

Adjustable color Temperature: Customize the atmosphere of your space with CCT color temperature, ensuring the perfect lighting for every occasion.

Compatible accessories:



LF-GSD040PF
Driver Lifud Regulable
Dali Salida 20-42V Dc
40W No Flicker



LM3263
Colgadores Para Carril
Led 3M



LM2520
Driver Lifud Regulable
0-10V Salida 20-42V Dc



Emergency LED 4W Narlux Autotest



IP: IP20
BRIGHTNESS: 400
MATERIAL: Termoplastico/PC
LIGHT SOURCE: Led
POWER SUPPLY: 200-220V AC
DURABILITY: 30000 Hr
BATTERY: 3.6V 1200 mAh
FINISH: Blanco / White

REF	W	SIZE	COLOR	°K
LM1087	4	272X140X543 mm	Blanco / White	6500K



Zovy LED Emergency Autotest



IP: IP20
BRIGHTNESS: 280
MATERIAL: Termoplastico/PC
LIGHT SOURCE: Led
POWER SUPPLY: 200-220V AC
DURABILITY: 30000 Hr
BATTERY: 3.7V 1200 mAh
FINISH: Blanco / White

REF	W	SIZE	COLOR	°K
LM1081	3	260X90X50 mm	Blanco / White	6000K



AUTOTEST

La inspección mensual muestra que la luz verde parpadea durante **30 segundos al mes**.

La inspección anual muestra que la luz verde parpadea durante **2 minutos durante 1 año**.

Las inspecciones anuales y mensuales hacen que la luz verde parpadee durante la emergencia, y el estado de carga se devolverá automáticamente después de que se complete la inspección.

Las inspecciones mensuales y anuales se calculan **48 horas** después de que se usa el producto.

Presione rápidamente el botón de prueba dos veces para entrar al estado de inspección mensual, la luz verde parpadea lentamente, mientras parpadea durante la emergencia, volverá al estado de carga en aproximadamente **20-30 segundos**.

Presione rápidamente el botón **2 veces** para entrar al estado de inspección mensual, la luz verde parpadea rápidamente, parpadea durante la emergencia y regresa al estado de carga en aproximadamente **2 minutos**.

Presione rápidamente el botón **3 veces** para entrar al estado de inspección anual, la luz verde parpadea rápidamente, parpadea durante la emergencia y regresa al estado de carga en aproximadamente **2 minutos**.

AVISO

En el caso de que la batería de la luminaria dejara de funcionar la luz roja se apagaría.

Monthly inspection shows that the green light flashes for **30 seconds per month**.

Annual inspection shows that the green light flashes for **2 minutes per year**.

Monthly and annual inspections cause the green light to flash during emergencies, and the charging status will return automatically after the inspection is completed.

Monthly and annual inspections are calculated **48 hours** after the product is used.

Press the test button quickly twice to enter the monthly inspection state, the green light flashes slowly, while flashing during emergencies, it will return to the charging state in about **20-30 seconds**.

Press the button quickly twice to enter the monthly inspection state, the green light flashes rapidly, flashes during emergencies, and returns to the charging state in about **2 minutes**.

Press the button quickly **three times** to enter the annual inspection state, the green light flashes rapidly, flashes during emergencies, and returns to the charging state in about **2 minutes**.

NOTICE

In case the luminaire battery stops working, the red light will turn off.

Zovy LED Emergency Autotest Permanent / Non-Permanent

IP
IP20

BRIGHTNESS
400

MATERIAL
TERMOPLASTICO/PC

LIGHT SOURCE
LED

POWER SUPPLY
200-220V AC

DURABILITY
30000 Hr

BATTERY
3.7V 1200 mAh

FINISH
BLANCO / WHITE

REF	W	SIZE	COLOR	*K
LM1086	4	260X90X50 mm	Blanco / White	6000K



AUTOTEST

1. Pulsar dos veces seguidas para la activación del autotest mensual o 3 veces en el caso del autotest anual.

2. En el modo mensual la luz verde comenzara a parpadear lentamente, en el anual parpadeara mas rapido

Ya estaran configuradas los distintos modos

AVISO

En el caso de que la batería de la luminaria dejara de funcionar la luz roja se apagaría



Zovy LED Emergency Autotest Permanent / Non-Permanent

Presentamos la Luz de Emergencia Zovy, una solución luminosa confiable y versátil diseñada para proporcionar iluminación en situaciones críticas. Con la capacidad de elegir entre modos de encendido permanente y no permanente.

Fuente Luminosa LED: Equipada con tecnología LED ofrece una iluminación potente y eficiente, asegurando visibilidad en condiciones de emergencia.

Luminosidad: Luminosidad de **400 lm**, proporciona una iluminación intensa, facilitando la orientación y la evacuación en momentos críticos.

Vida Útil Prolongada: Diseñada para tener una vida útil de **30,000 hr**, asegurando un rendimiento constante y confiable.

Protección IP20: Resistente a la entrada de objetos sólidos, garantizando su funcionamiento incluso en condiciones menos favorables.

Opción de Encendido Permanente y No Permanente: Encendido permanente y no permanente, adaptándose a las necesidades específicas de iluminación y gestión de energía.

Batería Recargable: Equipada con una batería de **3.7V y 1200 mAh**, la Luz de **Emergencia Zovy** asegura un suministro constante de energía en situaciones críticas. La batería recargable garantiza una rápida recuperación tras su uso.

Versatilidad de Aplicación: Ideal para una variedad de entornos, desde oficinas y espacios comerciales hasta hogares y espacios públicos.

Introducing the Zovy Emergency Light, a reliable and versatile lighting solution designed to provide illumination in critical situations. With the ability to choose between permanent and non-permanent lighting modes.

LED light source: Equipped with LED technology, it offers powerful and efficient illumination, ensuring visibility in emergency conditions.

Brightness: 400 lm brightness provides intense illumination, facilitating orientation and evacuation in critical moments.

Extended Lifespan: Designed to have a lifespan of 30,000 hours, ensuring consistent and reliable performance.

IP20 Protection: Resistant to the ingress of solid objects, ensuring operation even in less favorable conditions.

Permanent and Non-Permanent Lighting Option: Permanent and non-permanent lighting options, adapting to specific lighting needs and energy management.

Rechargeable Battery: Equipped with a 3.7V and 1200 mAh battery, the Zovy Emergency Light ensures a constant power supply in critical situations. The rechargeable battery ensures quick recovery after use.

Application Versatility: Ideal for a variety of environments, from offices and commercial spaces to homes and public areas.

Recessed LED Beacon With PIR Sensor Nomis Square



IP:
IP20
BRIGHTNESS:
120
MATERIAL:
PC Ignifugo
LIGHT SOURCE:
Cob
POWER SUPPLY:
170-265V AC
DURABILITY:
30000 Hr
CRI:
80

REF	W	CUT	SIZE	COLOR	°K
LM9001	1,2	60X60 mm	85X85H mm	Blanco / White	4500K



PIR



10 LUX

Incluye sensor de movimiento PIR, con un mínimo de 10 lux se activara el sensor de movimiento, de esa manera permitirá el funcionamiento únicamente con la falta de claridad. Válido para cajas de mecanismos universales.

Includes PIR motion sensor, activating with a minimum of 10 lux to ensure operation only in low light conditions. Compatible with universal mechanism boxes.

Recessed LED Beacon Nomis Square



IP:
IP20
BRIGHTNESS:
120
MATERIAL:
PC Ignifugo
LIGHT SOURCE:
Cob
POWER SUPPLY:
170-265V AC
DURABILITY:
30000 Hr
CRI:
80

REF	W	SIZE	CUT	COLOR	°K
LM9003	1,2	60X60 mm	85X85H mm	Blanco / White	4500K







78.
Luxury Square Tilttable
Ring Series for GU10/
MR16



78.
Luxury Round Tilttable
Ring Series for GU10/
MR16



78.
Evo Series Round Tilting
Ring for GU10/MR16



79.
Eco Series Square Tilting
Ring for GU10/MR16



79.
Infinity Series Fixed
Round Ring for GU10/
MR16



79.
Eco Series Round Tilting
Ring for GU10/MR16



Aros GU10 / MR16 y
Accesorios



Rings GU10 / MR16
and Accesories



Luxury Square Tilttable Ring Series for GU10/MR16

REF	SIZE	CUT	COLOR
LM4323	90X90 mm	65 mm	Niquel / Nickel
LM4324	90X90 mm	65 mm	Blanco / White



Luxury Round Tilttable Ring Series for GU10/MR16



REF	SIZE	CUT	COLOR
LM4321	85 mm	65 mm	Niquel / Nickel
LM4322	85 mm	65 mm	Blanco / White



Evo Series Round Tilting Ring for GU10/MR16

REF	SIZE	CUT	COLOR
LM4325	93X40H mm	82 mm	Blanco / White
LM4326	93X40H mm	82 mm	Negro / Black





Eco Series Square Tilting Ring for GU10/MR16

REF	SIZE	CUT	COLOR
LM4319	85X85 mm	70X70 mm	Niquel / Nickel
LM4320	85X85 mm	70X70 mm	Blanco / White



Infinity Series Fixed Round Ring for GU10/MR16

REF	SIZE	CUT	COLOR
LM4338	83X35H mm	67 mm	Blanco / White
LM4339	83X35H mm	67 mm	Negro / Black



Eco Series Round Tilting Ring for GU10/MR16

REF	SIZE	CUT	COLOR
LM4317	85 mm	70 mm	Niquel / Nickel
LM4318	85 mm	70 mm	Blanco / White





82.
Ufo Light LED Inspire



84.
Ufo Light LED Serie A
Dali 2.0



86.
Ufo Light LED Serie A
1-10V



89.
Industrial Ufo Light
Elevator



Iluminación Industrial



Industrial
Lighting

UFO LIGHT LED INSPIRE 100W / 150W / 200W



QUALITY



Diseñada para iluminar tus espacios con eficiencia y estilo, estas luminarias están disponibles en Ws de 150W y 200W, brindando una iluminación potente y versátil para satisfacer todas tus necesidades.

Fuente lumínica: Tecnología **Lumileds**, garantizando una calidad de luz excepcional y una larga vida útil para una iluminación confiable a lo largo del tiempo.

Luminosidad: Con una luminosidad de **160 lm/w**, nuestras luminarias Inspire iluminarán eficazmente cada rincón de tus espacios.

Temperatura de trabajo: Diseñadas para enfrentar diversas condiciones ambientales, las luminarias Inspire pueden funcionar de manera eficiente en un rango de temperaturas que va desde **-20°C hasta +45°C**.

Ángulo: El ángulo de iluminación de **90°** permite una distribución uniforme de la luz, proporcionando una cobertura amplia.

Vida útil: Con una vida útil de **40000 hr**, las luminarias Inspire ofrecen un rendimiento duradero y confiable.

IP67 / IK10: Nuestras luminarias están diseñadas para resistir condiciones adversas.

Protección contra Sobretensión: Con una protección de hasta **6 kV** contra sobretensiones, nuestras luminarias Inspire están diseñadas para mantenerse seguras incluso en situaciones eléctricas imprevistas.

MATERIAL: Fabricadas en **ALUMINIO** y **PMMA**, las luminarias Inspire ofrecen durabilidad y resistencia a la corrosión, asegurando un rendimiento óptimo.

DRIVER: Equipadas con un driver **Mean Well**, nuestras luminarias Inspire garantizan un rendimiento eficiente y seguro.

CRI 85: Proporcionan una reproducción fiel de los Colores, mejorando la calidad visual de los espacios iluminados.

Factor de potencia: Aprovecha al máximo la energía suministrada, garantizando una eficiencia energética excepcional.

Garantía: Garantía líder en la industria de **5 años**, brindándote tranquilidad y confianza en tu elección.

Descubre el poder de la iluminación inspiradora con la serie Inspire. ¡Ilumina tu entorno con estilo y eficiencia!

Designed to illuminate your spaces with efficiency and style, these luminaires are available in 150W and 200W Ws, providing powerful and versatile lighting to suit all your needs.

Light source: Lumileds technology, guaranteeing exceptional light quality and long life for reliable illumination over time.

Brightness: With a brightness of 160 lm/w, our Inspire luminaires will effectively illuminate every corner of your spaces.

Working temperature: Designed to cope with diverse environmental conditions, Inspire luminaires can operate efficiently in a temperature range from **-20°C to +45°C**.

ANGLE: The 90° angle of illumination allows for even light distribution, providing wide coverage.

Lifetime: With a lifetime of 40000 hr, Inspire luminaires offer long-lasting and reliable performance.

IP67 / IK10: Our luminaires are designed to withstand harsh conditions.

Surge Protection: With up to 6 kV surge protection, our Inspire luminaires are designed to stay safe even in unforeseen electrical situations.

Material: Manufactured from **ALUMINIUM** and **PMMA**, Inspire luminaires offer durability and corrosion resistance, ensuring optimum performance.

Driver: Equipped with a Mean Well driver, our Inspire luminaires guarantee efficient and safe performance.

CRI 85: They provide faithful colour rendering, improving the visual quality of illuminated spaces.

Power factor: Makes the most of the energy supplied, ensuring exceptional energy efficiency.

Warranty: Industry-leading **5-year warranty**, giving you peace of mind and confidence in your choice.

Discover the power of inspirational lighting with the Inspire series - illuminate your environment with style and efficiency!

SPECIFICATIONS

ANGLE

90°

MATERIAL

ALUMINIO/PMMA

BRIGHTNESS

160 LM/W

LIGHT SOURCE

Osram

DURABILITY

50000 HR

OVERVOLTAGE PROTECTION

6 KV

POWER SUPPLY

100-277V AC

DRIVER

Mean Well

CRI

85

POWER FACTOR

0.98

DIMMABLE

1-10V

IP

IP65

IK

10



Compatible accessories:



LF-SCD010B

Pasarela Converter 1-10V 2 Hilos
A Dali Ip67

REF	W	SIZE	COLOR	DIMMABLE	°K
GA6733	100	280X280X120H mm	Negro / Black	1-10V	5700K
GA6734	100	280X280X120H mm	Negro / Black	1-10V	4500K
GA6735	150	340X340X125H mm	Negro / Black	1-10V	5700K
GA6736	150	340X340X125H mm	Negro / Black	1-10V	4500K
GA6737	200	410X410X140H mm	Negro / Black	1-10V	5700K
GA6738	200	410X410X140H mm	Negro / Black	1-10V	4500K





UFO LIGHT LED SERIE A DALI 2.0 200W



Con una luminosidad excepcional de 180 lúmenes por vatio, nuestra Campana LED Serie A DALI 2.0 de ISG LIGHTING ilumina cada rincón con una potencia impresionante. Su vida útil extendida de 70,000 horas no solo ofrece una iluminación fiable a largo plazo, sino que también reduce significativamente los costos de mantenimiento, brindándole tranquilidad y eficiencia.

La protección avanzada contra sobretensiones de hasta 4 kV asegura que su inversión esté segura ante fluctuaciones eléctricas, garantizando un funcionamiento continuo y sin preocupaciones. Además, con un índice de protección IP65, esta campana se defiende contra polvo y agua, siendo una solución robusta incluso en los entornos más desafiantes.

El índice de reproducción cromática (CRI) de 70 asegura una representación precisa de los Colores, esencial para entornos industriales donde la claridad visual es primordial. El factor de potencia de 0.95 REFleja la eficiencia energética de esta campana, convirtiendo la mayoría de la energía suministrada en luz útil.

Con un índice de protección IK8, esta campana LED industrial demuestra una resistencia excepcional contra impactos y vandalismo, garantizando su integridad en entornos más desafiantes. Además, la regulación mediante la avanzada tecnología Dali 2.0 ofrece un control preciso y flexible sobre la intensidad lumínica, adaptándose a sus necesidades específicas en cada momento.

En resumen, la Campana LED Industrial de ISG LIGHTING combina rendimiento superior, eficiencia energética y durabilidad incomparable. Descubra la iluminación perfecta para su entorno industrial con la innovación y calidad de ISG LIGHTING.

With an exceptional brightness of 180 lumens per watt, our ISG LIGHTING Serie A DALI 2.0 LED A-Bell illuminates every corner with impressive power. Its extended lifetime of 70,000 hours not only offers long-term reliable illumination, but also significantly reduces maintenance costs, giving you peace of mind and efficiency.

Advanced surge protection up to 4 kV ensures that your investment is safe from electrical fluctuations, guaranteeing continuous, worry-free operation. In addition, with an IP65 protection rating, this canopy defends against dust and water, making it a robust solution even in the most challenging environments.

The colour rendering index (CRI) of 70 ensures accurate colour rendering, essential for industrial environments where visual clarity is paramount. The power factor of 0.95 REFlects the energy efficiency of this canopy, converting most of the energy supplied into usable light.

With an IK8 protection rating, this industrial LED canopy demonstrates exceptional resistance to impact and vandalism, ensuring its integrity in more challenging environments. In addition, dimming using advanced Dali 2.0 technology offers precise and flexible control over light intensity, adapting to your specific needs at all times.

In short, ISG LIGHTING's Industrial LED Bell combines superior performance, energy efficiency and unmatched durability. Discover the perfect lighting for your industrial environment with ISG LIGHTING innovation and quality.



REF	W	SIZE	COLOR	DIMMABLE	*K
GA6787	200	380X130H mm	Negro / Black	Dali 2.0	5000K
GA6788	200	380X130H mm	Negro / Black	Dali 2.0	4000K



SPECIFICATIONS

ANGLE
90°

MATERIAL
ALUMINIO

BRIGHTNESS
180 LM/W

LIGHT SOURCE
Osram

DURABILITY
70000 HR

OVERVOLTAGE PROTECTION
4 KV

POWER SUPPLY
220-240V AC

DRIVER
LIFUD

CRI
70

POWER FACTOR
0.95

DIMMABLE
Dali 2.0

IP
IP65

IK
8





UFO LIGHT LED SERIE A 1-10V 100W / 150W / 200W / 300W



Diseñada para elevar la eficiencia y la calidad lumínica en entornos industriales exigentes. Esta campana, equipada con la innovadora tecnología de light source Osram, se posiciona como un REferente en el mercado gracias a sus características excepcionales.

Con una luminosidad de **180 lm/w**, esta Campana LED Industrial ilumina cada rincón de su espacio de trabajo con claridad y uniformidad excepcionales. Su vida útil extraordinaria de **70,000 horas** garantiza una inversión a largo plazo, reduciendo los costos de mantenimiento y asegurando un rendimiento duradero.

La protección contra sobretensiones de **4 kV** proporciona una seguridad adicional, asegurando que la campana LED de **ISG LIGHTING** permanezca resistente ante condiciones eléctricas adversas. Su índice de protección **IP65** asegura un funcionamiento sin interrupciones incluso en entornos industriales adversos.

El índice de reproducción cromática (**CRI**) de **70** garantiza la reproducción fiel de los Colores, crucial en entornos donde la precisión visual es esencial. Además, con un **POWER FACTOR** de **0.95**, esta campana demuestra su eficiencia energética al convertir la mayoría de la energía suministrada en luz utilizable.

La posibilidad de **regulación mediante tecnología 1-10V** brinda un control total sobre la intensidad de la luz, adaptándose a las necesidades específicas de cada momento. Ya sea para un ambiente de trabajo más brillante o para ahorrar energía durante períodos menos activos.

En resumen, la Campana LED Industrial de ISG LIGHTING es la elección ideal para aquellos que buscan una solución de iluminación de alta calidad, eficiente y duradera en entornos industriales. Experimente la combinación perfecta de rendimiento lumínico excepcional y tecnología de vanguardia.

Designed to increase efficiency and light quality in demanding industrial environments. Equipped with the innovative light source Osram technology, this hood is positioned as a benchmark in the market thanks to its exceptional features.

With a luminance of **180 lm/w**, this Industrial LED hood illuminates every corner of your workspace with exceptional brightness and uniformity. Its extraordinary lifetime of **70,000 hours** guarantees a long-term investment, reducing maintenance costs and ensuring long-lasting performance.

The **4 kV** surge protection provides additional safety, ensuring that the ISG LIGHTING LED canopy remains resistant to adverse electrical conditions. Its **IP65** protection rating ensures uninterrupted operation even in harsh industrial environments.

The colour rendering index (**CRI**) of **70** guarantees faithful colour rendering, crucial in environments where visual accuracy is essential. In addition, with a **POWER FACTOR** of 0.95, this canopy demonstrates its energy efficiency by converting most of the energy supplied into usable light.

Dimmability via 1-10V technology gives total control over the intensity of the light, adapting to the specific needs of the moment. Whether for a brighter working environment or to save energy during less active periods.

In short, ISG LIGHTING's Industrial LED Bell is the ideal choice for those looking for a high quality, efficient and long-lasting lighting solution in industrial environments. Experience the perfect combination of exceptional light performance and state-of-the-art technology.



REF	W	SIZE	COLOR	DIMMABLE	°K
GA6761	100	253X149H mm	Negro / Black	1-10V	5000K
GA6762	100	253X155H mm	Negro / Black	1-10V	4000K
GA6763	150	308X155H mm	Negro / Black	1-10V	5000K
GA6764	150	308X160H mm	Negro / Black	1-10V	4000K
GA6765	200	354X160H mm	Negro / Black	1-10V	5000K
GA6766	200	354X160H mm	Negro / Black	1-10V	4000K
GA6769	300	400X160H mm	Negro / Black	1-10V	5000K
GA6770	300	400X160H mm	Negro / Black	1-10V	4000K



Compatible accessories:



LF-SCD010B
Pasarela Convertor
1-10V 2 Hilos A Dali Ip67



GA6767
Sensor de Movimiento
Radar Ip65 Para Campa-
na Led Serie A



GA6768
Mando Control Para
Campana Serie A

SPECIFICATIONS

ANGLE
90°

MATERIAL
ALUMINIO

BRIGHTNESS
180 LM/W

LIGHT SOURCE
Osram

DURABILITY
70000 HR

OVERVOLTAGE PROTECTION
4 KV

POWER SUPPLY
220-240V AC

DRIVER
LIFUD

CRI
70

POWER FACTOR
0.95

DIMMABLE
1-10V
IP
IP65





Control Remote Ufo Light Serie A



FUNCIÓN ON/OFF

Presionar el botón "ON / OFF" pasa al modo de encendido permanente o apagado.

- Presione los botones "Modo automático", "Reiniciar" o "Modo de escena" para salir de este modo.

ON/OFF FUNCTION

Press the "ON / OFF" button to switch to permanent on or off mode.

- Press the "Auto Mode", "RESET" or "Scene Mode" buttons to exit this mode.

Auto Mode

MODO SENSOR

Presione el botón "Modo automático", el sensor comenzará a funcionar y todas las configuraciones permanecerán igual que el último estado antes de que se encendiera o apagara la luz.

SENSOR MODE

Press the "Auto Mode" button, the sensor will start to operate and all settings will remain the same as the last state before the light was switched on or off.

RESET

FUNCIÓN RESET

Presione el botón "RESET", todas las configuraciones volverán al valor de las configuraciones del interruptor DIP.

RESET FUNCTION

Press the "RESET" button, all settings will return to the value of the DIP switch settings.



Dim +/-

Mantenga presionado "Dim +" "Dim -" para ajustar

el brillo de la luz durante el tiempo de espera. "+" significa atenuación ascendente, "-" significa atenuación descendente.

Dim +/-

Press and hold "Dim +" "Dim -" to adjust the brightness of the light during standby time. "+" means upward dimming, "-" means downward dimming.

TEST
2S

MODO TEST

El botón "Test 2s" es solo para fines de prueba. El sensor pasa al modo de prueba (el tiempo de espera es de 2 s) automáticamente después de la puesta en marcha, mientras que el período de espera y el sensor de luz diurna están desactivados.

Este modo se puede finalizar presionando "reiniciar" o cualquier botón de "modo de escena" y "tiempo de espera". El ajuste del sensor se cambia en consecuencia.

TEST MODE

The "Test 2s" button is for test purposes only. The sensor goes into test mode (timeout is 2s) automatically after start-up, while the timeout period and daylight sensor are disabled.

This mode can be terminated by pressing "RESET" or any button of "scene mode" and "timeout". The sensor setting is changed accordingly.

Power
100% 80%

SALIDA DE POTENCIA

Presione estos botones para seleccionar el nivel de salida completo. El botón del 80% permite el ahorro de energía y la atenuación inversa para compensar la depreciación del lumen del LED con el tiempo. Admite bur-in inicial fluorescente de 10.000 hr.

POWER OUTPUT

Press these buttons to select the full output level. The 80% button allows power saving and reverse dimming to compensate for LED lumen depreciation over time. Supports initial fluorescent bur-in of 10,000 hr.

Lux
disable

DESHABILITAR LUX

Presione este botón para desactivar el sensor de luz diurna para el control de umbral. Cuando se detecta movimiento, el dispositivo siempre se encenderá, independientemente del nivel de la luz ambiental.

DISABLE LUX

Press this button to disable the daylight sensor for threshold control. When motion is detected, the device will always turn on, regardless of the ambient light level.

MODO ESCENA

Hay cuatro programas fijos de modos de escena integrados en el control remoto. Seleccione según corresponda. Cada escena se puede modificar usando el control remoto. El sensor recordará las actualizaciones incluso después de un corte de energía. El botón Green "RESET" en el control remoto vuelve a los valores predeterminados originales.

SCENE MODE

There are four fixed programmes of scene modes built into the remote control. Select accordingly. Each scene can be modified using the remote control. The sensor will remember the updates even after a power failure. The green "RESET" button on the remote control returns to the original default values.

NOTA: El usuario final puede ajustar la configuración presionando los botones de rango de detección/tiempo de espera/período de espera/nivel de atenuación de espera/sensor de luz diurna. La última configuración permanece en vigencia.

NOTE: The end user can adjust the setting by pressing the detection range/standby time/standby period/standby dimming level/daylight sensor buttons. The last setting remains in effect.

Escena / Scene	Rango / Range	Espera / Wait	Stand-by	Stand-by nivel	Sensor luz diurna Daylight sensor
SC1	100%	1 min	10 min	10%	2 Lux
SC2	100%	5 min	10 min	10%	2 Lux
SC3	100%	10 min	30 min	10%	10 Lux
SC4	100%	10 min	+∞	10%	50 Lux

RANGO DE DETECCIÓN

Seleccione según corresponda para ajustar/reducir la sensibilidad del sensor, rango de detección del 100 %. Consulte el patrón de detección.

DETECTION RANGE

Select as appropriate to adjust/reduce the sensor sensitivity, 100 % detection range. REFER to the detection pattern.



MAX WEIGHT:
7.5 Kg
EXTENSION:
0-10 metros
POWER SUPPLY:
220-240V ac
IP:
IP65
DURABILITY:
30000 Hr
MATERIAL:
Metal / PC

REF	W	SIZE	COLOR
LM9010	25	300X220 mm	Negro / Black



Maximum height of 10 meters

Maximum weight 0-10 kg

Automatic luminaire disconnection upon activation

An easier day

El elevador para luminarias LED, está pensado para realizarnos un mantenimiento más sencillo, libre de plataformas elevadoras o de posibles riesgos laborales provocados por trabajos realizados en altura.

Cada Elevador de Campanas dispone de un control remoto único por radiofrecuencia.

El control remoto nos permite un alcance de hasta **25 metros** de distancia, cada frecuencia es única, permitiéndonos una única conexión por cada elevador, garantizaremos que se puedan manejar de manera individual cada elevador y no se realice un control por grupos, evitando que se haga uso de otros elevadores que no sea necesaria su utilización en el momento.

La luminaria quedará libre de tensión en el momento que la comience a descolgarse, de esa manera podremos garantizar un trabajo seguro, con la finalidad de evitar riesgos eléctricos.

El peso máximo a soportar por la luminaria es de **7,5 kg**.

The lift for LED luminaires is designed for easier maintenance, free of lifting platforms or possible occupational hazards caused by working at heights.

Each Bell Lift has a unique radio frequency remote control.

The remote control allows us a range of up to **25 metres**, each frequency is unique, allowing us a single connection for each elevator, ensuring that each elevator can be managed individually and not be controlled by groups, avoiding the use of other elevators that are not necessary to use at the time.

The luminaire will be de-energised as soon as it starts to be taken down, so that we can guarantee safe work, with the aim of avoiding electrical risks.

The maximum weight to be supported by the luminaire is **7.5 kg**.





92. LED Wall Light with Motion Sensor Sphere 12W PIR 360°



92. LED Wall Light Cinza CCT



92. LED Wall Light Dynamic CCT



92. LED Tube Wall Sconce 2X3W



93. LED Tube Wall Sconce



93. Wall Light Urban



93. Wall Light Cam



93. Wall Light Design



94. Beacon Design Plus



94. Beacon Design Plus



94. Beacon Double Urban



94. Beacon Urban



96. LED Wall Light Cube IP54



97. Surface-mounted 3W LED Beacon Biral



97. Recessed LED Circle Beacon



97. GubBet Recessed Ground Spotlight Circular with GU10 Socket



97. GubBet Recessed Ground Spotlight Square with GU10 Socket



98. Portable LED Projector Spotlight with Laptop Battery



100. Ventur Spike Projector Spotlight for GU10



101. LED fixture Oval Screw



101. LED fixture Screw



101. LED fixture Light with Motion Sensor Sphere



102. LED Floodlight Napoli RGB



102. LED Floodlight LED Slim Series



103. Napoli LED Floodlight with Motion Sensor



104. LED Floodlight LED SMD Pro



104. Modular spotlight LED Retrofit



104. Modular spotlight LED Premium



104. Wall Washer Foss



106. Floodlight Led Infinity



107. Floodlight LED Stadium



108. Floodlight LED Coliseum



109. Floodlight LED Coliseo 250W



110. Floodlight LED PLANET



112. Wall Sconce Led Fit 10W



112. Wall Sconce Led Metse 10W



112. Wall Sconce Led Dakota 12W



112. Wall Sconce Led Globe 10W



113. Wall Sconce Led Mirror 10W



113. Wall Sconce Led Arrow 10W



113. Wall Sconce Led World 10W



113. Wall Sconce Led Hubb 10W



114. Wall Sconce Led Nian 10W



114. Wall Sconce Led Fine 10W



114. Wall Sconce Led Lounge 10W



114. Wall Sconce Led Falcon 6W



115. Wall Sconce Led Ian 10W



115. Wall Sconce Led Vera 6W

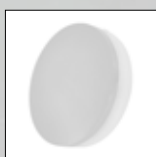

115. LED Flush Mount Round Nature 24-18-15-12W Ip65



115. LED Surface Beacon Wall Long Rectangular 5W

Alumbrado Exterior



Exterior
Lighting

LED Wall Light with Motion Sensor Sphere 12W PIR 360°



IP:
IP64
LIGHT SOURCE:
Smd Led
ANGLE:
120°
MATERIAL:
PC
BRIGHTNESS:
960
WORKING TIME:
-20°C + 40°C
POWER SUPPLY:
220-240V ac
DETECTION ANGLE:
360°
DETECTION DISTANCE:
6 m
TIME MIN/MAX:
10 seg - 75 seg
DURABILITY:
30000 Hr
CRI:
80
REGULATION TIME:
Starting from 10 lux

REF	W	SIZE	COLOR	°K
LM8225	12	170X75H mm	Blanco / White	6000K
LM8226	12	170X75H mm	Blanco / White	4500K



LED Wall Light Cinza CCT



IP:
IP65
BRIGHTNESS:
840
ANGLE:
180°
MATERIAL:
Aluminium / PC
POWER SUPPLY:
175-265V ac
LIGHT SOURCE:
Lumileds
DURABILITY:
30000 Hr
CRI:
80

REF	W	SIZE	COLOR	°K
LM6118	12	170X170X100H mm	Negro / Black	CCT



Includes Swift CCT

LED Wall Light Dynamic CCT



IP:
IP65
BRIGHTNESS:
840
ANGLE:
180°
MATERIAL:
Aluminium / PC
POWER SUPPLY:
175-265V ac
LIGHT SOURCE:
Lumileds
DURABILITY:
30000 Hr
CRI:
80

REF	W	SIZE	COLOR	°K
LM6117	12	170X170X95H mm	Negro / Black	CCT



Includes Swift CCT

LED Tube Wall Sconce 2X3W



IP:
IP54
ANGLE:
36°
MATERIAL:
Aluminium / Cristal
POWER SUPPLY:
170-265V ac
BRIGHTNESS:
540
LIGHT SOURCE:
Cob
DURABILITY:
30000 Hr
CRI:
80

REF	W	SIZE	COLOR	°K
LM6179	6	130X112H mm	Negro / Black	3000K
LM6188	6	130X112H mm	Blanco / White	3000K



LED Tube Wall Sconce



IP:
IP54
MATERIAL:
Aluminium / Cristal
POWER MAX:
40
LIGHT SOURCE:
2XGU10

REF	SIZE	COLOR
LM6189	191X112 mm	Negro / Black
LM6196	191X112 mm	Blanco / White



Wall Light Urban



IP:
IP44
MATERIAL:
Aluminium / PMMA
POWER MAX:
40
LIGHT SOURCE:
GU10

REF	SIZE	COLOR
LM6169	130X172,5H mm	Negro / Black



Wall Light Cam



IP:
IP44
MATERIAL:
Aluminium / PMMA
POWER MAX:
40
LIGHT SOURCE:
E27

REF	SIZE	COLOR
LM6168	214X180X278H mm	Negro / Black



Wall Light Design



IP:
IP54
MATERIAL:
Aluminium / PMMA
POWER MAX:
40
LIGHT SOURCE:
E27

REF	SIZE	COLOR
LM7311	80X112X160H mm	Negro / Black



Beacon Design Plus



IP:
IP54
MATERIAL:
Aluminium / PMMA
POWER MAX:
40
LIGHT SOURCE:
E27

REF	SIZE	COLOR
LM7312	80X80X440H mm	Negro / Black
LM7313	80X80X740H mm	Negro / Black



Beacon Cam



IP:
IP44
MATERIAL:
Aluminium / PMMA
POWER MAX:
40
LIGHT SOURCE:
E27

REF	SIZE	COLOR
LM7314	180X500H mm	Negro / Black
LM7315	180X800H mm	Negro / Black



Beacon Double Urban



IP:
IP44
MATERIAL:
Aluminium / PMMA
POWER MAX:
40
LIGHT SOURCE:
2XGU10

REF	SIZE	COLOR
LM7317	216X440H mm	Negro / Black



Beacon Urban



IP:
IP44
MATERIAL:
Aluminium / PMMA
POWER MAX:
40
LIGHT SOURCE:
GU10

REF	SIZE	COLOR
LM7316	104X440H mm	Negro / Black



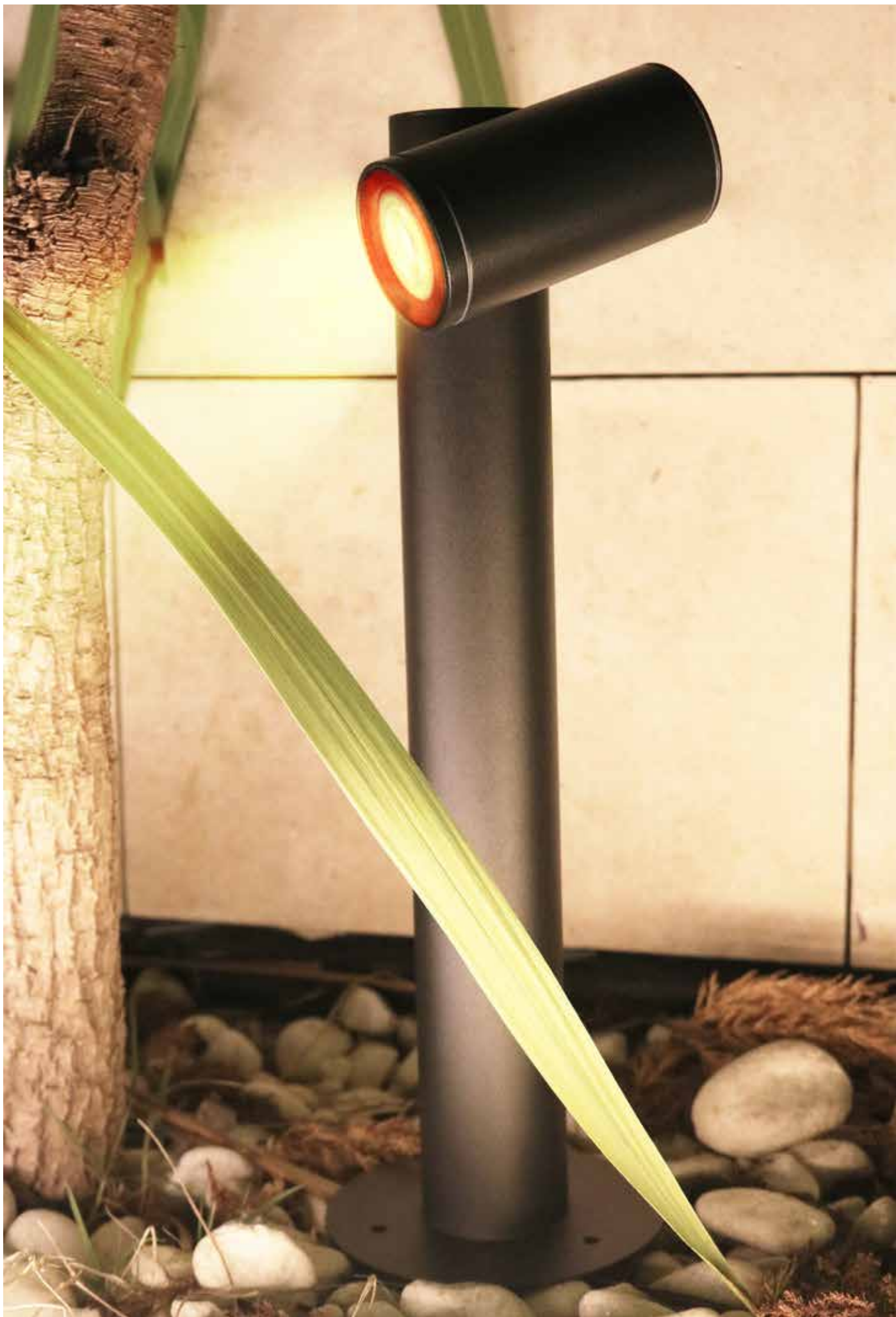

LED Wall Light Cube IP54



IP:
IP54
ANGLE:
10°-30°
MATERIAL:
Aluminium
POWER SUPPLY:
170-265V ac
BRIGHTNESS:
600
LIGHT SOURCE:
Epistar
DURABILITY:
50000 Hr
CRI:
80

REF	W	SIZE	BRIGHTNESS	COLOR	°K
LM6183	12	100X100X100H	900	Blanco / White	CCT
LM6184	12	100X100X100H	900	Negro / Black	CCT
LM6182	6	100X100X100H	600	Negro / Black	3000K
LM6197	6	100X100X100H	600	Blanco / White	3000K



LED Wall Light Series Cube 12W / 6W

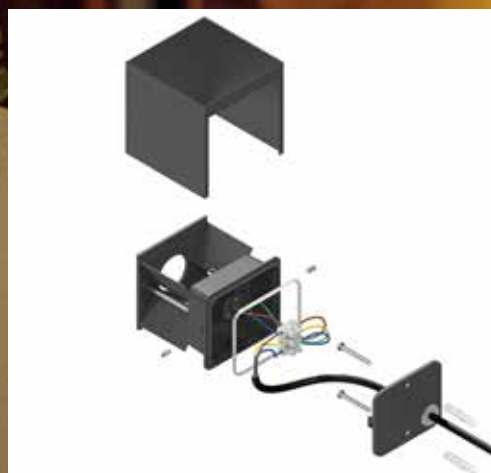

6W / 12W

La serie de apliques **LED Cube** es una opción moderna y elegante para iluminar cualquier espacio.

Con su diseño minimalista y sofisticado, este aplique se adapta perfectamente a cualquier estilo de decoración, ya sea en hogares, oficinas o comercios.

Una de las características más destacadas de este aplique es su fuente lumínica **Epistar**, que garantiza una iluminación de alta calidad y durabilidad. La tecnología LED de **Epistar** ofrece un rendimiento excepcional, proporcionando una luz brillante y uniforme.

La fuente lumínica de este aplique es de **100 LM/W**, lo que significa que es muy eficiente en términos de consumo energético.

Con esta eficiencia, podrás disfrutar de una iluminación potente sin preocuparte por el gasto excesivo en tu factura de electricidad.

The LED Cube series is a modern and elegant choice for illuminating any space.

With its minimalist and sophisticated design, this wall light blends seamlessly with any decor style, whether in homes, offices, or commercial settings.

One of the standout features of this wall light is its **Epistar** light source, ensuring high-quality and durable lighting. **Epistar's** LED technology delivers exceptional performance, providing bright and uniform light.

The luminous efficacy of this wall light is **100 LM/W**, meaning it's highly efficient in terms of energy consumption.

With this efficiency, you can enjoy powerful illumination without worrying about excessive energy costs on your electricity bill

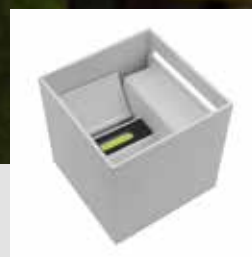
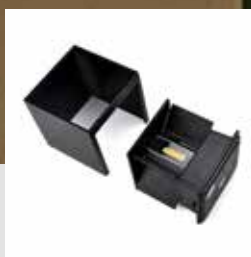

Surface-mounted 3W LED Beacon Biral



IP:
IP54
ANGLE:
36°
MATERIAL:
Aluminium
POWER SUPPLY:
170-265V ac
BRIGHTNESS:
240
LIGHT SOURCE:
Epistar
DURABILITY:
40000 Hr
CRI:
80

REF	W	SIZE	COLOR	°K
LM6194	3	80X75X50 mm	Negro / Black	3000K



Recessed LED Circle Beacon



IP:
IP54
ANGLE:
36°
MATERIAL:
Aluminium
POWER SUPPLY:
170-265V ac
BRIGHTNESS:
240
LIGHT SOURCE:
Epistar
DURABILITY:
40000 Hr
CRI:
80

REF	W	SIZE	CUT	COLOR	°K
LM6193	3	82X40 mm	65 mm	Negro / Black	3000K



GubBet Recessed Ground Spotlight Circular with GU10 Socket



IP:
IP67
MATERIAL:
Acero / PC
POWER MAX:
40
LIGHT SOURCE:
GU10

REF	SIZE	CUT	COLOR
LM7303	110X130H mm	100 mm	Acero Inoxidable



GubBet Recessed Ground Spotlight Square with GU10 Socket



IP:
IP67
MATERIAL:
Acero / PC
POWER MAX:
40
LIGHT SOURCE:
GU10

REF	SIZE	CUT	COLOR
LM7302	110X110X130H mm	100 mm	Acero Inoxidable



Portable LED Projector Spotlight with Laptop Battery



IP:
IP65
ANGLE:
120°
MATERIAL:
Aluminium / PMMA
POWER SUPPLY:
180-220V ac
BRIGHTNESS:
90 LM/W
LIGHT SOURCE:
Epistar
DURABILITY:
30000 Hr
CRI:
80
TIME CHARGE:
8 Hr
TIME USE:
4-8 Hr

REF	W	Bateria	SIZE	COLOR	°K
LM6031	20	3.2V 5000mAH	260X283H mm	Black / Yellow	6000
LM6032	30	3.2V 6000mAH	296X315H mm	Black / Yellow	6000
LM6033	50	3.2V 12000mAH	352X345H mm	Black / Yellow	6000



180° DEGREE TURN

CHARGE TIME 8 HR





● 3.2V 5000MAH

● EPISTAR LED

● IP65

● REMOTE CONTROL INCLUDED

● ALUMINIUM/PMMA

Ventur Spike Projector Spotlight for GU10



SPECIFICATIONS

IP
IP54

MATERIAL
Aluminium

LIGHT SOURCE
GU10

MAX POWER
40

REF

LM7301

SIZE

100X310H mm

COLOR

Negro / Black

LED fixture Oval Screw



IP:
IP65
ANGLE:
120°
MATERIAL:
PC
POWER SUPPLY:
110-240V ac
BRIGHTNESS:
2000
LIGHT SOURCE:
Epistar
DURABILITY:
25000 Hr
CRI:
70

REF	W	SIZE	COLOR	°K
LM8241	20	268X143HX78 mm	Blanco / White	6000K
LM8242	20	268X143HX78 mm	Blanco / White	4500K



LED fixture Screw



IP:
IP65
ANGLE:
120°
MATERIAL:
PC
POWER SUPPLY:
110-240V ac
BRIGHTNESS:
2000
LIGHT SOURCE:
Epistar
DURABILITY:
25000 Hr
CRI:
70

REF	W	SIZE	COLOR	°K
LM8243	20	219X68 mm	Blanco / White	6000K
LM8244	20	219X68 mm	Blanco / White	4500K



LED fixture Light with Motion Sensor Sphere



IP:
IP54
LIGHT SOURCE:
Smd Led
ANGLE:
120°
MATERIAL:
PC
BRIGHTNESS:
960
WORKING TIME:
-20°C + 40°C
POWER SUPPLY:
220-240V ac
DETECTION ANGLE:
120°
DETECTION DISTANCE:
6 m
TIME MIN/MAX:
10 seg - 75 seg
DURABILITY:
30000 Hr
CRI:
80
REGULATION TIME:
a partir de 10 lux

REF	W	SIZE	COLOR	°K
LM8215	12	230X105X40H mm	Blanco / White	6000K
LM8216	12	230X105X40H mm	Blanco / White	4500K



LED Floodlight Napoli RGB



IP:
IP65
ANGLE:
120°
MATERIAL:
Aluminium / Cristal
POWER SUPPLY:
180-265V ac
LIGHT SOURCE:
Osram
DURABILITY:
50000 Hr
CRI:
80
WORKING TIME:
-20°C + 45°C
IK:
8
KV:
2 Kv
POWER FACTOR:
0,98
DIMMABLE:
Si
WAVELENGTH:
R-620-630/ G510-525
B455-470 nm

REF	W	SIZE	COLOR	°K
LM6511	20	120,4HX104X22,8 mm	Negro / Black	RGB
LM6512	50	194,9HX164,2X31,7 mm	Negro / Black	RGB
LM6513	100	223,8HX198,6X33 mm	Negro / Black	RGB



Included Remote control

Iluminación Exterior / Projectores LED SMD - Outdoor Lighting / SMD LED Projectors

LED Floodlight LED Slim Series



IP:
IP65
ANGLE:
90°
MATERIAL:
Aluminium / Cristal
POWER SUPPLY:
100-277V ac
BRIGHTNESS:
140 LM/W
LIGHT SOURCE:
Lumileds
DURABILITY:
50000 Hr
CRI:
70
DIMMABLE:
1-10V

REF	W	SIZE	COLOR	°K
LM6570	100	343X369HX56 mm	Negro / Black	5000K
LM6571	100	343X369HX56 mm	Negro / Black	4000K
LM6573	150	343X369HX56 mm	Negro / Black	5000K
LM6574	150	343X369HX56 mm	Negro / Black	4000K
LM6576	200	368X412HX58 mm	Negro / Black	5000K
LM6577	200	368X412HX58 mm	Negro / Black	4000K
LM6579	300	393X422HX58 mm	Negro / Black	5000K
LM6580	300	393X422HX58 mm	Negro / Black	4000K



Iluminación Exterior / Projectores LED SMD - Outdoor Lighting / SMD LED Projectors

LED Floodlight Led Napoli Plus



IP:
IP65
ANGLE:
120°
MATERIAL:
Aluminium / Cristal
POWER SUPPLY:
200-265V AC
BRIGHTNESS:
120 LM/W
LIGHT SOURCE:
Osram
DURABILITY:
30000 Hr
CRI:
80
DIMMABLE:
Triac
POWER FACTOR
0,9

REF	W	SIZE	COLOR	°K
LM6801	20	114X147HX25 mm	Negro / Black	6000K
LM6802	20	114X147HX25 mm	Negro / Black	4000K
LM6803	20	114X147HX25 mm	Negro / Black	3000K
LM6807	50	186X222HX30 mm	Negro / Black	6000K
LM6808	50	186X222HX30 mm	Negro / Black	4000K
LM6809	50	186X222HX30 mm	Negro / Black	3000K
LM6810	100	223X263HX30 mm	Negro / Black	6000K
LM6811	100	223X263HX30 mm	Negro / Black	4000K
LM6812	100	223X263HX30 mm	Negro / Black	3000K
LM6813	150	252X302HX33 mm	Negro / Black	6000K
LM6814	150	252X302HX33 mm	Negro / Black	4000K
LM6815	150	252X302HX33 mm	Negro / Black	3000K
LM6816	200	288X345HX33 mm	Negro / Black	6000K
LM6817	200	288X345HX33 mm	Negro / Black	4000K
LM6818	200	288X345HX33 mm	Negro / Black	3000K



Napoli LED Floodlight with Motion Sensor



IP:
IP65
ANGLE:
120°
MATERIAL:
Aluminium / Cristal
POWER SUPPLY:
170-265V ac
BRIGHTNESS:
120 LM/W
LIGHT SOURCE:
Epistar
DURABILITY:
30000 Hr
CRI:
80
IK:
6
POWER FACTOR:
0.9
DETECTION ANGLE:
180°
DETECTION DISTANCE:
8 m
TIME MIN-MAX:
20 seg - 8 hr

REF	W	SIZE	COLOR	°K
LM6515	20	120,4X104X22,8 mm	Negro / Black	6000K
LM6516	30	164,2X194,90HX31,7 mm	Negro / Black	6000K
LM6517	100	198,6X233,8HX33 mm	Negro / Black	6000K



Included
Remote control

Motion Light



Activación del sensor a partir de **20 Lux**
Angulo de detección **180°**
Distancia de detección **8 metros**.

ON/OFF: Encender y apagar.
8H: Enciende **8 horas**.
20s: Luz temporizada durante **20 segundos**.
1M: Luz temporizada durante **1 minuto**.
2M: Luz temporizada durante **2 minutos**.
5M: Luz temporizada durante **5 minutos**.
10M: Luz temporizada durante **10 minutos**.
30M: Luz temporizada durante **30 minutos**.

Sensor activation starting from **20 Lux**
Detection angle **180°**
Detection distance **8 meters**.

ON/OFF: Turn on and off.
8H: Turns on for **8 hours**.
20s: Light timed for **20 seconds**.
1M: Light timed for **1 minute**.
2M: Light timed for **2 minutes**.
5M: Light timed for **5 minutes**.
10M: Light timed for **10 minutes**.
30M: Light timed for **30 minutes**.



LED Floodlight LED SMD Pro



IP:
IP65
ANGLE:
120°
MATERIAL:
Aluminium / Cristal
POWER SUPPLY:
170-265V ac
BRIGHTNESS:
110 LM/W
LIGHT SOURCE:
Sanan
DURABILITY:
30000 Hr
CRI:
70
POWER FACTOR:
0.98
IK:
8
KV:
4 Kv
WORKING TIME:
-20°C + 45°C

REF	W	SIZE	COLOR	°K
LM6658	30	190X235X57 mm	Negro / Black	6000K
LM6659	50	240X281HX64 mm	Negro / Black	6000K
LM6663	50	240X281HX64 mm	Negro / Black	4500K
LM6664	50	240X281HX64 mm	Negro / Black	3000K
LM6660	100	284X334X85mm	Negro / Black	6000K
LM6665	100	284X334X85mm	Negro / Black	4500K
LM6666	100	284X334X85mm	Negro / Black	3000K
LM6661	150	310X345HX85 mm	Negro / Black	6000K
LM6667	150	310X345HX85 mm	Negro / Black	4500K
LM6668	150	310X345HX85 mm	Negro / Black	3000K
LM6662	200	310X345HX215 mm	Negro / Black	6000K
LM6670	200	310X345HX215 mm	Negro / Black	4500K
LM6671	200	310X345HX215 mm	Negro / Black	3000K



Illuminación Exterior / Proyector Modulares LED / Alumbrado Público

Modular spotlight LED Retrofit



IP:
IP65
ANGLE:
90°
MATERIAL:
Aluminium
POWER SUPPLY:
100-277V ac
BRIGHTNESS:
6500
LIGHT SOURCE:
Sanan
DURABILITY:
30000 Hr
CRI:
70
POWER FACTOR:
0.98

REF	W	SIZE	COLOR	°K
LM6441	50	295X38X75H mm	Gris / Gray	6000K
LM6442	50	295X38X75H mm	Gris / Gray	4000K
LM6440	50	295X38X75H mm	Gris / Gray	3000K



Included Driver

Illuminación Exterior / Proyector Modulares LED

Modular spotlight LED Premium



IP:
IP65
ANGLE:
90°
MATERIAL:
Aluminium / PMMA
POWER SUPPLY:
100-265V ac
BRIGHTNESS:
120 LM/W
LIGHT SOURCE:
Sanan
DURABILITY:
30000 Hr
CRI:
70
WORKING TIME:
-30°C + 60°C
POWER FACTOR:
0.9
IK:
10

REF	W	SIZE	COLOR	°K
LM6240	100	360X205HX120 mm	Gris / Gray	5000K
LM6241	100	360X205HX120 mm	Gris / Gray	4000K
LM6242	150	360X270HX120 mm	Gris / Gray	5000K
LM6243	150	360X270HX120 mm	Gris / Gray	4000K
LM6244	200	360X360HX120 mm	Gris / Gray	5000K
LM6245	200	360X360HX120 mm	Gris / Gray	4000K
LM6246	250	360X460HX120 mm	Gris / Gray	5000K
LM6247	250	360X460HX120 mm	Gris / Gray	4000K



Illuminación Exterior / Proyector Lineales LED

Wall Washer Foss



IP:
IP65
POWER SUPPLY:
24V
ANGLE:
30°
MATERIAL:
Aluminium
BRIGHTNESS:
1600
LIGHT SOURCE:
Epistar
DURABILITY:
30000 Hr
CRI:
85

REF	W	SIZE	COLOR	°K
LM6601	18	1010X41X30H mm	Gris / Gray	6000K
LM6602	18	1010X41X30H mm	Gris / Gray	4500K
LM6603	18	1010X41X30H mm	Gris / Gray	3000K



Wall Washer Foss 18W

El **Wall Washer Foss** es un versátil proyector de iluminación diseñado para resaltar y realzar la belleza arquitectónica de fachadas y espacios exteriores. Con características avanzadas y múltiples opciones de temperatura de COLOR, este producto se adapta a diversas necesidades de iluminación. A continuación, detallamos sus principales características:

Potencia de 18 vatios: Con 18W de potencia, el **Wall Washer Foss** ofrece una iluminación efectiva para destacar fachadas y detalles arquitectónicos con eficiencia energética.

Fuente luminica Epistar: Equipado con componentes de alta calidad de Epistar, garantiza un rendimiento confiable y una fuente de luz duradera.

1800 lúmenes: Genera un flujo luminoso significativo para resaltar superficies y elementos arquitectónicos de manera efectiva.

Angulo de haz de 30 grados: El ángulo de 30 grados permite una dispersión de luz precisa y enfocada, ideal para iluminar fachadas y acentuar detalles.

Vida útil de 30,000 horas: Con una larga vida útil, este **Wall Washer** minimiza los costos de mantenimiento y garantiza un rendimiento **duradero**.

Protección IP65: Cuenta con una clasificación **IP65**, lo que significa que está protegido contra la entrada de polvo y chorros de agua, lo que lo hace apto para uso en exteriores, donde puede estar expuesto a condiciones climáticas adversas.

CRI de 85: Ofrece una reproducción precisa de los Colores, lo que es fundamental para resaltar la belleza de la arquitectura y los detalles.

Temperatura de COLOR: El **Wall Washer Foss** proporciona tres opciones de temperatura de COLOR: **6000K (luz blanca y fría)**, **4500K (luz blanca neutra)** y **3000K (luz blanca cálida)**. Esto permite adaptar la iluminación a las preferencias estéticas y funcionales de cada aplicación.

Iluminación de fachadas: Diseñado específicamente para la iluminación de fachadas, este **Wall Washer** es una solución versátil para destacar y embellecer edificios y estructuras exteriores, proporcionando un aspecto distintivo y profesional.

El **Wall Washer Foss** es una elección confiable y eficiente para proyectos de iluminación arquitectónica, ya que combina una vida útil duradera con un rendimiento de calidad y opciones de personalización en cuanto a la temperatura de COLOR.

The Foss Wall Washer is a versatile lighting projector designed to highlight and enhance the architectural beauty of facades and outdoor spaces. With advanced features and multiple color temperature options, this product adapts to various lighting needs. Below, we detail its main features:

18-watt Power: With 18W of power, the **Foss Wall Washer** offers effective illumination to highlight facades and architectural details with energy efficiency.

Epistar light source: Equipped with high-quality **Epistar** components, it ensures reliable performance and a durable light source.

Brightness of 1800 lumens: Generates a significant luminous flux to effectively highlight surfaces and architectural elements.

30-degree Beam angle: The **30-degree** angle allows for precise and focused light dispersion, ideal for illuminating facades and accentuating details.

30,000-hour DURABILITY: With long durability, this **Wall Washer** minimizes maintenance costs and ensures long-lasting performance.

IP65 Protection: It has an IP65 rating, meaning it is protected against dust ingress and water jets, making it suitable for outdoor use, where it may be exposed to adverse weather conditions.

CRI of 85: Offers accurate color reproduction, which is crucial for highlighting the beauty of architecture and details.

COLOR Temperature Options: The **Foss Wall Washer** provides three color temperature options: **6000K (cool white light)**, **4500K (neutral white light)**, and **3000K (warm white light)**. This allows for adapting the lighting to the aesthetic and functional preferences of each application.

Facade Lighting: Specifically designed for facade lighting, this **Wall Washer** is a versatile solution for highlighting and beautifying buildings and outdoor structures, providing a distinctive and professional look.

The **Foss Wall Washer** is a reliable and efficient choice for architectural lighting projects, combining durable durability with quality performance and customization options regarding color temperature.

Floodlight Led Infinity



IP:
IP65
BRIGHTNESS:
120 LM/W
WORKING TIME:
-40°C + 65°C
ANGLE:
145°X70°
DURABILITY:
40000 Hr
IK:
8
CRI:
70
KV:
6 Kv
POWER SUPPLY:
100-240V AC
MATERIAL:
Aluminium / Cristal
POWER FACTOR:
0.9
DIMMABLE:
1-10V

REF	W	SIZE	COLOR	°K
LM6460	60	218X46X285H mm	Gris / Gray	6000K
LM6461	100	235X48X315H mm	Gris / Gray	6000K
LM6462	150	255X49X386H mm	Gris / Gray	6000K
LM6465	150	255X49X386H mm	Gris / Gray	4000K
LM6466	150	255X49X386H mm	Gris / Gray	3000K



Compatible accessories:



LM6652
Articulated Arm



LF-SCD010B
1-10V 2-Wire to DALI
IP67 Converter Gateway



1. Quitar los tapones para proceder a la colocación del brazo articulado.

1. Remove the plugs to proceed with the installation of the articulated arm.



2. Quitar la sujeción del foco.

2. Remove the fixture clamp.



3. Colocar el brazo articulado y atornillarlo coincidiendo en sus orificios.

3. Place the articulated arm and screw it into place, aligning it with its holes.



4. El foco esta listo para la instalación en poste para usarlo como farola.



REF	W	ANGLE	SIZE	COLOR	*K
LM6212	500	60°	550HX400X110 mm	Negro / Black	6000K
LM6214	750	25°	710HX400X110 mm	Negro / Black	6000K
LM6216	1000	25°	930HX436X145 mm	Negro / Black	6000K



Compatible accessories:



LF-SCD010B
1-10V 2-Wire to DALI IP67
Converter Gateway

SPECIFICATIONS

- MATERIAL**
Aluminium
- BRIGHTNESS**
150 LM/W
- LIGHT SOURCE**
Lumileds
- DURABILITY**
50000 HR
- OVERVOLTAGE PROTECTION**
6 KV
- POWER SUPPLY**
100-240V AC
- DRIVER**
INVERTRONICS
- CRI**
75
- POWER FACTOR**
0.95
- REGULABLE**
1-10V
- IP**
IP65
- WORKING TEMPERATURE**
-30°C + 50°C
- IK**
8



FLOODLIGHT LED STADIUM

500W / 750W / 1000W

Los focos modulares LED Stadium se han convertido en una opción cada vez más popular para iluminar de manera eficiente y efectiva los espacios deportivos. Uno de los modelos más destacados es el **Foco Modular LED Stadium**, el cual ofrece una serie de características que lo hacen una elección ideal para este tipo de instalaciones.

Con una eficiencia de **150 LM/W**, el **Foco Modular LED Stadium** proporciona una iluminación potente y brillante, asegurando una visibilidad óptima en todo el estadio. Además, su ángulo de apertura de **60°** y de **25°** permite una distribución uniforme de la luz, evitando sombras y garantizando una experiencia visual óptima para los espectadores.

La protección **IP65** del **Foco Modular LED Stadium** lo hace resistente al polvo y a la humedad, lo que lo convierte en una opción perfecta para su uso en exteriores.

The modular LED Stadium floodlights have become an increasingly popular choice for efficiently and effectively illuminating sports spaces. One of the standout models is the **Modular LED Stadium Floodlight**, which offers a series of features that make it an ideal choice for such installations.

With an efficiency of **150 LM/W**, the **Modular LED Stadium Floodlight** provides powerful and bright illumination, ensuring optimal visibility throughout the stadium. Additionally, its **60°** and **25°** beam angle allows for even light distribution, avoiding shadows and ensuring an optimal visual experience for spectators.

The **IP65** protection of the **Modular LED Stadium Floodlight** makes it resistant to dust and moisture, making it a perfect option for outdoor use.

REF	W	SIZE	COLOR	*K
LM6480	400	495X370X140 mm	Gris / Gray	5000K
LM6483	400	495X370X140 mm	Gris / Gray	4000K
LM6484	400	495X370X140 mm	Gris / Gray	3000K
LM6481	500	495X440X140 mm	Gris / Gray	5700K
LM6485	500	495X440X140 mm	Gris / Gray	4000K
LM6482	600	495X540X140 mm	Gris / Gray	6000K

Compatible accessories:



LF-SCD010B
1-10V 2-Wire to DALI
IP67 Converter Gateway



SPECIFICATIONS

- ANGLE**
60°
- MATERIAL**
Aluminium/PMMA
- BRIGHTNESS**
125 LM/W
- LIGHT SOURCE**
Lumileds
- DURABILITY**
50000 HR
- OVERVOLTAGE PROTECTION**
6 KV
- POWER SUPPLY**
90-265V AC
- DRIVER**
INVERTRONICS
- CRI**
70
- POWER FACTOR**
0.90
- REGULABLE**
1-10V
- IP**
IP65
- WORKING TEMPERATURE**
-40°C + 65°C

FLOODLIGHT LED COLISEUM

400W / 500W / 600W



El Foco Modular LED Coliseum es una solución innovadora y eficiente para iluminar estadios y espacios deportivos de gran envergadura. Con una potencia luminica de 125 LM/W, este foco modular proporciona una iluminación de calidad y alto rendimiento.

Una de las características destacadas de este foco es su ángulo de apertura de **60°**, lo que permite una distribución uniforme de la luz en el área deseada. Esto resulta especialmente importante en estadios, donde se requiere una iluminación óptima para garantizar la visibilidad de los jugadores y espectadores.

Además, el **Foco Modular LED Coliseum** cuenta con una protección **IP65**, lo que lo hace resistente al polvo y a la humedad. Esto garantiza su durabilidad y su capacidad para soportar las condiciones climáticas más adversas.

The Coliseum Modular LED floodlight is an innovative and efficient solution for lighting stadiums and large-scale sports venues. With a light output of 125 LM/W, this modular floodlight provides high quality and high performance lighting.

One of the outstanding features of this floodlight is its **60°** angle of aperture, which allows the light to be evenly distributed over the desired area. This is especially important in stadiums, where optimum illumination is required to ensure visibility for players and spectators.

In addition, the **Coliseum Modular LED Floodlight** is **IP65** protected, making it dust and moisture resistant. This guarantees its durability and its ability to withstand the most adverse weather conditions.

REF	W	SIZE	COLOR	°K
LM6201	250	397X114X237H mm	Gris / Gray	6000K

Compatible accessories:



LF-SCD010B
1-10V 2-Wire to DALI IP67
Converter Gateway

SPECIFICATIONS
ANGLE 60°
MATERIAL Aluminium
BRIGHTNESS 375000
LIGHT SOURCE Lumileds
DURABILITY 30000 HR
OVERVOLTAGE PROTECTION 4 KV
POWER SUPPLY 170-240V AC
DRIVER INVERTRONICS
CRI 70
POWER FACTOR 0.95
REGULABLE 1-10V
IP IP65
WORKING TEMPERATURE -30°C + 50°C



FLOODLIGHT LED COLISEO 250W



El Foco Modular LED Coliseo de 250W es una solución de iluminación de alto rendimiento que brinda una luminosidad excepcional en una amplia variedad de aplicaciones.

Fuente de luz: Equipado con componentes de alta calidad de **Lumileds**, garantiza una fuente de luz confiable y duradera.

37.500 LM: Genera un flujo luminoso impresionante, lo que lo hace ideal para áreas que requieren una iluminación intensa.

Angulo: Dispersión de luz óptima para diversas aplicaciones.

Protección IP65: Adecuado para uso en exteriores.

IK8: Resistente a impactos y golpes, lo que lo hace adecuado para entornos exigentes.

4KV: Resiste sobretensiones de hasta **4Kv**, lo que garantiza una mayor durabilidad y protección contra problemas eléctricos.

DRIVER: Equipado con un **driver de alta calidad de Inventronics** para un rendimiento fiable y eficiencia energética.

CRI 70: Ofrece una reproducción precisa de los Colores, lo que es importante en aplicaciones donde la calidad de la luz es crucial.

Factor de potencia de 0.95: Este foco modular utiliza eficientemente la energía y reduce los costos.

Regulable 1-10V: La capacidad de regulación permite adaptar la intensidad de la luz a las necesidades.

Garantía de 5 años: Tiene la tranquilidad de contar con un producto de calidad respaldado por el fabricante.

The 250W Coliseum Modular LED Floodlight is a high-performance lighting solution that provides exceptional brightness in a wide variety of applications.

LIGHT SOURCE: Equipped with high-quality Lumileds components, it ensures a reliable and durable light source.

37,500 LM: Generates impressive luminous flux, making it ideal for areas requiring intense illumination.

ANGLE: Optimal light dispersion for various applications.

IP65 Protection: Suitable for outdoor use.

IK8: Resistant to impacts and shocks, making it suitable for demanding environments.

4KV: Withstands surges of up to 4Kv, ensuring greater durability and protection against electrical issues.

DRIVER: Equipped with a high-quality Inventronics driver for reliable performance and energy efficiency.

CRI 70: Offers accurate color reproduction, which is important in applications where light quality is crucial.

0.95 POWER FACTOR: This modular floodlight efficiently utilizes energy and reduces costs.

Dimmable 1-10V: Dimming capability allows for adjusting light intensity to meet needs.

5-Year Warranty: Have peace of mind with a quality product backed by the manufacturer.



SPECIFICATIONS

- ANGLE**
60°
- MATERIAL**
Aluminium/PMMA
- BRIGHTNESS**
125 LM/W
- LIGHT SOURCE**
Lumileds
- DURABILITY**
50000 HR
- OVERVOLTAGE PROTECTION**
6 KV
- POWER SUPPLY**
90-265V AC
- DRIVER**
INVERTRONICS
- CRI**
70
- POWER FACTOR**
0.90
- REGULABLE**
1-10V
IP
- WORKING TEMPERATURE**
-40°C + 65°C
IK
8

Compatible accessories:



LF-SCD010B
1-10V 2-Wire to DALI IP67 Converter Gateway

FLOODLIGHT LED PLANET

400W / 600W



REF	W	SIZE	COLOR	°K
LM6470	400	483X445X320 mm	Negro / Black	6000K
LM6471	400	483X445X320 mm	Negro / Black	4500K
LM6472	600	581X537X373 mm	Negro / Black	6000K
LM6473	600	581X537X373 mm	Negro / Black	4500K

Descubre el Foco Proyector LED Planet, con características de vanguardia y un rendimiento superior es la elección ideal.

LUMILEDS: Luz de calidad superior, brillante y uniforme.
125 LM/W: Rendimiento excepcional.
-40°C / +65°C: Resistente a condiciones extremas asegurando un rendimiento estable en diversas condiciones climáticas.
Angulo 60°: Este proyector proporciona una cobertura amplia y versátil, adaptándose a una variedad de aplicaciones.
Vida útil 50.000 Hr: Reduce la necesidad de reemplazos frecuentes, ofreciendo una solución duradera.
Protección: Con clasificación **IP65** y resistencia **IK8**, este foco proyector está diseñado para resistir condiciones adversas.
6KV: Seguridad y durabilidad garantizada.
Alimentación: Desde **90V** hasta **265V AC**, este proyector se adapta fácilmente a diferentes configuraciones eléctricas.
INVERTRONICS: Driver **INVERTRONICS**, este foco proyector garantiza un control preciso y eficiente de la iluminación.
CRI 70: Reproducción de color natural y fiel, ideal para aplicaciones donde la precisión del color es crucial.
Factor de potencia: Factor de potencia de **0.90**, contribuye a la eficiencia energética y ayuda a minimizar la pérdida de energía.

Discover the Planet LED Floodlight, featuring cutting-edge characteristics and superior performance.

LUMILEDS: Superior quality, bright, and uniform light.
125 LM/W: Exceptional performance.
-40°C / +65°C: Resistant to extreme conditions, ensuring stable performance in various weather conditions.
60° angle: This floodlight provides wide and versatile coverage, adapting to a variety of applications.
50,000 Hr Lifespan: Reduces the need for frequent replacements, offering a long-lasting solution.
Protection: With IP65 rating and IK8 resistance, this floodlight is designed to withstand adverse conditions.
6KV: Guaranteed safety and durability.
POWER SUPPLY: From **90V** to **265V AC**, this floodlight easily adapts to different electrical configurations.
INVERTRONICS: Equipped with **INVERTRONICS** driver, this floodlight ensures precise and efficient lighting control.
CRI 70: Natural and faithful color reproduction, ideal for applications where color accuracy is crucial.
POWER FACTOR: **0.90** power factor contributes to energy efficiency and helps minimize energy loss.



Wall Sconce Led Fit 10W



IP:
IP54
BRIGHTNESS:
920 LM
WORKING TIME:
-20°C + 45°C
ANGLE:
180°
DURABILITY:
30000 Hr
IK:
8
CRI:
70
POWER SUPPLY:
100-240V AC
MATERIAL:
Aluminium / PC

REF	W	SIZE	COLOR	°K
LM6158	10	120X80X245H mm	Negro / Black	3000K



Wall Sconce Led Metse 10W



IP:
IP57
BRIGHTNESS:
920 LM
WORKING TIME:
-20°C + 45°C
ANGLE:
180°
DURABILITY:
30000 Hr
IK:
8
CRI:
70
POWER SUPPLY:
100-240V AC
MATERIAL:
Aluminium / PC

REF	W	SIZE	COLOR	°K
LM6157	10	120X80X245H mm	Negro / Black	3000K



Wall Sconce Led Dakota 12W



IP:
IP54
BRIGHTNESS:
1160
WORKING TIME:
-20°C + 45°C
ANGLE:
180°
DURABILITY:
30000 Hr
IK:
8
CRI:
80
POWER SUPPLY:
100-240V AC
MATERIAL:
Aluminium / PC

REF	W	SIZE	COLOR	°K
LM6159	12	190X145X160H mm	Negro / Black	3000K



Wall Sconce Led Globe 10W



IP:
IP54
BRIGHTNESS:
920
WORKING TIME:
-20°C + 45°C
ANGLE:
180°
DURABILITY:
30000 Hr
IK:
8
CRI:
80
POWER SUPPLY:
100-240V AC
MATERIAL:
Aluminium / PC

REF	W	SIZE	COLOR	°K
LM6151	10	122X80X150H mm	Negro / Black	3000K



Wall Sconce Led Mirror 10W



IP:
IP54
BRIGHTNESS:
920 LM
WORKING TIME:
-20°C + 45°C
ANGLE:
180°
DURABILITY:
30000 Hr
IK:
8
CRI:
80
POWER SUPPLY:
100-240V AC
MATERIAL:
Aluminium / PC

REF	W	SIZE	COLOR	°K
LM6161	10	140X140X180H mm	Negro / Black	3000K



Wall Sconce Led Arrow 10W



IP:
IP54
BRIGHTNESS:
920 LM
WORKING TIME:
-20°C + 45°C
ANGLE:
180°
DURABILITY:
30000 Hr
IK:
8
CRI:
80
POWER SUPPLY:
100-240V AC
MATERIAL:
Aluminium / PC

REF	W	SIZE	COLOR	°K
LM6163	10	135X100X85H mm	Negro / Black	3000K



Wall Sconce Led World 10W



IP:
IP54
BRIGHTNESS:
920 LM
WORKING TIME:
-20°C + 45°C
ANGLE:
180°
DURABILITY:
30000 Hr
IK:
8
CRI:
80
POWER SUPPLY:
100-240V AC
MATERIAL:
Aluminium / PC

REF	W	SIZE	COLOR	°K
LM6162	10	135X105X105H mm	Negro / Black	3000K



Wall Sconce Led Hubb 10W



IP:
IP54
BRIGHTNESS:
920 LM
WORKING TIME:
-20°C + 45°C
ANGLE:
180°
DURABILITY:
30000 Hr
IK:
8
CRI:
80
POWER SUPPLY:
100-240V AC
MATERIAL:
Aluminium / PC

REF	W	SIZE	COLOR	°K
LM6160	10	140X140X180H mm	Negro / Black	3000K



Wall Sconce Led Nian 10W



IP:
IP54
BRIGHTNESS:
920 LM
WORKING TIME:
-20°C + 45°C
ANGLE:
180°
DURABILITY:
30000 Hr
IK:
8
CRI:
70
POWER SUPPLY:
100-240V AC
MATERIAL:
Aluminium / PC

REF	W	SIZE	COLOR	°K
LM6153	10	175X35X90H mm	Negro / Black	3000K



Wall Sconce Led Fine 10W



IP:
IP54
BRIGHTNESS:
920 LM
WORKING TIME:
-20°C + 45°C
ANGLE:
160°
DURABILITY:
30000 Hr
IK:
8
CRI:
80
POWER SUPPLY:
100-240V AC
MATERIAL:
Aluminium / PC

REF	W	SIZE	COLOR	°K
LM6150	10	175X28X90H mm	Negro / Black	3000K



Wall Sconce Led Lounge 10W



IP:
IP54
BRIGHTNESS:
920 LM
WORKING TIME:
-20°C + 45°C
ANGLE:
60°
DURABILITY:
30000 Hr
IK:
8
CRI:
80
POWER SUPPLY:
100-240V AC
MATERIAL:
Aluminium / PC

REF	W	SIZE	COLOR	°K
LM6156	10	67X50X180H mm	Negro / Black	3000K



Wall Sconce Led Falcon 6W



IP:
IP54
BRIGHTNESS:
520 LM
WORKING TIME:
-20°C + 45°C
ANGLE:
60°
DURABILITY:
30000 Hr
IK:
8
CRI:
80
POWER SUPPLY:
100-240V AC
MATERIAL:
Aluminium / PC

REF	W	SIZE	COLOR	°K
LM6155	10	60X35X120H mm	Negro / Black	3000K



Wall Sconce Led Ian 10W



IP:
IP54
BRIGHTNESS:
920 LM
WORKING TIME:
-20°C + 45°C
ANGLE:
160°
DURABILITY:
30000 Hr
IK:
8
CRI:
80
POWER SUPPLY:
100-240V AC
MATERIAL:
Aluminium / PC

REF	W	SIZE	COLOR	°K
LM6152	6	110X90X130H mm	Negro / Black	3000K



Wall Sconce Led Vera 6W



IP:
IP54
BRIGHTNESS:
520 LM
WORKING TIME:
-20°C + 45°C
ANGLE:
160°
DURABILITY:
30000 Hr
IK:
8
CRI:
80
POWER SUPPLY:
100-240V AC
MATERIAL:
Aluminium / PC

REF	W	SIZE	COLOR	°K
LM6154	6	105X50X121H mm	Negro / Black-Dorado / Gold	3000K



LED Flush Mount Round Nature 24-18-15-12W Ip65



IP:
IP65
BRIGHTNESS:
2400-1800-1500-1200
WORKING TIME:
-20°C + 45°C
ANGLE:
120°
DURABILITY:
30000 Hr
IK:
8
CRI:
80
POWER SUPPLY:
175-240V AC
MATERIAL:
Aluminium / PC

REF	W	SIZE	COLOR	°K
LM6235	24-18-15-12	280X55H mm	Blanco / White	CCT



LED Surface Beacon Wall Long Rectangular 5W



IP:
IP54
BRIGHTNESS:
400
WORKING TIME:
-20°C + 45°C
ANGLE:
120°
DURABILITY:
30000 Hr
IK:
8
CRI:
80
POWER SUPPLY:
85-265V AC
MATERIAL:
Aluminium / PC

REF	W	SIZE	COLOR	°K
LM6101	5	230X80X27H mm	Negro / Black	4000 K
LM6102	5	230X80X27H mm	Negro / Black	3000 K
LM6103	5	230X80X27H mm	Blanco / White	4000 K
LM6104	5	230X80X27H mm	Blanco / White	3000 K



							
118. Solar LED Wall Light Venus with Motion Sensor	118. Solar LED Wall Light Mustang with Motion Sensor	118. Aplique LED Solar Venus con Sensor Movimiento	118. Solar LED Wall Light Venus with Motion Sensor	119. Solar LED Wall Light Mus with Motion Sensor	119. Solar LED Wall Light Moon with Motion Sensor	119. Solar LED Wall Light Sun with Motion Sensor	119. Solar LED Wall Light Star
							
120. Baliza LED solar Buy de suelo con pincho	121. Solar LED Wall Light Vienna Series	122. Solar LED Garland 3W with 10 E27 Bulbs Outdoor IP65	122. Solar LED Wall Light Jano	122. Solar LED Wall Light Cory	122. Solar LED SphereGlass Vintage exterior	123. Solar Lighting The Great Solution for Your Garden	124. Solar LED Strip Pack SMD2835 300L - 5 Meters
							
124. Solar LED Strip Pack SMD2835 300L - 5 Meters	126. Solar LED Spotlight with Owl Stake	126. Solar Truck Beacon	127. Solar LED Floodlight with Power Bank Battery	128. Solar LED Floodlight with Jeff Camera	130. Solar LED Floodlight MILAN		



Alumbrado Solar



Solar
Lighting

Solar LED Wall Light Venus with Motion Sensor



IP:
IP65
ANGLE:
120°
MATERIAL:
PC
BRIGHTNESS:
200
DURABILITY:
30000 Hr
CRI:
80
SENSOR:
Crepuscular/Movimiento
CHARGE TIME:
6-8 Hr
USE TIME:
4-6 Hr

REF	W	SIZE	COLOR	°K	Pack
LM6430	4	138X97HX58 mm	Negro / Black	6000K	4
LM6429	4	138X97HX58 mm	Negro / Black	6000K	2



Solar LED Wall Light Mustang with Motion Sensor



IP:
IP44
ANGLE:
120°
MATERIAL:
PC
BRIGHTNESS:
450
DURABILITY:
30000 Hr
SENSOR:
Crepuscular/Movimiento
CHARGE TIME:
3-4 Hr
USE TIME:
4-6 Hr

REF	W	SIZE	COLOR	°K
LM6437	10	130X95X50 mm	Negro / Black	4500K



Aplicador LED Solar Venus con Sensor Movimiento



IP:
IP44
ANGLE:
120°
MATERIAL:
PC
BRIGHTNESS:
300
DURABILITY:
30000 Hr
SENSOR:
Crepuscular/Movimiento
CHARGE TIME:
3-4 Hr
USE TIME:
4-6 Hr

REF	W	SIZE	COLOR	°K
LM6436	6	200X105X45 mm	Negro / Black	4500K



Solar LED Wall Light Venus with Motion Sensor



IP:
IP44
ANGLE:
120°
MATERIAL:
PC
BRIGHTNESS:
500
DURABILITY:
30000 Hr
SENSOR:
Crepuscular/Movimiento
CHARGE TIME:
3-4 Hr
USE TIME:
4-6 Hr

REF	W	SIZE	COLOR	°K
LM6435	12	300X105X48 mm	Negro / Black	4500K



Solar LED Wall Light Mus with Motion Sensor



IP:
IP44
ANGLE:
120°
MATERIAL:
PC
BRIGHTNESS:
150
DURABILITY:
30000 Hr
SENSOR:
Crepuscular/Movimiento
CHARGE TIME:
3-4 Hr
USE TIME:
4-6 Hr

REF	W	SIZE	COLOR	°K
LM6434	3	120X55X100 mm	Negro / Black	4500K



Solar LED Wall Light Moon with Motion Sensor



IP:
IP44
ANGLE:
120°
MATERIAL:
PC
BRIGHTNESS:
150
DURABILITY:
30000 Hr
SENSOR:
Crepuscular/Movimiento
CHARGE TIME:
3-4 Hr
USE TIME:
4-6 Hr

REF	W	SIZE	COLOR	°K
LM6433	3	100X110X40 mm	Negro / Black	4500K



Solar LED Wall Light Sun with Motion Sensor



IP:
IP44
ANGLE:
120°
MATERIAL:
PC
BRIGHTNESS:
200
DURABILITY:
30000 Hr
SENSOR:
Crepuscular/Movimiento
CHARGE TIME:
3-4 Hr
USE TIME:
4-6 Hr

REF	W	SIZE	COLOR	°K
LM6432	4	170X120X40 mm	Negro / Black	4500K



Solar LED Wall Light Star



IP:
IP44
ANGLE:
120°
MATERIAL:
PC
BRIGHTNESS:
150
DURABILITY:
30000 Hr
SENSOR:
Crepuscular
CHARGE TIME:
3-4 Hr
USE TIME:
4-6 Hr

REF	W	SIZE	COLOR	°K
LM6431	3	112X48 mm	Aluminio / Aluminium	4500K



BALIZA LED SOLAR BUY DE SUELO CON PINCHO

ANGLE
330°

MATERIAL
PC

BRIGHTNESS
90

DURABILITY
30000 HR

BATTERY
3.7V 800 MAH

SENSOR
CREPUSCULAR

CHARGE TIME
5-6 HR

USE TIME
6-8 HR

IP
66



REF	W	SIZE	COLOR	*K
LM7304	3	121X121X24 mm	Negro / Black	3000K

3 YEARS
OF WARRANTY



Incluye
Pincho

IP:
 IP54
ANGLE:
 60°
MATERIAL:
 PC
BRIGHTNESS:
 100 LM/W
LIGHT SOURCE:
 Smd 3030
DURABILITY:
 30000 Hr
CRI:
 70
CHARGE TIME:
 5-6 Horas
USE TIME:
 6-8 Horas
SENSOR:
 Sensor Crepuscular

REF	W	Bateria	SIZE	COLOR	°K
LM7371	2	3.2V 1800 mAh	160X130X28 mm	Negro / Black	CCT
LM7372	4,5	3.2V 3800 mAh	350X141X28 mm	Negro / Black	CCT
LM7373	10	3.2V 5700 mAh	350X266X28 mm	Negro / Black	CCT



Includes
Swift CCT

SOLAR LED WALL LIGHT VIENNA SERIES

La **Serie Aplique Led Solar Viena** es una opción moderna y eficiente para iluminar cualquier espacio exterior. Con una Brightness de **100 LM/W**, esta serie de apliques ofrece una iluminación potente y de calidad, perfecta para resaltar detalles arquitectónicos o simplemente para brindar una mayor seguridad en el entorno.

Una de las características destacadas de la **Serie Aplique Led Solar Viena** es su protección **IP54**, lo que la convierte en una opción resistente al polvo y al agua. Esto significa que puede soportar condiciones climáticas adversas sin perder su funcionalidad ni su estética.

La fuente luminica **smd 3030** utilizada en estos apliques garantiza una iluminación uniforme y de alta calidad. Gracias a esta tecnología, se obtiene un mayor rendimiento lumínico y una mayor eficiencia energética.

The **Solar LED Wall Light Vienna Series** is a modern and efficient option for illuminating any outdoor space. With a brightness of **100 LM/W**, this series of wall lights offers powerful and quality illumination, perfect for highlighting architectural details or simply providing greater security in the surroundings.

One of the standout features of the **Solar LED Wall Light Vienna Series** is its **IP54** protection, making it resistant to dust and water. This means it can withstand adverse weather conditions without losing its functionality or aesthetics.

The **SMD 3030 light** source used in these wall lights ensures uniform and high-quality illumination. Thanks to this technology, higher luminous efficiency and greater energy efficiency are achieved.



Solar LED Garland 3W with 10 E27 Bulbs Outdoor IP65



IP:
IP65
ANGLE:
36°
MATERIAL:
PC
BRIGHTNESS:
10 lm for bulb
DIMMABLE:
SI

REF	W	SIZE	COLOR	°K
LM8958	3	7500 mm	Negro / Black	3000K
LM8959	3	7500 mm	Negro / Black	RGB



Solar LED Wall Light Jano



IP:
IP65
ANGLE:
36°
MATERIAL:
Aluminio
BRIGHTNESS:
150
LIGHT SOURCE:
Lumileds
DURABILITY:
30000 Hr
CRI:
80

REF	W	SIZE	COLOR	°K
LM6439	1	105X155X113H mm	Blanco / White	4500K



Solar LED Wall Light Cory



IP:
IP65
ANGLE:
36°
MATERIAL:
Aluminio
BRIGHTNESS:
150
LIGHT SOURCE:
Lumileds
DURABILITY:
30000 Hr
CRI:
80

REF	W	SIZE	COLOR	°K
LM6438	1	105X155X113H mm	Blanco / White	4500K



Solar LED SphereGlass Vintage exterior



IP:
IP40
MATERIAL:
Cristal
CHARGE TIME:
2-3 Hr
USE TIME:
2-3 Hr
SENSOR:
Crepuscular

REF	SIZE	°K
LM8073	125X125X145H mm	RGB
LM8074	125X125X145H mm	3000K



Kit de 4 Focos Solares LED con Pincho Roxi

Solar Lighting The Great Solution for Your Garden

REF	W	SIZE	COLOR	°K
LM7374	5	204X167X4 mm	Black	3000K



IP:
IP65
ANGLE:
60°
MATERIAL:
PC
BRIGHTNESS:
100
LIGHT SOURCE:
Smd 3030
DURABILITY:
30000 Hr
CRI:
70



Solar LED Strip Pack SMD2835 300L - 5 Meters



IP:
IP68
ANGLE:
120°
WAVELENGTH:
R-620-630
G510-525
B455-470 nm
LIGHT SOURCE:
2835
DURABILITY:
30000 Hr
CRI:
70
DIMMABLE:
Si
MATERIAL:
PC

REF	W	SIZE	COLOR	°K
LM2425	4	10X5000 mm	PCB Blanco / White	Multicolor



Included
Remote control



Solar LED Strip Pack SMD2835 300L - 5 Meters



IP:
IP68
ANGLE:
120°
BRIGHTNESS:
600
MATERIAL:
PC
LIGHT SOURCE:
2835
DURABILITY:
30000 Hr
CRI:
70
DIMMABLE:
Si

REF	W	SIZE	COLOR	°K
LM2424	4	10X5000 mm	PCB Blanco / White	3000K



Included
Remote control





Solar LED Spotlight with Owl Stake



IP:
IP65
ANGLE:
60°
MATERIAL:
PC
BRIGHTNESS:
150
LIGHT SOURCE:
Smd 3030
DURABILITY:
30000 Hr
CRI:
70

REF	W	SIZE	COLOR	°K
LM7376	1,5	104X60,5X168,5 mm	Negro / Black	3000K



Solar Truck Beacon

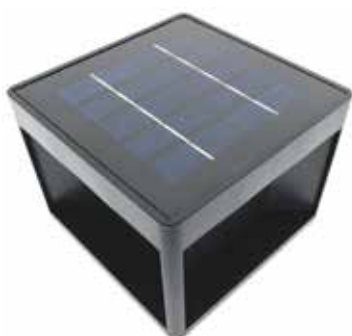

IP:
IP65
ANGLE:
60°
MATERIAL:
PC
BRIGHTNESS:
160
LIGHT SOURCE:
Smd 3030
DURABILITY:
30000 Hr
CRI:
70

REF	W	SIZE	COLOR	°K
LM7375	1,6	150X150X125 mm	Negro / Black	CCT



SOLAR LED FLOODLIGHT WITH POWER BANK BATTERY



SPECIFICATIONS

- ANGLE**
120°
- MATERIAL**
ABS
- BRIGHTNESS**
90 LM/W
- LIGHT SOURCE**
SMD 2835
- DURABILITY**
50000 HR
- CHARGE TIME**
8 HR
- USE TIME**
8-36 HR
- POWER SUPPLY**
5V DC

REF	W	Batería	SIZE	COLOR	°K
LM6335	50	5V 8000 mAh	205X146X60H mm	Black / Yellow	6000K
LM6336	30	5V 5000 mAh	175X146X60H mm	Black / Yellow	6000K



REF	W	Brightness	SIZE	COLOR	
LM6591	100	1160	104X60,5X168,5 mm	Negro / Black	6000K
LM6593	200	1840	212X45X256H mm	Negro / Black	6000K
LM6595	300	2900	257X45X312H mm	Negro / Black	6000K



SOLAR LED FLOODLIGHT WITH JEFF CAMERA 100W / 200W / 300W

Ilumina tu espacio con energía solar y tecnología avanzada. El Foco Proyector Led Solar con Cámara Jeff ofrece una potencia de 300W, proporcionando 2900lm de luz fría a 6000K para un ambiente brillante.

Vigila tu entorno con la cámara integrada de alta resolución 1080P y sistema Linux. Con un alcance visual nocturno de 10 metros, garantiza seguridad las 24 horas del día. Además, cuenta con un angle de visión amplio de 120° para una cobertura completa.

Diseñado para resistir los elementos, este proyector cuenta con una clasificación IP67, haciéndolo impermeable y duradero. Su estructura de aluminio y PC asegura una vida útil de 30,000 horas, con protección IK8 contra impactos.

Controla la iluminación y la cámara de forma remota a través del receptor wifi de 2.4 GHz, ya sea con el control remoto incluido o mediante la aplicación Tuya en tu dispositivo móvil. Además, es Dimmable, permitiéndote ajustar la intensidad según tus necesidades.

Con una batería recargable de 3.2V 30000mAH, este foco proyector solar se carga en 6-8 horas y ofrece un tiempo de uso de 10-12 horas. Con sensores crepusculares y de movimiento, brinda eficiencia energética y seguridad, convirtiéndolo en la opción ideal para tu patio, jardín, camino o garaje.

Illuminate your space with solar energy and advanced technology. The Jeff Solar LED Floodlight with Camera offers a power of 300W, providing 2900lm of cool white light at 6000K for a bright environment.

Monitor your surroundings with the integrated 1080P high-resolution camera and Linux system. With a nighttime visual range of 10 meters, it ensures 24-hour security. Additionally, it features a wide 120° viewing angle for complete coverage.

Designed to withstand the elements, this floodlight has an IP67 rating, making it waterproof and durable. Its aluminum and PC structure ensures a lifespan of 30,000 hours, with IK8 protection against impacts.

Control the lighting and camera remotely via the 2.4 GHz WiFi receiver, either with the included remote control or through the Tuya app on your mobile device. Furthermore, it is dimmable, allowing you to adjust the intensity according to your needs.

With a rechargeable 3.2V 30000mAH battery, this solar floodlight charges in 6-8 hours and offers a usage time of 10-12 hours. With dusk and motion sensors, it provides energy efficiency and security, making it the ideal choice for your patio, garden, pathway, or garage.

IP: IP67
 ANGLE: 120°
 MATERIAL: PC
 LIGHT SOURCE: Smd 3030
 DURABILITY: 30000 Hr
 CRI: 80
 MEMORY: 32 G
 BATTERY: 3.2V 12000mAH
 IK: 8
 CHARGE TIME: 6-8 Hr
 USE TIME: 10-12 Hr

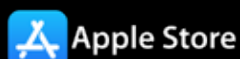

● CHARGE TIME
6-8 HR

● USE TIME 10-12 HR

● MEMORY
32 G

● CAMERA RESOLUTION
1080P

● WIFI 2.4 GHZ

● BATTERY
3.2V 12000 mAh

SOLAR LED FLOODLIGHT MILAN

50W / 100W / 200W

REF	W	BATTERY	BRIGHTNESS	SIZE	SOLAR PANEL SIZE	COLOR	°K
LM6501	50	3.2V / 5000MAH LiFePO4	750	184X157H mm	180X220H mm	Negro / Black	6000K
LM6503	100	3.2V / 10000MAH LiFePO4	1500	211X191H mm	205X310H mm	Negro / Black	6000K
LM6505	150	3.2V / 15000MAH LiFePO4	2250	256X244H mm	230X390H mm	Negro / Black	6000K
LM6507	200	3.2V / 20000MAH LiFePO4	3000	312X285H mm	300X390H mm	Negro / Black	6000K

RADAR DETECTOR ▶

ON ▶

TOTAL BRIGHT ▶

BRIGHT + ▶

RADAR ACTIVE AFTER 4 HOURS ▶

3-HOUR TIMER ▶

◀ **OFF**

◀ **BRIGHT -**

◀ **MEDIUM BRIGHT**

◀ **CONSTANT LIGHT**

◀ **5-HOUR TIMER**

◀ **8-HOUR TIMER**

130
WWW.LEDME-EUROPA.COM

SPECIFICATIONS

ANGLE
90°

MATERIAL
Aluminium/PC

LIGHT SOURCE
SMD 5050

DURABILITY
30000 HR

CHARGE TIME
10-12 HR

USE TIME
10-12 HR

POWER SUPPLY
5V DC

CRI
70

IP
IP65

WORKING TEMP
-20°C ~ + 45°C





134.
PAR56 IP68 Recessed
Pool Bulb Niche for
Concrete and Liner



135.
LED Par56 Bulb 25W
IP68



136.
Surface Mounting Frame
for Par56 Bulb Next
Series



137.
Next Series 25W IP68
RGBW LED Par56 Bulb
with Two Cables



138.
7W LED Minipool
Spotlight for Pool



139.
Two-Wire RGB+RGBW
Control Box

Focos Led
para Piscina



LED Pool
Lights

Focos Led para Piscina - LED Pool Lights

PAR56 IP68 Recessed Pool Bulb Niche for Concrete and Liner



IP:
68
MATERIAL:
PC

REF	SIZE	COLOR
LM6424	290X120H mm	Blanco / White

3 YEARS
OF WARRANTY



LED Par56 Bulb 25W IP68



BRIGHTNESS:
2000
CRI:
80
POWER SUPPLY:
12V AC/DC
ANGLE:
90°
LIGHT SOURCE:
Osram
WORKING TEMP:
0°C ~ + 55°C
DURABILITY:
30000 Hr
IP:
IP68
MATERIAL:
Aluminium / PC

REF	W	SIZE	COLOR	*K
LM6413	25	178X101H mm	Blanco / White	5000K
LM6412	25	178X101H mm	Blanco / White	3000K
LM6414	25	178X101H mm	Blanco/ White	RGBW



Focos Led para Piscina - LED Pool Lights

Surface Mounting Frame for Par56 Bulb Next Series



IP:
68
MATERIAL:
PC

REF	SIZE	COLOR
LM6416	290X120H mm	Cromo / Chrome
LM6417	290X120H mm	Blanco White



Next Series 25W IP68 RGBW LED Par56 Bulb with Two Cables



BRIGHTNESS:
2000
CRI:
80
POWER SUPPLY:
12V AC/DC
ANGLE:
90°
LIGHT SOURCE:
Osram
WORKING TEMP:
0°C ~ + 55°C
DURABILITY:
30000 Hr
IP:
IP68
MATERIAL:
Aluminium / PC

REF	W	SIZE	COLOR	*K
LM6415	25	178X101H mm	Bianco / White	RGBW



7W LED MINIPOOL SPOTLIGHT FOR POOL

REF	W	SIZE	COLOR	°K
LM6419	7	62X55H mm	Gris / Grey	5000K



SPECIFICATIONS

ANGLE
120°

MATERIAL
Aluminium/PC

LIGHT SOURCE
SMD 2835

DURABILITY
30000 HR

CHARGE TIME
10-12 HR

USE TIME
10-12 HR

POWER SUPPLY
5V DC

CRI
70

IP
IP65

WORKING TEMP
-20°C ~ + 45°C



TWO-WIRE RGB+RGBW CONTROL BOX

KEY	DESCRIPTION
ON/OFF	TURN ON/OFF
B+	BRIGHTNESS +
B-	BRIGHTNESS -
S+	SPEED +
S-	SPEED -
MODE	MODE SELECTION
R	RED
G	GREEN
B	BLUE
YE	YELLOW
CY	CYAN
PU	PURPLE
WHITE	WHITE
RGB GRADUAL	GRADUAL CHANGE RED/GREEN/BLUE
RGB JUMP	CHANGE IN JUMP RED/GREEN/BLUE
7 COLOR GRADUAL	GRADUAL CHANGE 7 COLOR
GB GRADUAL	GRADUAL CHANGE GREEN/BLUE



WIRING DIAGRAM

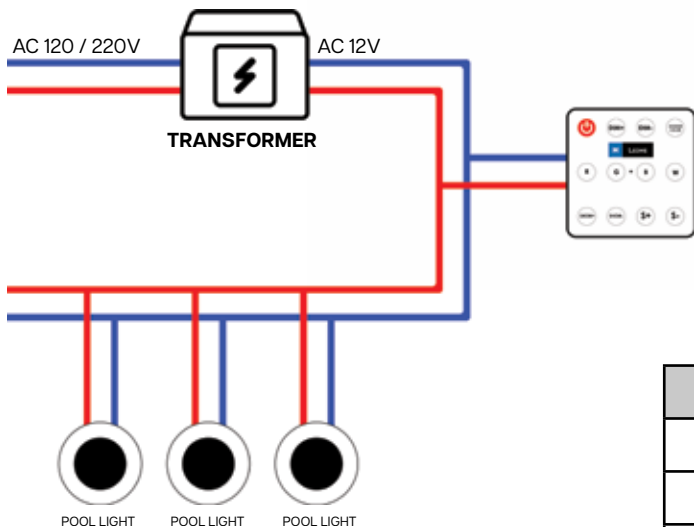

PANEL CONTROL 12 TOUCH KEYS



NO	KEY	DESCRIPTION
1		ON/OFF
2		BRIGHTNESS DIMMING + FROM DARK TO BRIGHT
3		BRIGHTNESS DIMMING - FROM DARK TO DARK
4		7 COLORS OPTIONAL
5	R	RED
6	G	GREEN
7	B	BLUE
8	W	WHITE
9		MODE SELECTION +
10		MODE SELECTION -
11	S+	SPEED +
12	S-	SPEED -

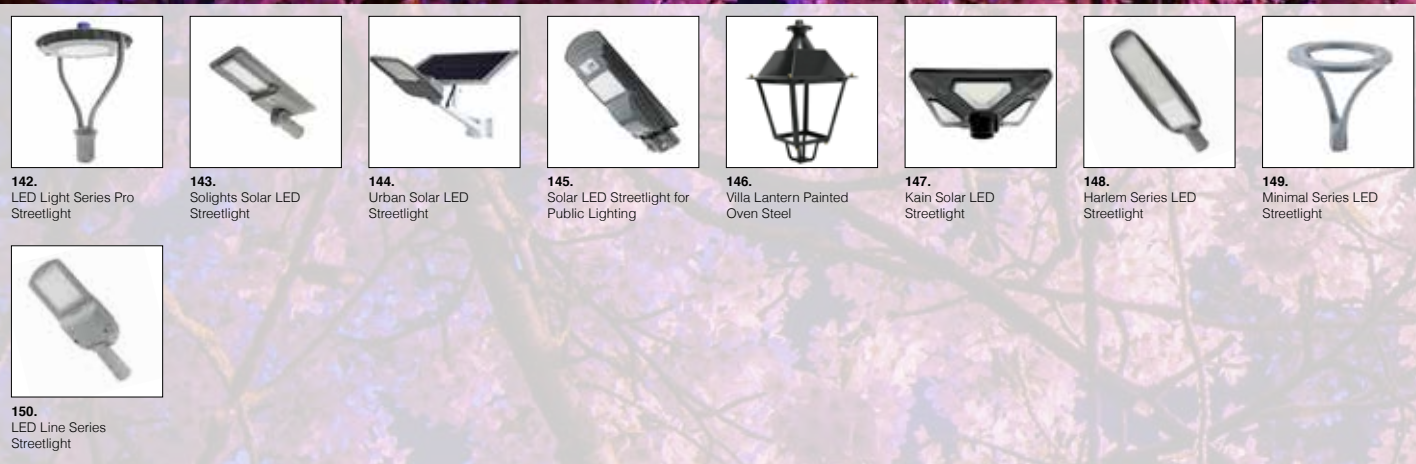

142.
LED Light Series Pro
Streetlight



143.
Solights Solar LED
Streetlight



144.
Urban Solar LED
Streetlight



145.
Solar LED Streetlight for
Public Lighting



146.
Villa Lantern Painted
Oven Steel



147.
Kain Solar LED
Streetlight



148.
Harlem Series LED
Streetlight



149.
Minimal Series LED
Streetlight



150.
LED Line Series
Streetlight

Alumbrado Público



Public
Lighting

LED Light Series Pro Streetlight



BRIGHTNESS:
4500
CRI:
70
POWER SUPPLY:
120-277V AC
ANGLE:
120°
LIGHT SOURCE:
Smd 3030
POWER FACTOR:
0,9
WORKING TEMP:
-30°C ~ + 50°C
IK:
8
Kv:
2 Kv
DURABILITY:
50000 Hr
IP:
IP65
MATERIAL:
Aluminio / Cristal
Encendido nivel luz:
10-16 Lux

REF	W	SIZE	COLOR	*K	INCLUDES
LM6450	50	466X565H mm	Gris / Grey	5000K	Fotocelula
LM6451	50	466X565H mm	Gris / grey	4500K	Fotocelula



Compatible accessories:



LM0020
Anulador de Fotocélula



**Turn-on Level
10-16 Lux**





CRI:
70
ANGLE:
140°X75°
LIGHT SOURCE:
Sanan
WORKING TEMP:
-30°C - + 60°C
IK:
8
DURABILITY:
40000 Hr
IP:
IP65
MATERIAL:
Aluminio / PMMA
TIME CHARGE:
6-8 Hr
TIME USE:
10-12 Hr
SENSOR:
Crepuscular / Movimiento
DIMMABLE:
Si

REF	W	SIZE	COLOR	Brightness	*K	Ø Fijación
LM6541	100	550X288X130 mm	Gris / Grey	1500	6000K	60 mm
LM6540	100	550X288X130 mm	Gris / Grey	1500	4000K	60 mm
LM6542	100	550X288X130 mm	Gris / Grey	1500	2700K	60 mm
LM6543	200	660X322X130 mm	Gris / Grey	2600	6000K	60 mm
LM6544	200	660X322X130 mm	Gris / Grey	2600	4000K	60 mm
LM6545	200	660X322X130 mm	Gris / Grey	2600	2700K	60 mm
LM6546	300	850X350X130 mm	Gris / Grey	3906	6000K	60 mm
LM6547	300	850X350X130 mm	Gris / Grey	3906	4000K	60 mm
LM6548	300	850X350X130 mm	Gris / Grey	3906	2700K	60 mm



Synchronizing Needs

ON: Encendido de farola
OFF: Apagado de farola
+: Aumentar intensidad
-: Reducir intensidad
AUTO: Encendido a partir de 10-16 lux al 100%, el nivel de intensidad se verá afectado según el nivel de carga de la batería.
3H: Funcionamiento al 100% durante 3 horas, pasado ese tiempo apagado total.
5H: Funcionamiento al 100% durante 5 horas, pasado ese tiempo apagado total.
8H: Funcionamiento al 100% durante 8 horas, pasado ese tiempo apagado total.
+: Aumentar intensidad
-: Reducir intensidad

ON: Streetlight On
OFF: Streetlight Off
+: Increase intensity
-: Decrease intensity
AUTO: On at 10-16 lux at 100%, intensity level will be affected by battery charge level.
3H: Operates at 100% for 3 hours, then completely off.
5H: Operates at 100% for 5 hours, then completely off.
8H: Operates at 100% for 8 hours, then completely off.
+: Increase intensity
-: Decrease intensity





CRI:
75
ANGLE:
140°X75°
LIGHT SOURCE:
Bridgelux
WORKING TEMP:
-30°C ~ + 50°C
DURABILITY:
40000 Hr
IP:
IP65
MATERIAL:
Aluminio / PMMA
TIME CHARGE:
6-8 Hr
TIME USE:
8-10 Hr
SENSOR:
Crepuscular
DIMMABLE:
SI

REF	W	SIZE	Brightness	COLOR	°K
LM6371	60	530X900H mm	190	Gris / Grey	6000K
LM6372	100	700X990H mm	260	Gris / Grey	6000K
LM6373	200	670X995H mm	390	Gris / Grey	6000K



Synchronizing Needs



ON: Encendido de farola

OFF: Apagado de farola

+: Aumentar intensidad

-: Reducir intensidad

AUTO: Encendido a partir de 10-16 lux al 100%, el nivel de intensidad se verá afectado según el nivel de carga de la batería.

3H: Funcionamiento al 100% durante 3 horas, acabado ese tiempo vuelve al modo auto.

5H: Funcionamiento al 100% durante 5 horas, acabado ese tiempo vuelve al modo auto.

8H: Funcionamiento al 100% durante 8 horas, acabado ese tiempo vuelve al modo auto.

ON: Streetlight on

OFF: Streetlight off

+: Increase intensity

-: Decrease intensity

AUTO: On at 10-16 lux at 100%, intensity level will be affected by battery charge level.

3H: Operates at 100% for 3 hours, then returns to auto mode.

5H: Operates at 100% for 5 hours, then returns to auto mode.

8H: Operates at 100% for 8 hours, then returns to auto mode.



Solar LED Streetlight for Public Lighting



BRIGHTNESS:
63 LM/W
CRI:
80
ANGLE:
140°X75°
LIGHT SOURCE:
Epistar
WORKING TEMP:
-30°C ~ +50°C
DURABILITY:
50000 Hr
IP:
IP65
MATERIAL:
ABS / Aluminio
TIME CHARGE:
6-8 Hr
TIME USE:
6-8 Hr
SENSOR:
Crepuscular / Movimiento
DIMMABLE:
Si

REF	W	SIZE	Brightness	COLOR	°K
LM6368	20	200X390H mm	650	Gris / Grey	6000K
LM6369	40	230X500H mm	1300	Gris / Grey	6000K
LM6370	60	240X620H mm	1950	Gris / Grey	6000K



ON/OFF: Encendido y apagado de farola

2H NO SEN: Funcionamiento al 100% durante 2 hr.

3H NO SEN: Funcionamiento al 100% durante 3 hr.

4H NO SEN: Funcionamiento al 100% durante 4 hr.

AUTO : Encendido a partir de 10-16 lux al 100%, el nivel de intensidad se verá afectado según el nivel de carga de la batería.

⊖: Reducir intensidad (Solo para modo AUTO)

⊕: Aumentar intensidad (Solo para modo AUTO)

RADAR: Modo con sensor, funcionamiento del 100% durante 10 segundos aproximadamente, en el momento de no detectar movimiento se reduce al 25%.

ON/OFF: Streetlight On and Off

2H NO SEN: Operates at 100% for 2 hr. No Sensor

3H NO SEN: Operates at 100% for 3 hr. No Sensor

4H NO SEN: Operates at 100% for 4 hr. No Sensor

AUTO: On at 10-16 lux at 100%, intensity level will be affected by battery charge level.

⊖: Decrease intensity (Only for AUTO mode)

⊕: Increase intensity (Only for AUTO mode)

RADAR: Sensor mode, operates at 100% for approximately 10 seconds when motion is detected, then reduces to 25% when no motion is detected.



Villa Lantern Painted Oven Steel



IP:
IP20
MATERIAL:
Acero

REF	SIZE	COLOR	INCLUDES
LM6443	400X710H MM	Black / White	Tornillos

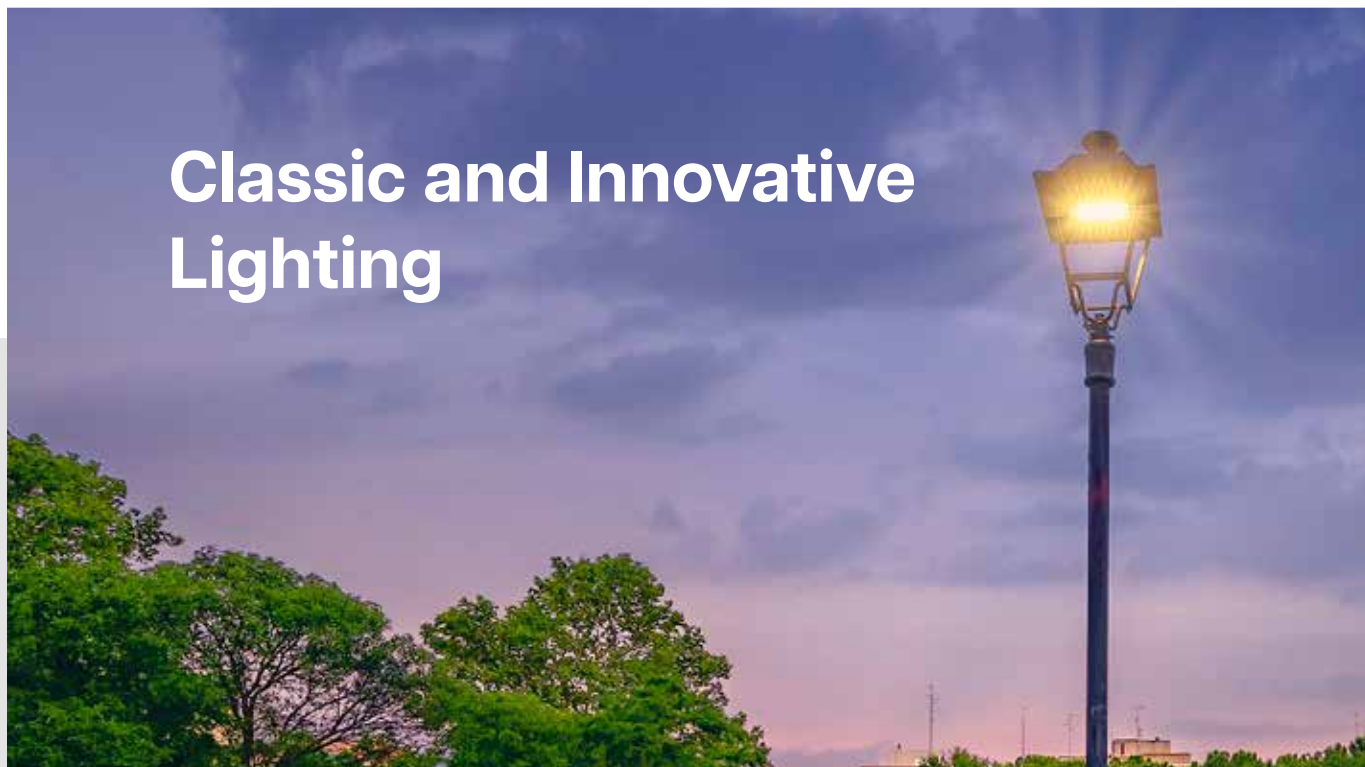

Compatible accessories:



Chapa Adaptación
LM6444



Chapa Adaptación doble
LM6445



Foco Modular Led Retrofit
50W
LM6341 - 6000K
LM6342 - 4500K
LM6340 - 3000K



Optica 145°x70°
LM6315



Driver Meanwell
Xig-50-A 50W
LM2105

Kain Solar LED Streetlight



BRIGHTNESS:
2600
CRI:
75
ANGLE:
120°
LIGHT SOURCE:
Sanan
WORKING TEMP:
-30°C ~ + 50°C
DURABILITY:
30000 Hr
IP:
IP65
MATERIAL:
Aluminio / PMMA
TIME CHARGE:
6-8 Hr
TIME USE:
10-12 Hr
SENSOR:
Crepuscular / Movimiento
DIMMABLE:
S
BATTERY:
3.2V 20.000mAH



REF	W	SIZE	COLOR	*K
LM6535	80	410X410X120H mm	Negro / Black	6000K



ON/OFF: Encendido y apagado de farola
2H NO SEN: Funcionamiento al 100% durante 2 horas.
3H NO SEN: Funcionamiento al 100% durante 3 horas.
4H NO SEN: Funcionamiento al 100% durante 4 horas.
AUTO : Encendido a partir de 10-16 lux al 100%, el nivel de intensidad se verá afectado según el nivel de carga de la batería.
 Ⓞ -: Reducir intensidad (Solo para modo AUTO)
 Ⓞ +: Aumentar intensidad (Solo para modo AUTO)
RADAR: Modo con sensor, funcionamiento del 100% durante 10 segundos aproximadamente, en el momento de no detectar movimiento se reduce al 50%.

ON/OFF: Encendido y apagado de farola
2H NO SEN: Funcionamiento al 100% durante 2 horas.
3H NO SEN: Funcionamiento al 100% durante 3 horas.
4H NO SEN: Funcionamiento al 100% durante 4 horas.
AUTO : Encendido a partir de 10-16 lux al 100%, el nivel de intensidad se verá afectado según el nivel de carga de la batería.
 Ⓞ -: Reducir intensidad (Solo para modo AUTO)
 Ⓞ +: Aumentar intensidad (Solo para modo AUTO)
RADAR: Modo con sensor, funcionamiento del 100% durante 10 segundos aproximadamente, en el momento de no detectar movimiento se reduce al 50%.



Harlem Series LED Streetlight



BRIGHTNESS:
110 LM/W
CRI:
70
POWER SUPPLY:
200-240V ac
ANGLE:
140°x65°
LIGHT SOURCE:
Lumileds
POWER FACTOR:
0,9
WORKING TEMP:
-20°C ~ + 45°C
IK:
8
DURABILITY:
30000 Hr
IP:
IP65
MATERIAL:
Aluminio / PMMA

REF	W	SIZE	COLOR	*K
LM6551	50	160X390H mm	Gris / Grey	5000K
LM6552	50	160X390H mm	Gris / Grey	4000K
LM6553	50	160X390H mm	Gris / Grey	2700K
LM6554	100	200X470H mm	Gris / Grey	5000K
LM6555	100	200X470H mm	Gris / Grey	4000K
LM6556	100	200X470H mm	Gris / Grey	2700K
LM6557	150	220X530H mm	Gris / Grey	5000K
LM6558	150	220X530H mm	Gris / Grey	4000K
LM6559	150	220X530H mm	Gris / Grey	2700K
LM6560	200	250X600H mm	Gris / Grey	5000K
LM6561	200	250X600H mm	Gris / Grey	4000K
LM6562	200	250X600H mm	Gris / Grey	2700K



Compatible accessories:



Brazo articulado
LM6255



Soporte de pared
LM6657A





BRIGHTNESS:
8000
CRI:
70
POWER SUPPLY:
110-240V ac
ANGLE:
120°
POWER FACTOR:
0.9
WORKING TEMP:
-20°C ~ +45°C
IK:
8
Kv:
2 Kv
DURABILITY:
30000 Hr
IP:
IP65
MATERIAL:
Aluminio / PC

REF	W	SIZE	COLOR	°K
LM6344	100	520X523H mm	Gris Antracita	5000K
LM6345	100	520X523H mm	Gris Antracita	4000K
LM6346	100	520X523H mm	Gris Antracita	2700K





BRIGHTNESS:
140 LM/W
CRI:
80
POWER SUPPLY:
100-240V ac
ANGLE:
150°X70°
LIGHT SOURCE:
Lumileds
POWER FACTOR:
0,9
WORKING TEMP:
-20°C ~ + 45°C
IK:
8
Kv:
10 Kv
DURABILITY:
50000 Hr
IP:
IP65
MATERIAL:
ABS / Aluminio
DIMMABLE:
1-10V

REF	W	SIZE	COLOR	*K
GA6901	30	568X200X109mm	RAL 9006	5000K
GA6902	30	568X200X109mm	RAL 9006	4000K
GA6903	30	568X200X109mm	RAL 9006	2700K
GA6904	60	568X200X109mm	RAL 9006	5000K
GA6905	60	568X200X109mm	RAL 9006	4000K
GA6906	60	568X200X109mm	RAL 9006	2700K
GA6907	90	613X240X109mm	RAL 9006	5000K
GA6908	90	613X240X109mm	RAL 9006	4000K
GA6909	90	613X240X109mm	RAL 9006	2700K



Compatible accessories:



LF-SCD010B
Convertor a Dali



Installation

Farola con brazo articulado, el brazo articulado nos permite distintos tipos de instalación.

En vertical o horizontal, ya que el mismo se adapta a cualquier tipo de instalación, el diámetro de fijación es de 60 mm.

Lamppost with articulated arm, the articulated arm allows for various types of installation.

In vertical or horizontal positions, as it adapts to any type of installation, the fixing diameter is 60 mm.

Driver Sosen

SS-40VA-T50B es un controlador LED de corriente constante de **40W de la prestigiosa marca Sosen**

Dispone de protección frente a cortocircuitos, protección contra sobrecarga y protección contra sobrecalentamiento.

Dispone de una garantía de 5 años ofrecida por el mismo fabricante.

SS-40VA-T50B is a 40W constant current LED driver from the prestigious brand Sosen.

It features protection against short circuits, overload protection, and overheat protection.

It comes with a 5-year warranty provided by the manufacturer.

Nivel

Esta farola esta equipada en su parte central con un nivel para para facilitar su instalación.

Gracias a este sistema el cabezal permanecerá totalmente en la posición deseada.

This streetlight is equipped in its central part with a level to facilitate its installation.

Thanks to this system, the head will remain completely in the desired position.

QUALITY





154. Adjustable LED Floodlight Navi

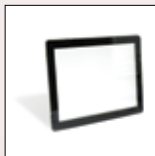

155. Double-sided LED Poster Display



156. LED Spotlight for Single-phase Berna Track



156. LED Spotlight for Fast Monophasic Track



156. LED Spotlight for Single-phase Aras Track



156. LED Spotlight for Single-phase Clean Track 30W



157. Lamp Holder Spotlight for Single-phase Movie Track



158. GU10 Track Spotlight State



159. Carril Monofásico MaxPower



160. LED Spotlight for Monophasic Profast Track 30W



162. No Flicker LED Spotlight for Three-phase Lepsie Track



163. LED Spotlight for Three-phase Turin Track



163. LED Spotlight for Three-phase Milan Track



164. Two-meter Three-phase Track



168. LED Spotlight Series 16 mm for Magnetic Track

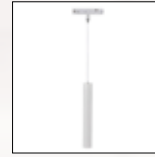

168. LED Spotlight Series 16 mm 10W for Magnetic Track



168. LED Spotlight Series 16 mm Plus 10W for Magnetic Track 48V



168. LED Lounge Spotlight Series 16 mm for Magnetic Track



169. LED Hallway Spotlight Series 16 mm for Magnetic Track



169. LED Linear Spotlight Series 16 mm for Magnetic Track



170. 16mm Surface Magnetic Track Series



170. 16mm Recessed Magnetic Track Series

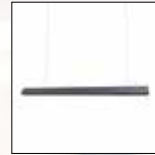

172. Linear LED Lamp Viena (UGR 17)

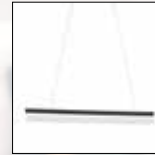

172. LED Linear Lamp Vision

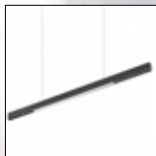

173. Linear LED Lamp Viena II (UGR 17)



173. Menie 28W LED High Bay



174. Linear LED Spotlight Vienna



176. Cobfix LED Module



177. Arumled LED Module



178. Adjustable LED Tube Square / Round Spotlights



180. Track-mounted Adjustable LED Downlight



181. String of 20 Modules of 3 Samsung SMD LEDs



181. String of 20 Modules of 3 Samsung SMD LEDs



181. String of 20 Modules of 1 Samsung SMD LED

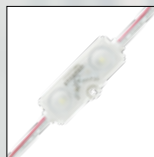

181. String of 20 Modules of 2 Samsung SMD LEDs



182. String of 20 Modules of 4 Samsung SMD LEDs



182. String of 20 Modules of 3 Samsung SMD LEDs



182. String of 20 Modules of 3 Samsung SMD LEDs 12V DC 1W



182. String of 20 Modules of 3 Sanan SMD LEDs 220V AC 3W



183. String of 20 Modules of 4 Samsung SMD LEDs 12V DC 2W



183. String of 20 Modules of 2 Samsung SMD LEDs 12V DC 2W

Iluminación Comercial



Commercial
Lighting

Adjustable LED Floodlight Navi



IP:
 IP20
BRIGHTNESS:
 3600
ANGLE:
 120°
MATERIAL:
 Aluminium / Cristal / PC
POWER SUPPLY:
 170-265V AC
CRI:
 80
IK:
 5
POWER FACTOR:
 0,9
WORKING TEMP:
 -20°C + 45°C
UGR:
 19
LIGHT SOURCE:
 Lumileds
DURABILITY:
 40000 Hr

REF	W	SIZE	CUT	COLOR	°K
LM3017	36	240X150X85H mm	220X125 mm	Blanco / White	CCT



Includes Swift CCT



Adjustable LED Floodlight Navi

El foco proyector LED orientable Navi es una excelente opción para iluminar grandes espacios de manera eficiente y de alta calidad. Con 36W, este proyector ofrece una potencia lumínica capaz de satisfacer las necesidades más exigentes.

Uno de los aspectos destacados de este foco es su índice de reproducción cromática (**CRI**) de **80**, lo que significa que la luz emitida por este proyector es capaz de mostrar los Colores de manera fiel y natural. Esto es especialmente importante en entornos donde es necesario distinguir con precisión los Colores, como en tiendas, museos o salas de exposiciones.

Además, el **angle de apertura de 120°** permite una distribución de luz uniforme en toda el área a iluminar, evitando así zonas de sombra o deslumbramiento. Este angle de apertura resulta ideal para espacios amplios como almacenes, naves industriales o áreas de trabajo.

El factor de protección **IK 5** garantiza la resistencia de este proyector ante impactos externos, como golpes o vibraciones. Gracias a este índice de protección, el foco proyector LED Navi es adecuado para su instalación en zonas donde la robustez es una prioridad.

The adjustable LED spotlight Navi is an excellent choice for efficiently and effectively illuminating large spaces with high quality. With 36W, this spotlight provides a luminous output capable of meeting the most demanding needs.

One of the highlights of this spotlight is its color Rendering Index (**CRI**) of **80**, which means that the light emitted by this projector is capable of displaying Colors faithfully and naturally. This is especially important in environments where it is necessary to accurately distinguish Colors, such as in stores, museums, or exhibition halls.

Additionally, the **120° beam angle** allows for uniform light distribution throughout the illuminated area, thus avoiding shadowy areas or glare. This beam angle is ideal for spacious environments such as warehouses, industrial buildings, or work areas.

The **IK 5** protection rating ensures the durability of this spotlight against external impacts, such as bumps or vibrations. Thanks to this protection rating, the LED spotlight Navi is suitable for installation in areas where robustness is a priority.

Double-sided LED Poster Display



IP: IP20
 MATERIAL: Aluminium / PC
 POWER SUPPLY: 12V dc
 LIGHT SOURCE: Led
 DURABILITY: 50000 Hr

REF	W	SIZE	COLOR	°K
LM3020	7,5	330X244X80 mm	Black / Transparent	6000K
LM3021	10	330X455X80 mm	Black / Transparent	6000K



Includes
 2 Tensores
 2 Uniones
 2 Cables

Double-sided LED Poster Display

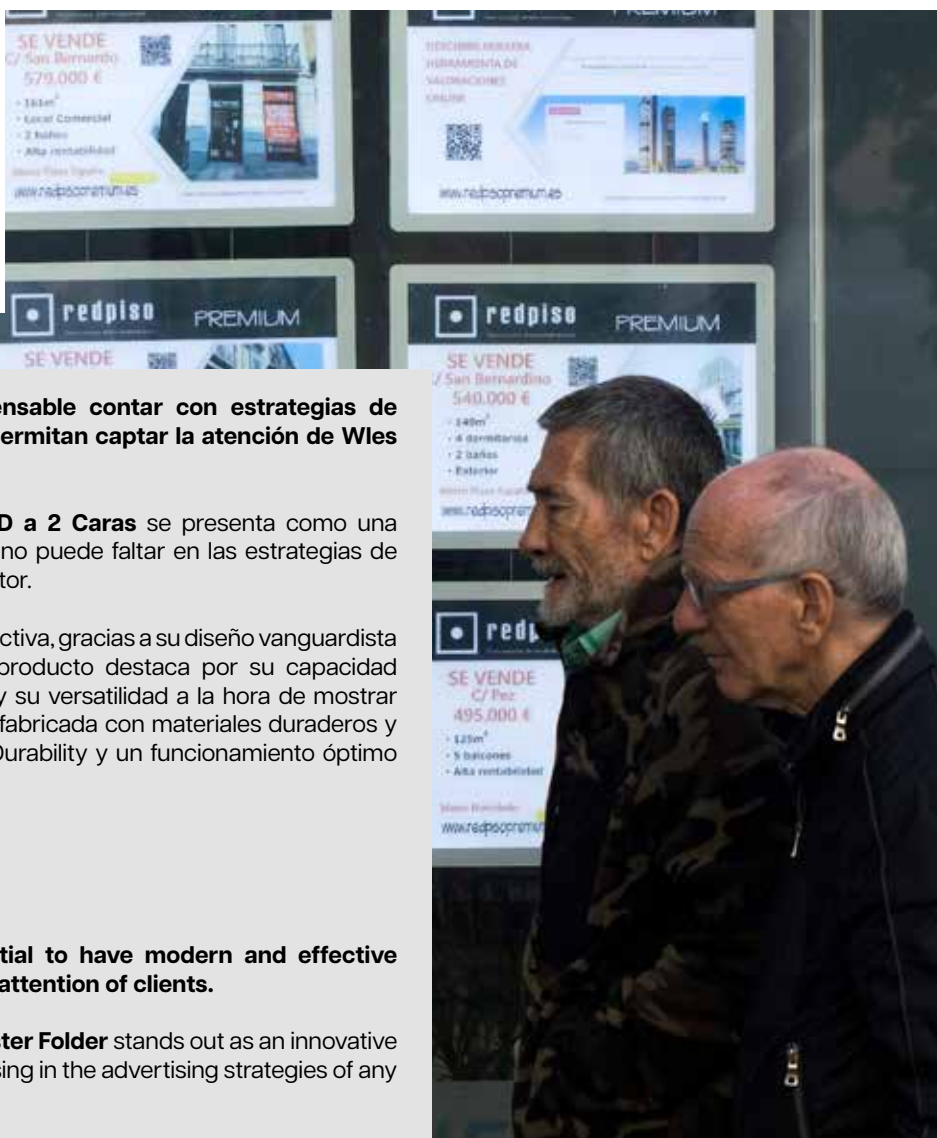
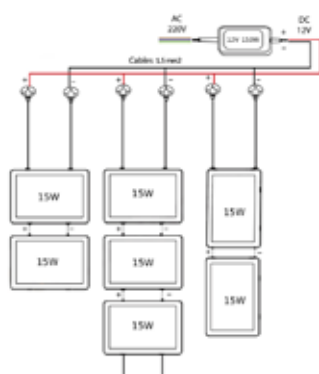

En el sector inmobiliario, es indispensable contar con estrategias de marketing modernas y eficaces que permitan captar la atención de Wles clientes.

En este sentido, la **Carpeta Poster LED a 2 Caras** se presenta como una herramienta innovadora y práctica que no puede faltar en las estrategias de publicidad de cualquier empresa del sector.

La **Carpeta LED 2 Caras** es altamente efectiva, gracias a su diseño vanguardista y a su destacada funcionalidad. Este producto destaca por su capacidad de proyectar imágenes de alta calidad y su versatilidad a la hora de mostrar mensajes publicitarios. Su carcasa está fabricada con materiales duraderos y resistentes, lo que garantiza una larga Durability y un funcionamiento óptimo incluso en condiciones adversas.

In the real estate sector, it is essential to have modern and effective marketing strategies that capture the attention of clients.

In this regard, the **Double-sided LED Poster Folder** stands out as an innovative and practical tool that should not be missing in the advertising strategies of any company in the sector.

The **Double-sided LED Poster Folder** is highly effective, thanks to itscutting-edge design and outstanding functionality. This product stands out for its ability to project high-quality images and its versatility in displaying advertising messages. Its housing is made of durable and resistant materials, ensuring a long lifespan and optimal operation even in adverse conditions.

LED Spotlight for Single-phase Berna Track



IP:
IP20
BRIGHTNESS:
1200
ANGLE:
24°
MATERIAL:
Aluminium
POWER SUPPLY:
85-265V AC
CRI:
80
POWER FACTOR:
0,95
LIGHT SOURCE:
Bridgelux
DURABILITY:
30000 Hr

REF	W	SIZE	COLOR	*K
LM3105	12	140X135H mm	Blanco / White	6000K
LM3106	12	140X135H mm	Blanco / White	4500K
LM3107	12	140X135H mm	Blanco / White	3000K
LM3108	12	140X135H mm	Negro / Black	6000K
LM3109	12	140X135H mm	Negro / Black	4500K
LM3110	12	140X135H mm	Negro / Black	3000K



LED Spotlight for Fast Monophasic Track



IP:
IP20
BRIGHTNESS:
3000
ANGLE:
24°
MATERIAL:
Aluminium
POWER SUPPLY:
170-240V AC
CRI:
80
POWER FACTOR:
0,95
LIGHT SOURCE:
Sanan
DURABILITY:
30000 Hr

REF	W	SIZE	COLOR	*K
LM3141	30	160X155H mm	Negro / Black	6000K
LM3142	30	160X155H mm	Negro / Black	4500K
LM3143	30	160X155H mm	Negro / Black	3000K
LM3144	30	160X155H mm	Blanco / White	6000K
LM3145	30	160X155H mm	Blanco / White	4500K
LM3146	30	160X155H mm	Blanco / White	3000K



LED Spotlight for Single-phase Aras Track



IP:
IP20
BRIGHTNESS:
3000
ANGLE:
36°
MATERIAL:
Aluminium
POWER SUPPLY:
170-265V AC
CRI:
85
POWER FACTOR:
0,95
WORKING TEMP:
-20°C + 45°C
LIGHT SOURCE:
Sanan
DURABILITY:
30000 Hr

REF	W	SIZE	COLOR	*K
LM3162	30	285HX85X95 mm	Negro / Black	CCT
LM3161	30	285HX85X95 mm	Blanco / White	CCT



Includes Swift CCT

LED Spotlight for Single-phase Clean Track 30W



IP:
IP40
BRIGHTNESS:
3000
ANGLE:
Lente Dual 24-60°
MATERIAL:
Aluminium
POWER SUPPLY:
160-240V AC
CRI:
80
POWER FACTOR:
0,95
WORKING TEMP:
-20°C + 45°C
LIGHT SOURCE:
Epistar
DURABILITY:
30000 Hr

REF	W	SIZE	COLOR	*K
LM3163	30	160X170H mm	Blanco / White	CCT
LM3164	30	160X170H mm	Negro / Black	CCT



Includes Swift CCT



IP:
IP20
MATERIAL:
Metal

REF	W MAX	SIZE	LIGHT SOURCE	COLOR
LM4342	40	90X240H mm	GU10	Negro / Black
LM4344	40	170X380H mm	E27	Negro / Black



Lamp Holder Spotlight for Single-phase Movie Track

Súmergete en la nostalgia del cine clásico con nuestro Foco Movie, una pieza de iluminación inspirada en la estética del cine retro que añadirá un toque de encanto vintage a cualquier espacio.

Diseño Retro: Con su diseño inspirado en el cine retro, el Foco Movie evoca la elegancia y la nostalgia del Hollywood dorado. Sus líneas limpias y su acabado en metal añaden un toque de autenticidad y sofisticación a cualquier ambiente.

Versatilidad de Bombillas: Disponible en dos versiones, una para bombillas **GU10** y otra para bombillas **E27**, ofrece una versatilidad excepcional para adaptarse a tus necesidades de iluminación específicas. Ya sea que prefieras la eficiencia energética de las bombillas LED **GU10** o la calidez de las bombillas incandescentes **E27**, este foco te ofrece la libertad de elegir.

Calidad Duradera: Fabricado con materiales de alta calidad, incluyendo metal resistente, el Foco Movie está diseñado para perdurar. Su construcción robusta garantiza una durabilidad excepcional y un rendimiento fiable a lo largo del tiempo, proporcionándote una iluminación de calidad sin compromisos.

Aplicaciones Versátiles: Desde iluminar tu sala de estar con un toque de nostalgia cinematográfica hasta realzar la atmósfera de tu estudio de cine en casa, el Foco Movie es perfecto para una variedad de aplicaciones. Utilízalo como un punto focal en tu sala de estar, dormitorio, estudio o cualquier otro espacio donde desees añadir un toque de estilo y personalidad única.

Instalación Sencilla: Con su diseño intuitivo y fácil de instalar, el Foco Movie te permite disfrutar de una iluminación excepcional en cuestión de minutos. Simplemente monta el foco en la ubicación deseada, instala la bombilla correspondiente y disfruta de una iluminación atmosférica al instante.

Agrega un toque de nostalgia cinematográfica a tu hogar u oficina con el Foco Movie. Descubre la combinación perfecta de estilo retro y funcionalidad excepcional en esta impresionante pieza de iluminación.

Immerse yourself in the nostalgia of classic cinema with our Movie Spotlight, a lighting fixture inspired by the aesthetics of retro film that will add a touch of vintage charm to any space.

Retro Design: With its design inspired by retro cinema, the Movie Spotlight evokes the elegance and nostalgia of the golden age of Hollywood. Its clean lines and metal finish add an authentic touch of sophistication to any environment.

Bulb Versatility: Available in two versions, one for GU10 bulbs and another for E27 bulbs, it offers exceptional versatility to suit your specific lighting needs. Whether you prefer the energy efficiency of GU10 LED bulbs or the warmth of E27 incandescent bulbs, this spotlight gives you the freedom to choose.

Durable Quality: Made with high-quality materials, including sturdy metal, the Movie Spotlight is designed to last. Its robust construction ensures exceptional durability and reliable performance over time, providing you with uncompromising quality lighting.

Versatile Applications: From illuminating your living room with a touch of cinematic nostalgia to enhancing the atmosphere of your home movie studio, the Movie Spotlight is perfect for a variety of applications. Use it as a focal point in your living room, bedroom, studio, or any other space where you want to add a touch of style and unique personality.

Easy Installation: With its intuitive and easy-to-install design, the Movie Spotlight allows you to enjoy exceptional lighting in a matter of minutes. Simply mount the spotlight in the desired location, install the corresponding bulb, and enjoy atmospheric lighting instantly.

Add a touch of cinematic nostalgia to your home or office with the Movie Spotlight. Discover the perfect combination of retro style and exceptional functionality in this stunning lighting fixture.

GU10 Track Spotlight State



IP:
IP20
MATERIAL:
Metal

REF	SIZE	COLOR
LM4356	105X70X137H mm	Blanco / White



IP
IP20

Material
Aluminium



Carril Monofásico MaxPower

REF	SIZE	COLOR
LM3201	1000X40X20H mm	Blanco / White
LM3206	1000X40X20H mm	Negro / Black
LM3203	2000X42X20H mm	Blanco / White
LM3204	2000X42X20H mm	Negro / Black



Includes
1 cover
1 220V connector

Compatible accessories:



LM3263
LED Track Hanging System 3M



LM3251
Reinforced I Connector for Monophase Track



LM3254
Reinforced I Connector for Monophase Track



LM3253
T Connector for Monophase Track



LM3256
T Connector for Monophase Track



LM3252
L Connector for Monophase Track



LM3255
L Connector for Monophase Track



LM3262
Recessed base with white track



LM3261
Surface-mounted base with white track



IP
IP20

Brightness
3000

Angle
36°

Power supply
220-240V AC

CRI
90

Light source
Osram

Durability
50000 Hr

Material
Aluminium

Power factor
0.95

REF	W	SIZE	COLOR	°K
GA3181	30	185X155H mm	Blanco / White	6000K
GA3182	30	185X155H mm	Blanco / White	4500K
GA3183	30	185X155H mm	Blanco / White	3000K
GA3184	30	185X155H mm	Negro / Black	6000K
GA3185	30	185X155H mm	Negro / Black	4500K
GA3186	30	185X155H mm	Negro / Black	3000K

LED Spotlight for Monophase Profast Track 30W



QUALITY



No Flicker LED Spotlight for Three-phase Lepsie Track



- IP**
IP20

- Luminosidad**
3520

- Angle**
36°

- Material**
Aluminium / PC

- Alimentación**
220-240V AC

- CRI**
85

- Power factor**
0.95

- Light Source**
Lumileds

- Durability**
50000Hr

REF	W	SIZE	COLOR	°K
LM3101	32	230X70X250H mm	Blanco / White	6000K
LM3102	32	230X70X250H mm	Blanco / White	4500K
LM3103	32	230X70X250H mm	Blanco / White	3000K

5 YEARS
OF WARRANTY



Descubre la innovación en iluminación con nuestro foco de carril Lepsie. Equipado con una fuente lumínica de la prestigiosa marca Lumileds, este foco garantiza una iluminación potente y eficiente con una luminosidad impresionante de 3520 lúmenes.

Su rendimiento está respaldado por la confiable tecnología de driver de Philips, asegurando un funcionamiento óptimo y duradero.

Con la seguridad y confianza que brinda la marca, este foco de carril cuenta con una garantía de 5 años, proporcionando tranquilidad y respaldo a tu inversión. Disfruta de la calidad de iluminación excepcional y la durabilidad de nuestros productos, diseñados para satisfacer las demandas de cualquier espacio. Eleva la experiencia de iluminación con este foco de carril que combina tecnología de vanguardia con la garantía de marcas líderes en la industria.

LED Spotlight for Three-phase Turin Track



IP:
IP20
BRIGHTNESS:
2690
ANGLE:
24°
MATERIAL:
Aluminium/PC
POWER SUPPLY:
170-240V AC
CRI:
90
POWER FACTOR:
0,95
LIGHT SOURCE:
Bridgelux
DURABILITY:
30000 Hr

REF	W	SIZE	COLOR	°K
LM3147	30	150X169 mm	Negro / Black	6000K
LM3148	30	150X169 mm	Negro / Black	4500K
LM3149	30	150X169 mm	Negro / Black	3000K
LM3150	30	150X169 mm	Blanco / White	6000K
LM3151	30	150X169 mm	Blanco / White	4500K
LM3152	30	150X169 mm	Blanco / White	3000K



LED Spotlight for Three-phase Milan Track



IP:
IP20
BRIGHTNESS:
2700
ANGLE:
36°
MATERIAL:
Aluminium/PC
POWER SUPPLY:
220-240V AC
CRI:
90
POWER FACTOR:
0,95
LIGHT SOURCE:
Osram
DURABILITY:
30000 Hr

REF	W	SIZE	COLOR	°K
LM3119	30	230X80X180H mm	Negro / Black	6000K
LM3120	30	230X80X180H mm	Negro / Black	4500K
LM3121	30	230X80X180H mm	Negro / Black	3000K



IP
IP20

Material
Aluminium



Two-meter Three-phase Track

REF	SIZE	COLOR
LM3209	2000X32X36H mm	Blanco / White
LM3220	2000X32X36H mm	Negro / Black



Includes
2 covers

Compatible accessories:



LM3218
T-shaped Connector for Three-phase Track



LM3214
T-shaped Connector for Three-phase Track



LM3217
L-shaped Connector for Three-phase Track



LM3213
L-shaped Connector for Three-phase Track



LM3210
Inline Connector for Three-phase Track



LM3216
Inline Connector for Three-phase Track



LM3221
Inline Connector for Three-phase Track



LM3222
Inline Connector for Three-phase Track



LM3215
X-shaped Connector for Three-phase Track



LM3223
Connector and Plug for Three-phase Track



LM3224
Connector and Plug for Three-phase Track



LM3225
White Flexible Connector for Three-phase Track



LM3226
Black Flexible Connector for Three-phase Track



LM3263
LED Track Hanging System 3M



Serie 16 mm

MAGNETIC ESTILE

La iluminación comercial para carriles LED magnéticos es una solución innovadora y moderna que está ganando popularidad en el mundo de la iluminación.

Estos sistemas de iluminación ofrecen ventajas significativas en términos de versatilidad, eficiencia energética y facilidad de instalación.

Los carriles magnéticos son una opción inteligente para instalar luminarias en espacios comerciales, ya que permiten una colocación rápida y eficiente.

Commercial lighting for magnetic LED tracks is an innovative and modern solution that is gaining popularity in the lighting industry.

These lighting systems offer significant advantages in terms of versatility, energy efficiency, and ease of installation.



LED Spotlight Series 16 mm for Magnetic Track



IP:
IP20
BRIGHTNESS:
100 LM/W
ANGLE:
36°
MATERIAL:
Aluminium
POWER SUPPLY:
48V dc
CRI:
90
LIGHT SOURCE:
Osram
DURABILITY:
30000 Hr
CRI:
90
UGR:
17
POWER FACTOR:
0.95

REF	W	SIZE	COLOR	°K
LM3615	7	115X100H mm	Negro / Black	3000K
LM3616	7	115X100H mm	Blanco / White	3000K
LM3617	10	115X110H mm	Negro / Black	3000K
LM3618	10	115X110H mm	Blanco / White	3000K
LM3619	20	115X120H mm	Negro / Black	3000K
LM3550	20	115X120H mm	Blanco / White	3000K
LM3565	7	115X100H mm	Negro / Black	4000K
LM3566	7	115X100H mm	Blanco / White	4000K
LM3567	10	115X110H mm	Negro / Black	4000K
LM3568	10	115X110H mm	Blanco / White	4000K
LM3569	20	115X120H mm	Negro / Black	4000K
LM3570	20	115X120H mm	Blanco / White	4000K



LED Spotlight Series 16 mm 10W for Magnetic Track



IP:
IP20
BRIGHTNESS:
100
ANGLE:
36°
MATERIAL:
Aluminium
POWER SUPPLY:
48V dc
CRI:
90
POWER FACTOR:
0.95
WORKING TEMP:
-20°C + 45°C
UGR:
17
LIGHT SOURCE:
Osram
DURABILITY:
30000 Hr

REF	W	SIZE	COLOR	°K
LM3573	10	40X300H mm	Negro / Black	4000K
LM3574	10	40X300H mm	Blanco / White	4000K
LM3623	10	40X300H mm	Negro / Black	3000K
LM3624	10	40X300H mm	Blanco / White	3000K



LED Spotlight Series 16 mm Plus 10W for Magnetic Track 48V



IP:
IP20
BRIGHTNESS:
100 LM/W
ANGLE:
120°
MATERIAL:
Aluminium
POWER SUPPLY:
48V dc
CRI:
90
POWER FACTOR:
0.95
WORKING TEMP:
-20°C + 45°C
UGR:
19
LIGHT SOURCE:
Osram
DURABILITY:
30000 Hr

REF	W	SIZE	COLOR	°K
LM3571	10	40X300H mm	Negro / Black	4000K
LM3621	10	40X300H mm	Negro / Black	3000K
LM3572	10	40X300H mm	Blanco / White	4000K
LM3622	10	40X300H mm	Blanco / White	3000K



LED Lounge Spotlight Series 16 mm for Magnetic Track



IP:
IP20
BRIGHTNESS:
100 LM/W
ANGLE:
120°
MATERIAL:
Aluminium
POWER SUPPLY:
48V dc
CRI:
90
POWER FACTOR:
0.95
WORKING TEMP:
-20°C + 45°C
UGR:
19
LIGHT SOURCE:
Osram
DURABILITY:
30000 Hr

REF	W	SIZE	COLOR	°K
LM3551	10	355X17X22H mm	Negro / Black	4000K
LM3552	10	355X17X22H mm	Blanco / White	4000K
LM3553	20	655X17X22H mm	Negro / Black	4000K
LM3554	20	655X17X22H mm	Blanco / White	4000K
LM3601	10	355X17X22H mm	Negro / Black	3000K
LM3602	10	355X17X22H mm	Blanco / White	3000K
LM3603	20	655X17X22H mm	Negro / Black	3000K
LM3604	20	655X17X22H mm	Blanco / White	3000K



LED Hallway Spotlight Series 16 mm for Magnetic Track



IP:
IP20
BRIGHTNESS:
100 LM/W
ANGLE:
36°
MATERIAL:
Aluminium
POWER SUPPLY:
48V dc
POWER FACTOR:
0,95
CRI:
90
WORKING TEMP:
-20°C + 45°C
UGR:
17
LIGHT SOURCE:
Osram
DURABILITY:
30000 Hr

REF	W	SIZE	COLOR	°K
LM3555	12	283X17X22H mm	Negro / Black	4000K
LM3556	12	283X17X22H mm	Blanco / White	4000K
LM3557	18	396X17X22H mm	Negro / Black	4000K
LM3558	18	396X17X22H mm	Blanco / White	4000K
LM3559	24	511X17X22H mm	Negro / Black	4000K
LM3560	24	511X17X22H mm	Blanco / White	4000K
LM3605	12	283X17X22H mm	Negro / Black	3000K
LM3606	12	283X17X22H mm	Blanco / White	3000K
LM3607	18	396X17X22H mm	Negro / Black	3000K
LM3608	18	396X17X22H mm	Blanco / White	3000K
LM3609	24	511X17X22H mm	Negro / Black	3000K
LM3610	24	511X17X22H mm	Blanco / White	3000K



LED Linear Spotlight Series 16 mm for Magnetic Track



IP:
IP20
BRIGHTNESS:
1200
ANGLE:
36°
MATERIAL:
Aluminium
POWER SUPPLY:
48V dc
CRI:
90
POWER FACTOR:
0,95
WORKING TEMP:
-20°C + 45°C
UGR:
17
LIGHT SOURCE:
Osram
DURABILITY:
30000 Hr

REF	W	SIZE	COLOR	°K
LM3561	6	125X75H mm	Negro / Black	4000K
LM3562	6	125X75H mm	Blanco / White	4000K
LM3563	12	245X60H mm	Negro / Black	4000K
LM3564	12	245X60H mm	Blanco / White	4000K
LM3611	6	125X75H mm	Negro / Black	3000K
LM3612	6	125X75H mm	Blanco / White	3000K
LM3613	12	245X60H mm	Negro / Black	3000K
LM3614	12	245X60H mm	Blanco / White	3000K



MAGNETIC EFFECT CONNECTION

IP
IP20

Material
Aluminium

Installation
Surface



16mm Surface Magnetic Track Series

REF	SIZE	COLOR
LM3576	2000X26,9X29,05H mm	Blanco / White
LM3575	2000X26,9X29,05H mm	Negro / Black



Includes
2 covers / 1 diffuser

Compatible accessories:



LM3579
Power Supply Connector for 16mm Magnetic Track Series



LM3580
Power Supply Connector for 16mm Magnetic Track Series



LM3581
Double Connection for 16mm Magnetic Track Series



LM3233
Double Connection for 16mm Magnetic Track Series



LM3582
150W 48Vdc Driver for Detail Series 16mm Magnetic Track



LM3583
150W 48Vdc Driver for Detail Series 16mm Magnetic Track



LM3584
100W 48Vdc Driver for Detail Series 16mm Magnetic Track



LM3585
100W 48Vdc Driver for Detail Series 16mm Magnetic Track



LM3596
Horizontal X Union for 16mm Magnetic Track Series



LM3597
Horizontal X Union for 16mm Magnetic Track Series



LM3592
Vertical L Union for 16mm Magnetic Track Series



LM3593
Vertical L Union for 16mm Magnetic Track Series



LM3594
Horizontal T Union for 16mm Magnetic Track Series



LM3595
Horizontal T Union for 16mm Magnetic Track Series



LM3590
Horizontal L Union for 16mm Magnetic Track Series



LM3591
Horizontal L Union for 16mm Magnetic Track Series



LM3598
Hangers for Magnetic LED Track 1.5 Meters Series 16mm



LM3599
Straight Union for 16mm Magnetic Track Series



LM3600
Accessory for Recessed Mounting Magnetic Track Series 16mm



IP
IP20

Material
Aluminium

Installation
Embedded

16mm Recessed Magnetic Track Series

REF	SIZE	CUT	COLOR
LM3577	2000X36,9X29,05H mm	26,9 mm	Negro / Black
LM3578	2000X36,9X29,05H mm	26,9 mm	Blanco / White



Includes
2 covers / 1 diffuser

Compatible accessories:



LM3951
Flat Inline Connector



LM3952
Flat Corner Connector



LM3953
Flat T Connector



LM3954
Flat Vertical Corner Connector



LM3955
Flat X Connector



LM3579
Power Supply Connector for 16mm Magnetic Track Series



LM3580
Power Supply Connector for 16mm Magnetic Track Series



LM3581
Double Connection for 16mm Magnetic Track Series



LM3233
Double Connection for 16mm Magnetic Track Series



LM3582
150W 48Vdc Driver for Detail Series 16mm Magnetic Track



LM3583
150W 48Vdc Driver for Detail Series 16mm Magnetic Track



LM3584
100W 48Vdc Driver for Detail Series 16mm Magnetic Track



LM3585
100W 48Vdc Driver for Detail Series 16mm Magnetic Track



KB3575
Clips for Recessed 16mm Magnetic Track Series

Linear LED Lamp Viena (UGR 17)



IP:
IP20
BRIGHTNESS:
4800
ANGLE:
30°
MATERIAL:
Aluminium
POWER SUPPLY:
170-265V AC
CRI:
90
POWER FACTOR:
0,9
UGR:
17
LIGHT SOURCE:
Osram
DURABILITY:
30000 Hr

REF	W	SIZE	COLOR	°K
LM3409	40	1070X34X60H mm	Negro / Black	4500K
LM3410	40	1070X34X60H mm	Negro / Black	3000K



LED Linear Lamp Vision



IP:
IP20
BRIGHTNESS:
3600
MATERIAL:
Aluminium
POWER SUPPLY:
170-265V AC
CRI:
90
POWER FACTOR:
0,9
UGR:
19
LIGHT SOURCE:
Osram
DURABILITY:
30000 Hr

REF	W	SIZE	COLOR	°K
LM3415	30	1125X20X70H mm	Negro / Black	4500K
LM3416	30	1125X20X70H mm	Negro / Black	3000K



Linear LED Lamp Viena II (UGR 17)



IP:
IP20
BRIGHTNESS:
4800
ANGLE:
30X120°
MATERIAL:
Aluminium
POWER SUPPLY:
170-265V AC
POWER FACTOR:
0.9
CRI:
90
UGR:
19
LIGHT SOURCE:
Osram
DURABILITY:
30000 Hr

REF	W	SIZE	COLOR	°K
LM3412	40	1070X34X60H mm	Negro / Black	4500K
LM3413	40	1070X34X60H mm	Negro / Black	3000K



Menie 28W LED High Bay



IP:
IP20
ANGLE:
60°
MATERIAL:
Aluminium
POWER SUPPLY:
160-240V AC
CRI:
97
POWER FACTOR:
0.96
LIGHT SOURCE:
Smd Led
DURABILITY:
30000 Hr

REF	W	SIZE	COLOR	°K
LM6623	28	260HX240 mm	Rojo / Red	Rojo / Red
LM6624	28	260HX240 mm	Verde / Green	Verde / Green
LM6622	28	260HX240 mm	Azul / Blue	Azul / Blue



FISH

Las bancas de las pescaderías suelen ser extensas para dar cabida a pescados, mariscos o moluscos, todo el género fresco debe exponerse para que al cliente final se le haga la boca agua nada más verlos, por ello, llamar la atención con una luz debidamente proyectada es vital, la adaptabilidad de la iluminación que proporciona las ópticas de **Ledme-europa** permite que todo el producto iluminado, generalmente desde el techo, se vea espectacular.

The benches in fishmongers are usually extensive to accommodate fish, seafood, or shellfish. All the fresh produce must be displayed so that the final customer's mouth waters just by looking at them. Therefore, grabbing attention with properly projected light is vital. The adaptability of the lighting provided by Ledme-europa's optics ensures that all the illuminated products, typically from the ceiling, look spectacular.

MEAT

Creas un ambiente que invite a la compra, ya que es capaz de mostrar la mejor cara de los cárnicos ofrecidos, resaltando el color natural de éstos.

Para cada tipo de productos se debe tener una solución de iluminación de carnicerías que logre resaltar su atractivo. Aquí es donde entra en juego la variación cromática, siendo específica para cada uno de los productos cárnicos y sacando todo el provecho posible.

Create an environment that invites purchase, as it is capable of showcasing the best face of the offered meats, highlighting their natural COLOR.

For each type of product, a butcher shop lighting solution must be in place to highlight its appeal. This is where chromatic variation comes into play, tailored specifically to each of the meat products and extracting the maximum benefit possible.

VEGETABLES

El atractivo de la sección de productos frescos (más que cualquier otra) va a determinar muchísimo la imagen y el éxito del supermercado.

Una buena iluminación garantiza la buena visualización y conservación del producto además de correcta imagen de conjunto para el comercio que hace aumentar los ingresos procedentes de los productos frescos.

The appeal of the fresh produce section (more than any other) will greatly determine the image and success of the supermarket.

Good lighting ensures proper visibility and preservation of the product, as well as a correct overall image for the store, which increases revenue from fresh products.



QUALITY



Linear LED Spotlight Vienna

REF	W	SIZE	CUT	COLOR	*K
GA3002	10	143X38X35H mm	137X32 mm	Negro / Black	4000K
GA3003	10	143X38X35H mm	137X32 mm	Negro / Black	3000K
GA3005	20	283X45X35H mm	275X32 mm	Negro / Black	4000K
GA3006	20	283X45X35H mm	275X32 mm	Negro / Black	3000K
GA3008	30	417X45X35H mm	405X33 mm	Negro / Black	4000K
GA3009	30	417X45X35H mm	405X33 mm	Negro / Black	3000K

OSRAM
LEDS INCLUDED





IP
IP20

Brightness
110 LM/W

Angle
36°

Power supply
220-240V AC

CRI
90

Light source
Osram

Durability
50000 Hr

UGR
17

Power factor
0.9

Working temp
-20°C + 45°C



Cobfix LED Module



IP:
IP20
BRIGHTNESS:
920
ANGLE:
24°
MATERIAL:
Aluminium / PC
POWER SUPPLY:
170-265V AC
CRI:
80
LIGHT SOURCE:
Bridgelux
DURABILITY:
30000 Hr
UGR:
19
POWER FACTOR:
0.6
WORKING TEMP:
-20°C + 45°C



REF	W	SIZE	COLOR	*K
LM4304	10	69X70 mm	Negro / Black	6000K
LM4305	10	69X70 mm	Negro / Black	4500K
LM4306	10	69X70 mm	Negro / Black	3000K



LM4369 Blanco / White
LM4373 Negro / Black
Surface Mount Ring 1L for
Cobfix 10W Module



LM4370 Blanco / White
LM4374 Negro / Black
Surface Mount Ring 2L for
Cobfix 10W Module



LM4371 Blanco / White
LM4375 Negro / Black
Surface Mount Ring 3L for
Cobfix 10W Module



LM4372 Blanco / White
LM4376 Negro / Black
Surface Mount Ring 4L for
Cobfix 10W Module



LM4361 Blanco / White
LM4365 Negro / Black
Recessed Mount Ring for
Cobfix 10W Module



LM4362 Blanco / White
LM4366 Negro / Black
Recessed Mount Ring 2L
for Cobfix 10W Module



LM4363 Blanco / White
LM4367 Negro / Black
Recessed Mount Ring 3L
for Cobfix 10W Module



LM4364 Blanco / White
LM4368 Negro / Black
Recessed Mount Ring 4L
for Cobfix 10W Module



LM4377 Blanco / White
LM4378 Negro / Black
Recessed Mount Ring for
Cobfix 10W Module

Compatible accessories:



LM2128
Emergency Conversion
Kit Up to 20W



LF-GDE014YG
Driver LiFud Triac 25-42V
8-14W No Flicker



LM4381
Trim Ring for Cobfix 10W
Module



LM4382
Trim Ring for Cobfix 10W
Module



LM4383
Trim Ring for Cobfix 10W
Module



LM4384
Trim Ring for Cobfix 10W
Module



IP: IP20
BRIGHTNESS: 700
ANGLE: 36°
MATERIAL: Aluminium / PC
POWER SUPPLY: 170-265V AC
CRI: 85
LIGHT SOURCE: Cree
DURABILITY: 25000 Hr
POWER FACTOR: 0.6
WORKING TEMP: -20°C + 45°C



REF	W	SIZE	COLOR	*K
LM4301	7	45X50 mm	Negro / Black	6000K
LM4302	7	45X50 mm	Negro / Black	4500K
LM4303	7	45X50 mm	Negro / Black	3000K



LM4331
 Ring for
 ARUMLED/GU10/MR16
Lani



LM4333
 Ring for
 ARUMLED/GU10/MR16
Manu



LM4335
 Ring for
 ARUMLED/GU10/MR16
Mankaili



LM4332
 Ring for
 ARUMLED/GU10/MR16
Maika



LM4337
 Ring for
 ARUMLED/GU10/MR16
Miata



LM4330
 Ring for
 ARUMLED/GU10/MR16
Maka



LM4336
 Ring for
 ARUMLED/GU10/MR16
Hopaka



LM4334
 Ring for
 ARUMLED/GU10/MR16
Loau



LM4379
 Ring for
 ARUMLED/GU10/MR16



LM4380
 Ring for
 ARUMLED/GU10/MR16

Compatible accessories:



LM2128
 Emergency Conversion
 Kit Up to 20W



LF-GDE014YG
 Driver LiFud Triac 25-42V
 8-14W No Flicker



Adjustable LED Tube Square / Round Spotlights

REF	W	SIZE	CUT	COLOR	°K
GA4182	12	110X105H mm	90 mm	Blanco / White	4000K
GA4183	12	110X105H mm	90 mm	Blanco / White	3000K
GA4185	12	115X115X105H mm	90X90 mm	Blanco / White	4000K
GA4186	12	115X115X105H mm	90X90 mm	Blanco / White	3000K





IP
IP20

Brightness
110 LM/W

Angle
36°

Power supply
220-240V AC

CRI
90

Light source
Osram

Durability
50000 Hr

UGR
17

Power factor
0.9

Working temp
-20°C + 45°C



REF	W	SIZE	CUT	COLOR	°K
GA4188	24	210X114X105H mm	184X90 mm	Blanco / White	4000K
GA4189	24	210X114X105H mm	184X90 mm	Blanco / White	3000K

Adjustable LED Downlight Track



IP:
IP20
BRIGHTNESS:
100 LM/W
ANGLE:
24°
MATERIAL:
Aluminium / Cristal
POWER SUPPLY:
85-265V AC
CRI:
80
LIGHT SOURCE:
Epistar
DURABILITY:
30000 Hr
UGR:
19
POWER FACTOR:
0.88
WORKING TEMP:
-20°C + 45°C

REF	W	SIZE	CUT	COLOR	°K
LM4129	15	113X113X90H mm	98 mm	Blanco / White	6000K
LM4130	15	113X113X90H mm	98 mm	Blanco / White	4500K
LM4131	15	113X113X90H mm	98 mm	Blanco / White	3000K
LM4132	30	165X140H mm	150 mm	Blanco / White	4500K
LM4133	30	165X140H mm	150 mm	Blanco / White	3000K
LM4134	30	165X140H mm	150 mm	Blanco / White	6000K



Track-mounted Adjustable LED Downlight

El foco proyector LED orientable Navi es una excelente opción para iluminar grandes espacios de manera eficiente y de alta calidad. Con una potencia de 36W, este proyector ofrece una potencia lumínica capaz de satisfacer las necesidades más exigentes.

Uno de los aspectos destacados de este foco es su índice de reproducción cromática (CRI) de 80, lo que significa que la luz emitida por este proyector es capaz de mostrar los Colores de manera fiel y natural. Esto es especialmente importante en entornos donde es necesario distinguir con precisión los Colores, como en tiendas, museos o salas de exposiciones.

Además, el **angle de apertura de 120°** permite una distribución de luz uniforme en toda el área a iluminar, evitando así zonas de sombra o deslumbramiento. Este angle de apertura resulta ideal para espacios amplios como almacenes, naves industriales o áreas de trabajo.

El factor de protección **IK 5** garantiza la resistencia de este proyector ante impactos externos, como golpes o vibraciones. Gracias a este índice de protección, el foco proyector LED Navi es adecuado para su instalación en zonas donde la robustez es una prioridad.

The adjustable LED spotlight Navi is an excellent choice for efficiently illuminating large spaces with high quality. With a power of 36W, this projector offers a luminous output capable of meeting the most demanding needs.

One of the highlights of this spotlight is its color rendering index (CRI) of 80, which means that the light emitted by this projector is able to accurately and naturally display Colors. This is especially important in environments where it is necessary to accurately distinguish Colors, such as in stores, museums, or exhibition halls.

Additionally, the **120° beam angle** allows for uniform light distribution throughout the area to be illuminated, thereby avoiding shadowy or glaring areas. This beam angle is ideal for spacious areas such as warehouses, industrial facilities, or workspaces.

The **IK 5** protection factor ensures the resilience of this projector against external impacts, such as shocks or vibrations. Thanks to this protection index, the LED spotlight Navi is suitable for installation in areas where robustness is a priority.



Illuminación Comercial / Cartelería LED - Commercial Lighting / LED Signage

www.ledme-europa.com

String of 20 Modules of 3 Samsung SMD LEDs



IP:
IP68
BRIGHTNESS:
135
ANGLE:
160°
MATERIAL:
PC
POWER SUPPLY:
12V DC
CRI:
80
LIGHT SOURCE:
Samsung
DURABILITY:
50000 Hr

REF	W	SIZE	COLOR	°K
LM7161	1,2	66X15 mm	Blanco / White	6500K



Includes
3M
Self-adhesive

Illuminación Comercial / Cartelería LED - Commercial Lighting / LED Signage

www.ledme-europa.com

String of 20 Modules of 3 Samsung SMD LEDs



IP:
IP68
BRIGHTNESS:
230
ANGLE:
160°
MATERIAL:
PC
POWER SUPPLY:
220V AC
CRI:
80
LIGHT SOURCE:
Samsung
DURABILITY:
50000 Hr

REF	W	SIZE	COLOR	°K
LM7166	2	66X15 mm	Blanco / White	6500K



Includes
3M
Self-adhesive

Illuminación Comercial / Cartelería LED - Commercial Lighting / LED Signage

www.ledme-europa.com

String of 20 Modules of 1 Samsung SMD LED



IP:
IP68
BRIGHTNESS:
230
ANGLE:
45°
MATERIAL:
PC
POWER SUPPLY:
12V dc
CRI:
80
LIGHT SOURCE:
Samsung
DURABILITY:
50000 Hr

REF	W	SIZE	COLOR	°K
LM7164	2	49X31 mm	Blanco / White	6500K



Includes
3M
Self-adhesive

Illuminación Comercial / Cartelería LED - Commercial Lighting / LED Signage

www.ledme-europa.com

String of 20 Modules of 2 Samsung SMD LEDs



IP:
IP68
BRIGHTNESS:
90
ANGLE:
160°
MATERIAL:
PC
POWER SUPPLY:
12V dc
CRI:
80
LIGHT SOURCE:
Samsung
DURABILITY:
50000 Hr

REF	W	SIZE	COLOR	°K
LM7165	1	41X15 mm	Blanco / White	6000K



Includes
3M
Self-adhesive

String of 20 Modules of 4 Samsung SMD LEDs



IP:
IP68
BRIGHTNESS:
165
ANGLE:
160°
MATERIAL:
PC
POWER SUPPLY:
12V DC
CRI:
80
LIGHT SOURCE:
Samsung
DURABILITY:
50000 Hr

REF	W	SIZE	COLOR	°K
LM7162	2	41X41 mm	Blanco / White	6500K



Includes
3M
Self-adhesive

String of 20 Modules of 3 Samsung SMD LEDs



IP:
IP68
ANGLE:
170°
MATERIAL:
PC
POWER SUPPLY:
12V dc
CRI:
80
LIGHT SOURCE:
Samsung
DURABILITY:
50000 Hr
BRIGHTNESS:
R-620-630
G510-525
B455-470 nm

REF	W	SIZE	COLOR	°K
LM7163	1	71X15 mm	Blanco / White	RGB



Includes
3M
Self-adhesive

String of 20 Modules of 3 Samsung SMD LEDs 12V DC 1W



IP:
IP65
ANGLE:
160°
MATERIAL:
PC
POWER SUPPLY:
12V dc
CRI:
80
LIGHT SOURCE:
Samsung
DURABILITY:
50000 Hr
BRIGHTNESS:
120 LM
DIMMABLE:
Triac
WORKING TEMP:
-20°C - + 45°C

REF	W	SIZE	COLOR	°K
LM7168	1	80X19 mm	Blanco / White	6000K



Includes
Self-adhesive

String of 20 Modules of 3 Sanan SMD LEDs 220V AC 3W



IP:
IP65
ANGLE:
55°
MATERIAL:
PC
POWER SUPPLY:
220V AC
CRI:
80
LIGHT SOURCE:
Samsung
DURABILITY:
50000 Hr
BRIGHTNESS:
120 LM
DIMMABLE:
Triac
WORKING TEMP:
-20°C - + 45°C

REF	W	SIZE	COLOR	°K
LM7170	3	126X23 mm	Blanco / White	6000K



Includes
Self-adhesive

String of 20 Modules of 4 Samsung SMD LEDs 12V DC 2W



IP:
IP65
BRIGHTNESS:
220
ANGLE:
160°
MATERIAL:
PC
POWER SUPPLY:
12V DC
CRI:
80
LIGHT SOURCE:
Samsung
DURABILITY:
50000 Hr
WORKING TEMP:
-20°C + 45°C
DIMMABLE:
Triac

REF	W	SIZE	COLOR	°K
LM7169	2	59X40 mm	Blanco / White	6000K



Includes Self-adhesive

String of 20 Modules of 2 Samsung SMD LEDs 12V DC 2W



IP:
IP65
BRIGHTNESS:
110
ANGLE:
160°
MATERIAL:
PC
POWER SUPPLY:
12V DC
CRI:
80
LIGHT SOURCE:
Samsung
DURABILITY:
50000 Hr
WORKING TEMP:
-20°C + 45°C
DIMMABLE:
Triac

REF	W	SIZE	COLOR	°K
LM7167	1	59X19 mm	Blanco / White	6000K



Includes Self-adhesive





186. LED strip Videny 60 Led/m



186. LED strip Videny RGB 120 Led/m



187. LED strip Purple 60 Led/m - 5 Metros



188. LED strip 12V Dc Smd5050 Videny 60 Led/m



188. LED strip Digital Tips Led/m



190. LED strip Digital Ritt 60 Led/m



191. LED strip Digital Messe 60 Led/m



192. Pack LED strip digital CCT



192. Pack LED strip 30 Led/m RGB



192. Pack LED strip 24V 5050 16L RGB



198. LED strip Ziadna 120 Led/m



198. LED strip Serie Clasic 120 Led/m



199. LED strip Videny 60 Led/m



199. LED strip Serie Clasic 120 Led/m



200. LED strip Clasic 120 Led/m RGB



200. LED strip Clasic 120 Led/m



201. LED strip Videny 60 Led/m



201. LED strip Ziadna 240 Led/m



202. LED strip Ziadna 120 Led/m



202. LED strip Ziadna 204 Led/m



203. LED strip Videny 60 Led/m



203. LED strip Ziadna 120 Led/m



204. LED strip Serie Clasic RGB 204 Led/m



204. LED strip Serie Letters 120 Led/m



205. LED strip Half (5Mm de Ancho)



205. LED strip Cobled Nake 576 Led/m RGB



206. LED strip Cobled Nake 320 Led/m



206. LED strip Cobmaori 256 Led/m



207. LED strip Videny 96 Led/m



207. LED strip Classic Ip20 RGB+CCT 168 Led/m



208. LED strip Videny RGB+C (6000 K) 60 Led/m



208. LED strip Videny RGB+W (3000 K) 60 Led/m



209. LED strip Videny RG-B+CCT 60 Led/m



209. LED strip Ziadna 240 Led/m



210. LED strip Ziadna CCT 192 Led/m



211. 12W LED Shelf Bar



212. LED strip Half 6.5 Mm



212. LED strip Prostrip



213. LED strip Cobpoint



213. LED strip Ruzok



214. LED strip Brescia



214. LED strip Fast RGB



215. LED strip Bergamo



215. LED strip Como



216. LED strip Arast



216. LED Neon Flexible Prozny RGB



217. LED Neon Flexible Prozny



217. LED Neon Flexible Proline



218. LED Neon Flexible Letters



220. Slim 8X4 Silicone Cover for LED Strips



220. Rectangular 15X8 Silicone Cover for LED Strips



220. Recessed Silicone Cover for Led Strips



221. Cube Silicone Cover for LED Strips



221. Cylinder 20X20 Silicone Cover for LED Strips



221. Cylinder 22X10 Silicone Arc for LED Strips



221. Drop 13X6 Silicone Cover for LED Strips



221. Door 15X15 Silicone Cover for LED Strips

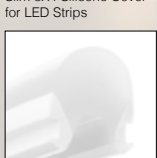

222. Silicone Cover for Next Generation LED Strips



224. Power Supplies Mean Well



225. 0-10V Dimmable Power Supplies

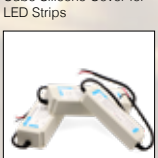

226. Power Supplies for 24V IP66 LED Strips

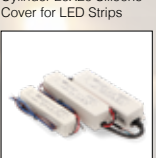

227. Mean Well IP67 Power Supplies for LED Strips



228. Dimmable Triac Power Supply 24V

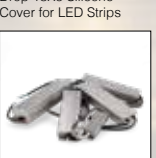

229. Power Supply for 24V IP65 LED Strips

Tiras, Neón LED y Perfil



230.
Slim Power Supplies
for LED Strips



231.
Power Supply for LED
Strips (Special for
Profiles)

LED Strips, Neon and Profile

LED strip Videny 60 Led/m



LIGHT SOURCE:
Smd 5050
FINISH:
PCB Blanco / White
ANGLE:
120°
WORKING TIME:
-20°C + 45°C
DURABILITY:
30000 Hr
POWER SUPPLY:
12V DC
MATERIAL:
PC
CRI:
80

REF	SIZE	W	CUT	IP	WAVELENGTH / BRIGHTNESS	°K
LM2006	10X5000	14 W/M	5 CM	IP65	R-620-630/ G510-525 / B455-470 nm	RGB
LM2015	10X5000	14 W/M	5 CM	IP20	R-620-630/ G510-525 / B455-470 nm	RGB



Includes
3M
Self-adhesive

Compatible accessories:



LM2911
Conector de Hipopótamo
Para Tira Led y Cable
Ip65 10Mm 4Pin



LM2912
Conector de Hipopótamo
Para Tira Led Ip65
10Mm 4Pin



LM2919
Conector de Hipopótamo
L Para Tira Led Ip65
10Mm 4Pin



LM2081
Controlador Regulador
Led Rgb/rgbw/rgb+Cct



LM2083
Controlador Regulador
Smarthome Led
Rgb/rgbw/rgb+Cct



LM2085
Controlador Regulador
Rgb+Cct 12/24V Dc +
Mando Rf



LM2088
Mando Rf Regulador Led
Rgb+Cct 4 Zonas

LED strip Videny RGB 120 Led/m



LIGHT SOURCE:
Smd 5050
FINISH:
PCB Blanco / White
ANGLE:
120°
DURABILITY:
30000 Hr
POWER SUPPLY:
12V DC
MATERIAL:
PC
CRI:
80

REF	SIZE	W	CUT	IP	WAVELENGTH / BRIGHTNESS	°K
LM2009	10X5000	18 W/M	3 CM	IP20	R-620-630/ G510-525 / B455-470 nm	RGB



Includes
3M
Self-adhesive

Compatible accessories:



LM2081
Controlador Regulador
Led Rgb/rgbw/rgb+Cct



LM2083
Controlador Regulador
Smarthome Led
Rgb/rgbw/rgb+Cct



LM2085
Controlador Regulador
Rgb+Cct 12/24V Dc +
Mando Rf



LM2088
Mando Rf Regulador Led
Rgb+Cct 4 Zonas

LED strip Purple 60 Led/m - 5 Metros



LIGHT SOURCE:
Smd 5050
FINISH:
PCB Bianco / White
ANGLE:
120°
WORKING TIME:
-20°C + 45°C
DURABILITY:
30000 Hr
POWER SUPPLY:
12V DC
MATERIAL:
PC
CRI:
80

REF	SIZE	W	CUT	IP	WAVELENGTH / BRIGHTNESS	°K
LM2201	10X5000 mm	14 W/M	5 CM	IP20	P380-410	Purple



Compatible accessories:



LM2901
Conector de Hipopótamo
Para Tira Led y Cable
Ip20 10Mm 4Pin



LM2902
Conector de Hipopótamo
Para Tira Led Ip20
10Mm 4Pin



LM2917
Conector de Hipopótamo
L Para Tira Led Ip20
10Mm 4Pin



LM2928
Conector Ultramini Para
Tira 10Mm 12V/24V
Monocolor



LM2929
Conector Ultramini Para
Tira 10Mm 12V/24V
Monocolor A Cable de
2 Hilos



LM2081
Controlador Regulador
Led Rgb/rgbw/rgb+Cct



LM2083
Controlador Regulador
Smarthome Led
Rgb/rgbw/rgb+Cct



LM2084
Controlador Regulador
Monocolor+Cct 12/24V
Dc + Mando Rf



LM2087
Mando Rf Regulador Led
Monocolor 4 Zonas

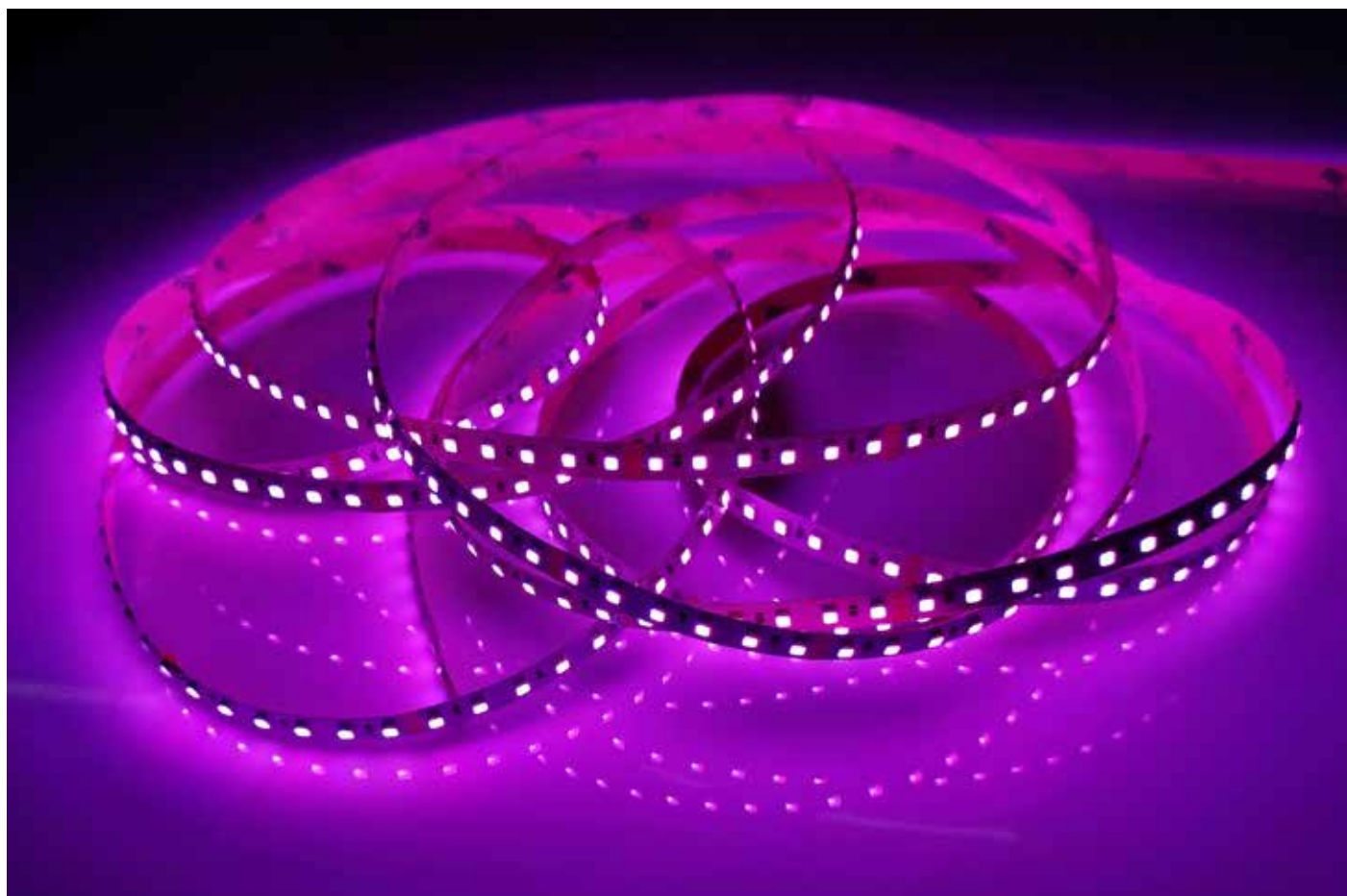

LED strip 12V Dc Smd5050 Videny 60 Led/m



LIGHT SOURCE:
Smd 2835
FINISH:
PCB Blanco / White
ANGLE:
120°
WORKING TIME:
-20°C + 45°C
30000 Hr
POWER SUPPLY:
12V DC
MATERIAL:
PC
CRI:
80

REF	SIZE	W	CUT	IP	WAVELENGTH / BRIGHTNESS	°K
LM2001	10X5000 mm	14 W/M	5 CM	IP65	1400 LM/M	6000 K
LM2002	10X5000 mm	14 W/M	5 CM	IP65	1400 LM/M	4000 K
LM2005	10X5000 mm	14 W/M	5 CM	IP65	1400 LM/M	3000 K
LM2409	10X5000 mm	14 W/M	5 CM	IP65	1400 LM/M	2700 K
LM2010	10X5000 mm	14 W/M	5 CM	IP20	1400 LM/M	6000 K
LM2016	10X5000 mm	14 W/M	5 CM	IP20	1400 LM/M	4000 K
LM2014	10X5000 mm	14 W/M	5 CM	IP20	1400 LM/M	3000 K
LM2410	10X5000 mm	14 W/M	5 CM	IP20	1400 LM/M	2700 K



Includes
3M
Self-adhesive

Compatible accessories:



LM2907
Conector de Hipopótamo
Para Tira Led y Cable
Ip65 10Mm 2Pin



LM2908
Conector de Hipopótamo
Para Tira Led Ip65
10Mm 2Pin



LM2081
Controlador Regulador
Led Rgb/rgbw/rgb+Cct



LM2082
Controlador Regulador
Led Rgb/rgbw/rgb+Cct



LM2084
Controlador Regulador
Monocolor+Cct 12/24V
Dc + Mando Rf



LM2087
Mando Rf Regulador Led
Monocolor 4 Zonas

LED strip Digital Tips Led/m - 5 Metros



LIGHT SOURCE:
Smd 2835
FINISH:
PCB Blanco / White
ANGLE:
120°
WORKING TIME:
-20°C + 45°C
30000 Hr
POWER SUPPLY:
24V DC
MATERIAL:
PC
CRI:
80

REF	SIZE	W	CUT	IP	WAVELENGTH / BRIGHTNESS	°K
LM2381	10X5000 mm	10 W/M	12,5 CM	IP20	800 LM/W	6000 K
LM2382	10X5000 mm	10 W/M	12,5 CM	IP20	800 LM/W	4500 K
LM2383	10X5000 mm	10 W/M	12,5 CM	IP20	800 LM/W	3000 K



Compatible accessories:



LM2092
Controlador Colorful
Sp105E Para Tira Led
Digital



LM2093
Controlador Musical
Sp107E Para Tira Led
Digital



LM2091
Amplificador de Señal
Para Tira Led Digital



Tira Led Digital Tips Led/m – 5 Metros

Sumérgete en un mundo de luz dinámica y emocionante con nuestra Tira LED Digital de 24 V. Diseñada para elevar cualquier espacio con su versatilidad y efectos visuales impresionantes, esta tira LED es la opción perfecta para aquellos que buscan una iluminación personalizada y cautivadora.

10 Modos de Animación: Explora una variedad de efectos visuales con nuestros **10 modos de animación**.

10 Velocidades Ajustables: Ajusta la velocidad de las animaciones para adaptarse a tus preferencias con nuestras **10 velocidades ajustables**.

Función On/Off: Con la función **On/Off** integrada, puedes encender y apagar fácilmente la tira **LED** según tus necesidades y preferencias.

Aplicaciones Versátiles: Desde decorar tu sala de estar con efectos de luz ambiental hasta dar vida a tu espacio de entretenimiento con un espectáculo de luces sincronizado con la música, las posibilidades son infinitas con nuestra **Tira LED Digital de 24 V**.

Fácil de Instalar: Con su diseño flexible y adhesivo, nuestra **Tira LED Digital** se instala fácilmente en una variedad de superficies, desde estantes y marcos de ventanas hasta barras de techo y muebles.

Immerse yourself in a world of dynamic and exciting light with our 24V Digital LED Strip. Designed to elevate any space with its versatility and stunning visual effects, this LED strip is the perfect choice for those looking for customised and captivating lighting.

10 Animation Modes: Explore a variety of visual effects with our 10 animation modes.

10 Adjustable Speeds: Adjust the speed of the animations to suit your preferences with our 10 adjustable speeds.

On/Off Function: With the built-in On/Off function, you can easily turn the LED strip on and off according to your needs and preferences.

Versatile Applications: From decorating your living room with ambient lighting effects to bringing your entertainment space to life with a light show synchronised to music, the possibilities are endless with our 24V Digital LED Strip.

Easy to Install: With its flexible, adhesive design, our Digital LED Strip installs easily on a variety of surfaces, from shelves and window frames to ceiling bars and furniture.

LED strip Digital Ritt 60 Led/m - 5 Metros



LIGHT SOURCE:
Smd 5050
FINISH:
PCB Blanco / White
ANGLE:
120°
WORKING TIME:
-20°C + 45°C
DURABILITY:
50000 Hr
POWER SUPPLY:
12V DC
MATERIAL:
PC
CRI:
80

REF	SIZE	W	CUT	IP	WAVELENGTH / BRIGHTNESS	°K
LM2018	10X5000 mm	14	5 CM	IP20	R-620-630/ G510-525 / B455-470 nm	RGBX



Compatible accessories:



KB2042
Controlador M-4000
Para Tira Led Digital Ritt/
messe



LM2091
Amplificador de Señal
Para Tira Led Digital



LM2090
Controlador Mini Colorful
Para Tira Led Digital



LM2092
Controlador Colorful
Sp105E Para Tira Led
Digital



LM2093
Controlador Musical
Sp107E Para Tira Led
Digital



**Tira Led Digital Tips Led/m
5 Metros**

Las tiras digitales LED son una forma eficiente y flexible de iluminación LED que se puede utilizar en una amplia variedad de aplicaciones. Estas tiras utilizan diodos emisores de luz (LED) de alta calidad y están disponibles en diferentes longitudes y densidades de pixel.

En términos simples, las tiras digitales LED están compuestas por una serie de LED conectados en serie y controlados por un microcontrolador programable. Cada LED en la tira puede ser controlado individualmente gracias a la tecnología digital, lo que permite crear animaciones y efectos especiales.

Estas tiras son muy versátiles y se pueden utilizar para proporcionar iluminación en interiores, para la iluminación de talleres, detrás de pantallas de televisión, en festivales, fiestas y eventos, y para crear señalización en edificios y tiendas comerciales.

Controlador DMX RGB hasta 4096px compatible con nuestras tiras digitales. Incluye 4 Canales 256 Niveles (RGB) y transformador de salida 5V DC.

Con este controlador podremos controlar Colores e intensidades de la tira conectada. También incluye un conector Jack para sonido, el cuál nos servirá para que nuestra Tira LED Digital pueda variar sus Colores e intensidades al ritmo de la música.

* Incluye Tarjeta SSD de 128MB, compatible con LEDStudio, podrá visualizar los modos de animación a través del Qr

Digital LED strips are an efficient and flexible form of LED lighting that can be used in a wide variety of applications. These strips use high quality light emitting diodes (LEDs) and are available in different lengths and pixel densities.

In simple terms, digital LED strips are composed of a series of LEDs connected in series and controlled by a programmable microcontroller. Each LED in the strip can be controlled individually thanks to digital technology, allowing animations and special effects to be created.

These strips are very versatile and can be used to provide indoor lighting, for workshop lighting, behind TV screens, at festivals, parties and events, and to create signage in commercial buildings and shops.

DMX RGB controller up to 4096px compatible with our digital strips. Includes 4 Channels 256 Levels (RGB) and a transformer with 5V DC output.

With this controller we can control colours and intensities of the connected strip. It also includes a Jack connector for sound, which will serve us so that our Digital LED Strip can vary its colours and intensities to the rhythm of the music.

* Includes 128MB SSD card, compatible with LEDStudio, you will be able to visualize your LED Strip.

LED strip Digital Messe 60 Led/m - 5 Metros



LIGHT SOURCE:
Smd 5050
FINISH:
PCB Blanco / White
ANGLE:
120°
WORKING TIME:
-20°C + 45°C
DURABILITY:
50000 Hr
POWER SUPPLY:
12V DC
MATERIAL:
PC
CRI:
80

REF	SIZE	W	CUT	IP	WAVELENGTH / BRIGHTNESS	°K
LM2020	10X5000 mm	14 W/M	1 CM	IP20	R-620-630/ G510-525 / B455-470 nm	RGBX



Compatible accessories:



KB2042
Controlador M-4000
Para Tira Led Digital Ritt/
messe



LM2091
Amplificador de Señal
Para Tira Led Digital



LM2090
Controlador Mini Colorful
Para Tira Led Digital



LM2092
Controlador Colorful
Sp105E Para Tira Led
Digital



LM2093
Controlador Musical
Sp107E Para Tira Led
Digital



Amplificador de señal para tira LED DIGITAL

¡Descubre nuestro potente amplificador de señal para tiras digitales LED!

Con tecnología de vanguardia, nuestro amplificador de señal para tiras digitales LED es la solución perfecta para mejorar y potenciar tu experiencia de iluminación LED.

IP20: Con un diseño robusto y seguro, nuestro amplificador garantiza una protección confiable contra el polvo y otras partículas.

Compatibilidad: Admite una amplia gama de señales duales de 5V-TTL, lo que significa que es compatible con una variedad de dispositivos y controladores.

Multi-canal: Con la capacidad de emitir hasta **8 canales para tiras LED direccionables**, este amplificador simplifica tu instalación al permitirte controlar múltiples tiras con un solo cable de datos.

Ya sea que estés creando un ambiente vibrante en tu hogar, decorando un espacio comercial o llevando a cabo un proyecto de iluminación a gran escala, nuestro amplificador de señal para tiras digitales LED es la elección ideal para alcanzar resultados sorprendentes y personalizados.

¡Potencia tu creatividad con nuestro amplificador de señal LED y lleva tus proyectos de iluminación al siguiente nivel!

Discover our powerful signal booster for digital LED strips!

Featuring cutting-edge technology, our digital LED strip signal booster is the perfect solution to enhance and improve your LED lighting experience.

IP20: With a robust and secure design, our amplifier ensures reliable protection against dust and other particles.

Compatibility: Supports a wide range of dual 5V-TTL signals, meaning it is compatible with a variety of devices and controllers.

Multi-channel: With the ability to output up to 8 channels for addressable LED strips, this amplifier simplifies your installation by allowing you to control multiple strips with a single data cable.

Power your creativity with our LED signal booster and take your lighting projects to the next level!

Pack LED strip digital CCT



LIGHT SOURCE:
Smd 3535
FINISH:
PCB Blanco / White
ANGLE:
120°
WORKING TIME:
-20°C + 60°C
DURABILITY:
30000 Hr
POWER SUPPLY:
12V DC
MATERIAL:
PC
CRI:
80
DIMMABLE:
SI

REF	SIZE	W	CUT	IP	WAVELENGTH / BRIGHTNESS	°K
LM2401	10X3000 mm	22	10 CM	IP20	352 LM/W	CCT
LM2403	10X5000 mm	30	10 CM	IP20	480 LM/W	CCT



Pack LED strip RGB



LIGHT SOURCE:
Smd 5050
FINISH:
PCB Blanco / White
ANGLE:
120°
WORKING TIME:
-20°C + 60°C
DURABILITY:
30000 Hr
POWER SUPPLY:
12V DC
MATERIAL:
PC
CRI:
80
DIMMABLE:
SI

REF	SIZE	W	CUT	IP	WAVELENGTH / BRIGHTNESS	°K
LM2402	10X3000 mm	16	10 CM	IP20	R-620-630/ G510-525 / B455-470 nm	RGB
LM2404	10X5000 mm	24	10 CM	IP20	R-620-630/ G510-525 / B455-470 nm	RGB



Pack LED strip 24V 5050 16L RGB



LIGHT SOURCE:
Smd 5050
FINISH:
PCB Blanco / White
ANGLE:
120°
WORKING TIME:
-20°C + 60°C
DURABILITY:
30000 Hr
POWER SUPPLY:
24V DC
MATERIAL:
PC
CRI:
80
DIMMABLE:
SI

REF	SIZE	W	CUT	IP	WAVELENGTH / BRIGHTNESS	°K
LM2405	10X30000 mm	26	50 CM	IP20	R-620-630/ G510-525 / B455-470 nm	RGB
LM2406	10X15000 mm	13	50 CM	IP20	R-620-630/ G510-525 / B455-470 nm	RGB



WORLD OF COLORS

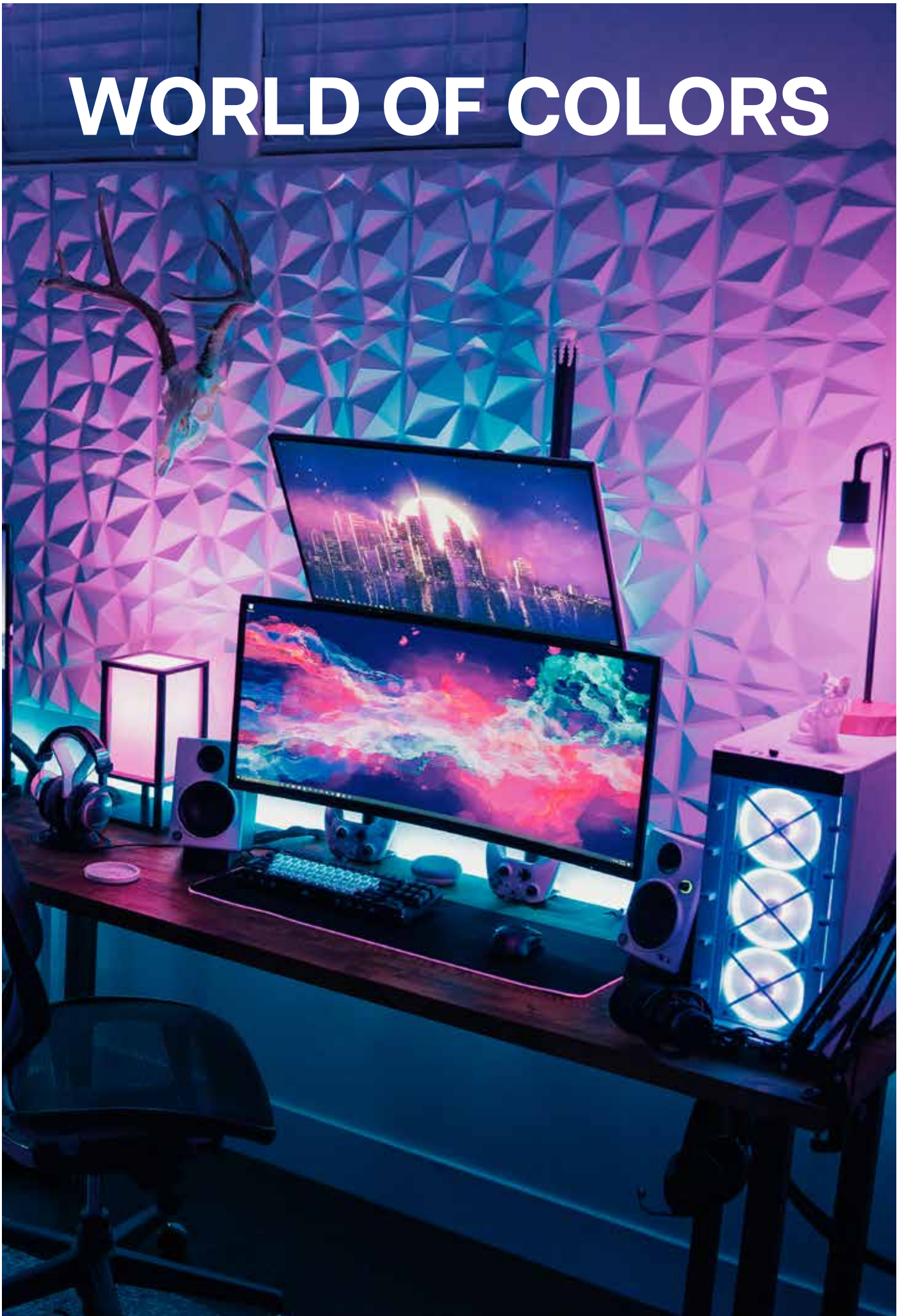





Controlador Regulador RGB+CCT 12/24V Dc + Mando Rf





Este producto adopta la frecuencia de **2.4GHz** ampliamente utilizada en todo el mundo, el método de control **GFSK**, con características de bajo consumo de energía, transmisión de larga distancia, fuerte antiinterferencia y rápida tasa de comunicación. Puede controlar la temperatura de color y el brillo de las luces inteligentes **Mi-Light / MiBoxer 2.4G**.

This product adopt world-wide used **2.4GHz** frequency, **GFSK** control method, with features of low power consumption, long distance transmitting, strong anti-interference and fast communication rate. It can control color temperature and brightness of **Mi-Light / MiBoxer 2.4G** smart light.

Ajustar la temperatura de color / Adjust color temperature

Presione brevemente el botón  una vez, luego toque  para ajustar la temperatura de color.
Short press  key once, then touch  to adjust color temperature.

Ajustar Brillo / Adjust brightness

Presione brevemente  la tecla una vez, luego toque  para ajustar el brillo. / Short press  key once, then touch  to adjust brightness.

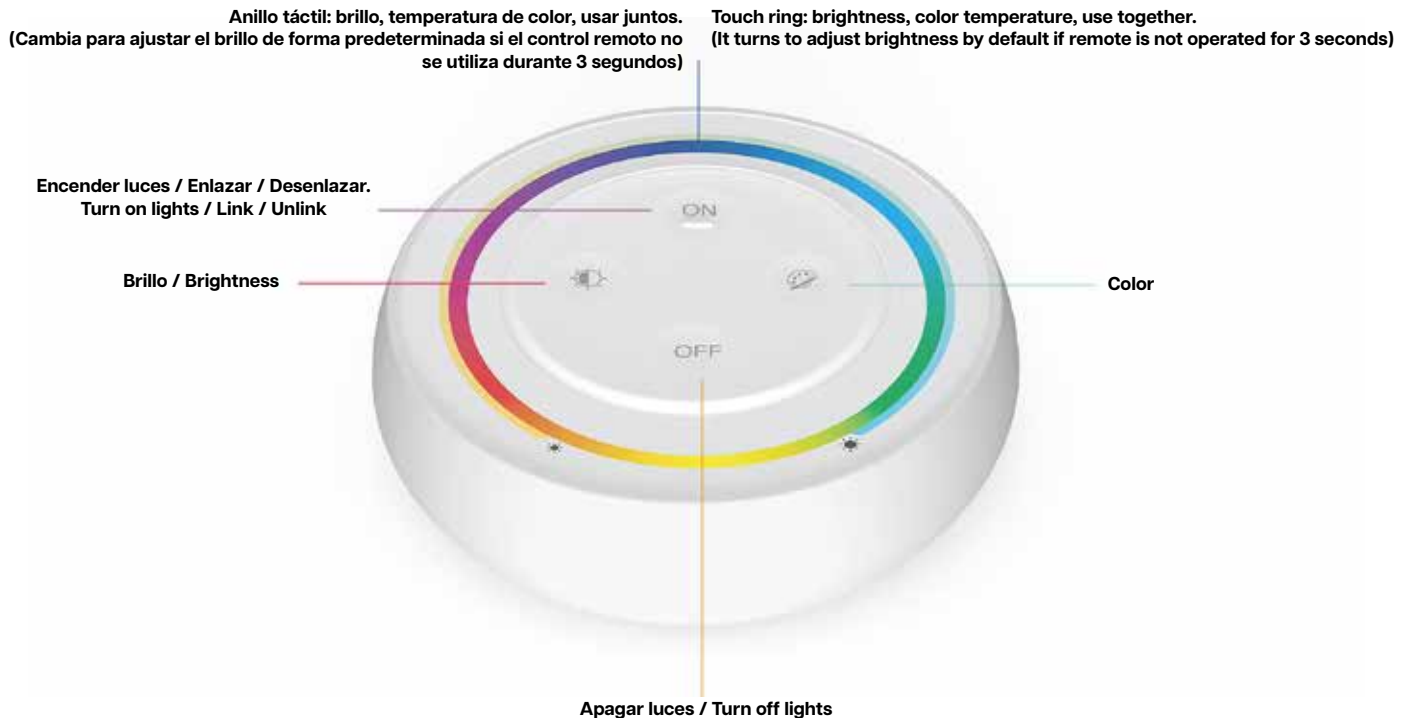

INSTRUCCIONES PARA EL CÓDIGO DE ENLACE / DESENLACE - LINKING CODE / UNLINKING CODE INSTRUCTIONS

Puedes controlar las luces después de vincular el control remoto con la luz.
You can control lights after linking remote with light.

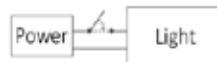

Instrucciones para el Código de Enlace - Linking Code Instructions

1. Apaga la luz, después de **10 segundos**, vuelve a encenderla.

1. Switch off light, after **10 seconds** then switch on again.

2. Presiona brevemente el botón de encendido ("ON") **3 veces** dentro de un intervalo de **3 segundos** cuando la luz esté encendida. Para desvincular, repite el proceso, esta vez **5 veces** dentro de un intervalo de **3 segundos**.

2. Press the "ON" button briefly **3 times** within a **3-second** interval when the light is on. To unlink, repeat the process, this time **5 times** within a **3-second** interval.



3. Si las luces parpadean 10 veces rápidamente, significa que el desenganche se ha realizado con éxito.
3. Lights blink 10 times quickly means unlinking is done successfully.



El desenganche falló si la luz no parpadea rápidamente. Por favor, sigue los pasos anteriores nuevamente. (Nota: Las luces que no están vinculadas no necesitan ser desvinculadas)

Unlinking failed if light is not blinking quickly, Please follow above steps again. (Note: Light haven't linked that don't need to unlink)

Atención / Attention

1. Si la luz indicadora parpadea rápidamente durante el uso, por favor, reemplace la batería a tiempo. No utilice baterías de mala calidad para evitar que se derrame líquido y dañe el control remoto.

2. No utilice el control remoto en áreas con gran cantidad de metal o en áreas con fuertes ondas electromagnéticas cercanas, ya que esto afectará seriamente la distancia de comunicación.

1. If indicator light flashes quickly when using, please replace battery in time. Do not use poor quality battery in case of leaving out liquid to damage remote.





2. Do not use remote in a large-scale metal area or an area with strong electromagnetic waves nearby, otherwise will affect communication distance seriously

Controlador Regulador Monocolor+CCT 12/24V Dc + Mando Rf





Este producto adopta la frecuencia de **2.4GHz** ampliamente utilizada en todo el mundo, el método de control **GFSK**, con características de bajo consumo de energía, transmisión de larga distancia, fuerte antiinterferencia y rápida tasa de comunicación. Puede controlar la temperatura de color y el brillo de las luces inteligentes **Mi-Light / MiBoxer 2.4G**.

This product adopt world-wide used **2.4GHz** frequency, **GFSK** control method, with features of low power consumption, long distance transmitting, strong anti-interference and fast communication rate. It can control color temperature and brightness of **Mi-Light / MiBoxer 2.4G** smart light.

Ajustar la temperatura de color / Adjust color temperature

Presione brevemente el botón  una vez, luego toque  para ajustar la temperatura de color.
Short press  key once, then touch  to adjust color temperature.

Ajustar Brillo / Adjust brightness

Presione brevemente  la tecla una vez, luego toque  para ajustar el brillo. / Short press  key once, then touch  to adjust brightness.

Anillo táctil: brillo, temperatura de color, usar juntos.
(Cambia para ajustar el brillo de forma predeterminada si el control remoto no se utiliza durante 3 segundos)
Touch ring: brightness, color temperature, use together.
(It turns to adjust brightness by default if remote is not operated for 3 seconds)

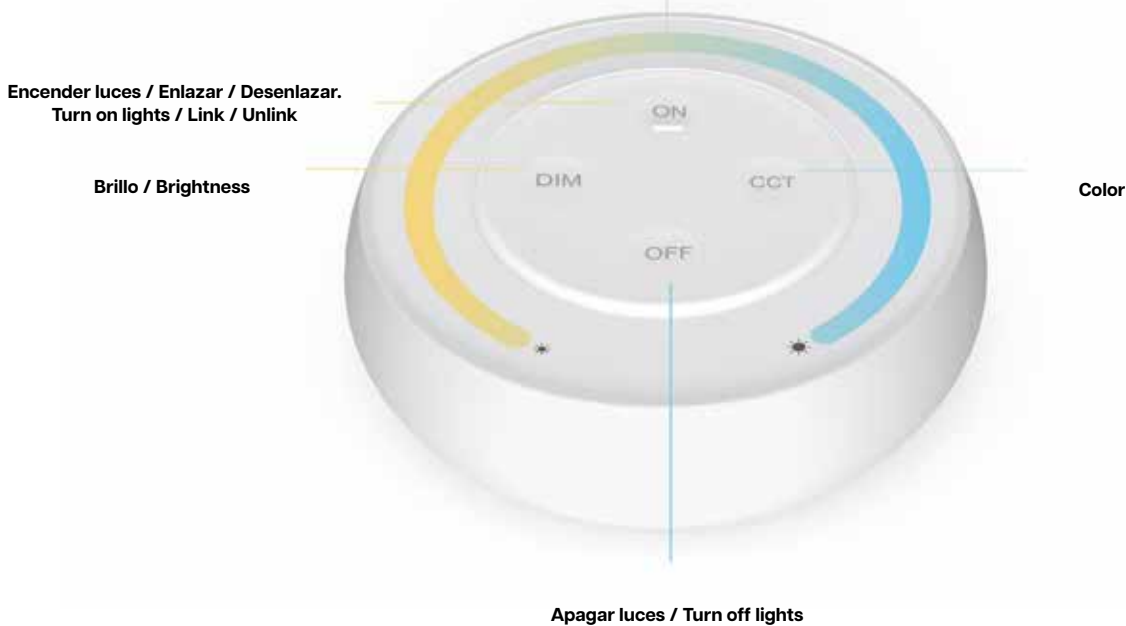

INSTRUCCIONES PARA EL CÓDIGO DE ENLACE / DESENLACE - LINKING CODE / UNLINKING CODE INSTRUCTIONS

Puedes controlar las luces después de vincular el control remoto con la luz.
You can control lights after linking remote with light.

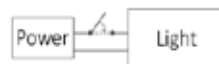

Instrucciones para el Código de Enlace - Linking Code Instructions

1. Apaga la luz, después de **10 segundos**, vuelve a encenderla.

1. Switch off light, after **10 seconds** then switch on again.

2. Presiona brevemente el botón de encendido ("ON") **3 veces** dentro de un intervalo de **3 segundos** cuando la luz esté encendida. Para desvincular, repite el proceso, esta vez **5 veces** dentro de un intervalo de **3 segundos**.

2. Press the 'ON' button briefly **3 times** within a **3-second** interval when the light is on. To unlink, repeat the process, this time **5 times** within a **3-second** interval.



3. Si las luces parpadean 10 veces rápidamente, significa que el desenchace se ha realizado con éxito.
3. Lights blink 10 times quickly means unlinking is done successfully.



El desenchace falló si la luz no parpadea rápidamente. Por favor, sigue los pasos anteriores nuevamente. (Nota: Las luces que no están vinculadas no necesitan ser desvinculadas)

Unlinking failed if light is not blinking quickly, Please follow above steps again. (Note: Light haven't linked that don't need to unlink)

Atención / Attention

1. Si la luz indicadora parpadea rápidamente durante el uso, por favor, reemplace la batería a tiempo. No utilice baterías de mala calidad para evitar que se derrame líquido y dañe el control remoto.

2. No utilice el control remoto en áreas con gran cantidad de metal o en áreas con fuertes ondas electromagnéticas cercanas, ya que esto afectará seriamente la distancia de comunicación.

1. If indicator light flashes quickly when using, please replace battery in time. Do not use poor quality battery in case of leaving out liquid to damage remote.

2. Do not use remote in a large-scale metal area or an area with strong electromagnetic waves nearby, otherwise will affect communication distance seriously

Regulador Led Triac Rf Compatible Con Pulsador

FEATURE

Don't need signal cable and change original wire layout, it's very simple to install it with low cost. Mini appearance can fit for EU/USA standard junction box. Wide application for single color triac LED lights, filament lamps, Halogen lamps.

- Smartphone APP control (need to buy 2.4GHz gateway)
- 2.4G RF wireless remote control
- Push dimming function
- Trailing edge phase-CUT technology
- 0~100% stepless dimming and flicker free
- Lowest brightness setting function
- Built-in temperature detecting switch, over heat /loading protection
- Auto transmitting function, unlimited control distance
- Screw connector is reliable and easy to do installation
- Anti-fire PC shell is more safety

CONNECTION DIAGRAM

 Please check and ensure that all cable had done correct connection before turn on it, otherwise the dimmer is easy to be damaged.

Turn On: short press "SET" 5 times quickly, mode had activated once indicator blink 3 times quickly

Turn Off: short press "SET" 5 times quickly, mode had shut down once indicator flash 3 times slowly

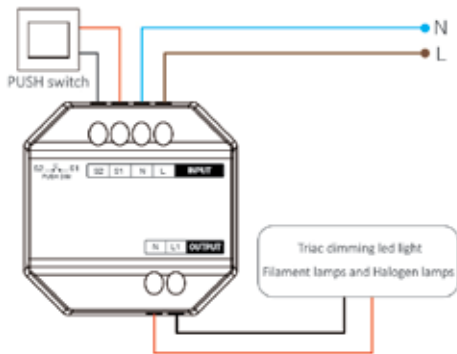

PUSH DIMMING

Short press PUSH switch:

Turn ON/OFF light

Long press PUSH switch:

- Stepless dimming brightness.
- Long press and release your finger, then repeat long pressing to increase or decrease brightness
- Please long press switch 20 seconds until all lights have same brightness with 100% level if multi dimmers had connect with same self-return switch. The quantity of dimmers which connect with same self-return switch can not be over 25 pieces, the connection cable of self-return switch can not be over 20m.



REMOTE CONTROL INSTRUCTION

Link remote



FOR K1 REMOTE

1 Learning code

Way 1: short press "SET" one time, Indicator breathes

Way 2: power off dimmer **10 seconds** and power on again

Way 3: short press Push switch (ON - OFF)



2 Press "SET" **3 times** within **3 seconds**, linking code is done once the light flashes **3 times** slowly



FOR OTHER REMOTE

1 Learning code

Press "I" any "ON" button in group zones **3 times** within **3 seconds**, linking code is done once the light flashes 3 times slowly

Unlink with remote



Long press the "SET" key for **3 seconds**, the indicator will flash **10 times** quickly, code cleared successfully.



FOR K1 REMOTE

1 Learning code

Press "SET" **5 times** within **3 seconds**, unlinking is done once the light flashes **10 times** quickly



FOR OTHER REMOTE

1 Learning code

Press "I" any "ON" button in group zones **5 times** within **3 seconds**, linking code is done once the light flashes **10 times** slowly

SET UP MIN BRIGHTNESS WITH REMOTE

FOR K1 REMOTE

1. Long press "SET" **3 seconds** until the light flashes one time, indicator is going into flashing status

2. Short press "SET" to get **10 kinds of brightness: 3%, 5%, 7%, 9%, 12%, 17%, 22%, 28%, 34%, 40%**

3. Short press rotating button to confirm setting or waiting for 10 seconds to be confirmed automatically, the light will recover brightness to previous level.

FOR OTHER REMOTE

1. Long press the "OFF" button on the remote or "O" button on the zone, until the light flashes one time, indicator is going into flashing status

2. Short press the "OFF" button on the remote or "O" button on the zone to set up **10 different brightness (3%, 5%, 7%, 9%, 12%, 17%, 22%, 28%, 34%, 40%)**

Short press any button except "OFF" to confirm setting or waiting for **10 seconds** to be confirmed automatically, the light will recover brightness to previous level

Attention: Master OFF button can set up lowest brightness for all connected dimmer

AUTO TRANSMITTING

One light can transmit the signals from the remote control to another light within 30m, as long as there is a light within 30m, the remote control distance can be limitless.



LED strip Ziadna 120 Led/m - 20 Metros



LIGHT SOURCE:
Smd 2835
FINISH:
PCB Blanco / White
ANGLE:
120°
WORKING TIME:
-20°C + 45°C
DURABILITY:
30000 Hr
POWER SUPPLY:
24V DC
MATERIAL:
PC
CRI:
80

REF	SIZE	W	CUT	IP	WAVELENGTH / BRIGHTNESS	°K
LM2427	10X20000 mm	12 W/M	4 CM	IP65	1200 LM/W	6000 K
LM2428	10X20000 mm	12 W/M	4 CM	IP65	1200 LM/W	4000 K
LM2429	10X20000 mm	12 W/M	4 CM	IP65	1200 LM/W	2700 K



20 M



Compatible accessories:



LM2080
Controlador Regulador
Led Monocolor/cct



LM2082
Controlador Regulador
Smarthome Led
Monocolor/cct



LM2084
Controlador Regulador
Monocolor+Cct 12/24V
Dc + Mando Rf



LM2087
Mando Rf Regulador Led
Monocolor 4 Zonas

LED strip Serie Clasic 120 Led/m - 10 Metros



LIGHT SOURCE:
Smd 3535
FINISH:
PCB Blanco / White
ANGLE:
120°
WORKING TIME:
-20°C + 45°C
DURABILITY:
30000 Hr
POWER SUPPLY:
24V DC
MATERIAL:
PC
CRI:
90

REF	SIZE	W	CUT	IP	WAVELENGTH / BRIGHTNESS	°K
LM2391	8X10000 mm	12 W/M	5 CM	IP20	1200 LMM	6000 K
LM2392	8X10000 mm	12 W/M	5 CM	IP20	1200 LMM	4500 K
LM2393	8X10000 mm	12 W/M	5 CM	IP20	1200 LMM	3000 K
LM2394	8X10000 mm	12 W/M	5 CM	IP20	1200 LMM	Blue
LM2395	8X10000 mm	12 W/M	5 CM	IP20	1200 LMM	Red
LM2396	8X10000 mm	12 W/M	5 CM	IP20	1200 LMM	Green
LM2399	8X10000 mm	12 W/M	5 CM	IP20	1200 LMM	2100 K
LM2411	8X5000 mm	12 W/M	5 CM	IP20	1200 LMM	6000 K
LM2412	8X5000 mm	12 W/M	5 CM	IP20	1200 LMM	4000 K
LM2413	8X5000 mm	12 W/M	5 CM	IP20	1200 LMM	2700 K
LM2414	8X5000 mm	12 W/M	5 CM	IP20	R-620-630	Red
LM2415	8X5000 mm	12 W/M	5 CM	IP20	B455-470 nm	Blue
LM2416	8X5000 mm	12 W/M	5 CM	IP20	G510-525	Green
LM2441	8X5000 mm	12 W/M	5 CM	IP65	1200 LMM	6000 K
LM2442	8X5000 mm	12 W/M	5 CM	IP65	1200 LMM	4000 K
LM2443	8X5000 mm	12 W/M	5 CM	IP65	1200 LMM	2700 K
LM2444	8X5000 mm	12 W/M	5 CM	IP65	R-620-630	Red
LM2445	8X5000 mm	12 W/M	5 CM	IP65	B455-470 nm	Blue
LM2446	8X5000 mm	12 W/M	5 CM	IP65	G510-525	Green



10 M



Includes
3M
Self-adhesive

Compatible accessories:



LM2181
Dimmer Empotrable
Tactil Monocolor Para
Tiras Led 12/24V



LM2268
Amplificador de Señal
12-24V



LM2930
Conector Ultramini Para
Tira 8Mm 12V/24
Monocolor



LM2931
Conector Ultramini
Para Tira 8Mm 12V/24V
Monocolor A Cable de
2 Hilos



LM2080
Controlador Regulador
Led Monocolor/cct



LM2082
Controlador Regulador
Smarthome Led
Monocolor/cct



LM2084
Controlador Regulador
Monocolor+Cct 12/24V
Dc + Mando Rf



LM2087
Mando Rf Regulador Led
Monocolor 4 Zonas

LED strip Videny 60 Led/m - 20 Metros



LIGHT SOURCE:
Smd 5050
FINISH:
PCB Blanco / White
BRIGHTNESS:
900 LM/M
ANGLE:
120°
WORKING TIME:
-20°C + 45°C
DURABILITY:
30000 Hr
POWER SUPPLY:
24V DC
MATERIAL:
PC
CRI:
85

REF	SIZE	W	CUT	IP	WAVELENGTH / BRIGHTNESS	°K
LM2143	10X20000 mm	14 W/M	10 CM	IP68	900 LM/M	6000 K
LM2144	10X20000 mm	14 W/M	10 CM	IP68	900 LM/M	4500 K
LM2145	10X20000 mm	14 W/M	10 CM	IP68	900 LM/M	3000 K
LM2146	10X20000 mm	14 W/M	10 CM	IP68	900 LM/M	Blue Ice



Compatible accessories:



LM2925
Conector Intermedio Para Tira Led Ip68 12Mm Out 10Mm In 2Pin



LM2926
Conector de Inicio Para Tira Led Ip68 12Mm Out 10Mm In 2Pin



LM2927
Conector Intermedio Con Cable Para Tira Led Ip68 12Mm Out 10Mm In 2Pin



LM2080
Controlador Regulador Led Monocolor/cct



LM2082
Controlador Regulador Smarthome Led Monocolor/cct



LM2084
Controlador Regulador Monocolor+Cct 12/24V Dc + Mando Rf



LM2087
Mando Rf Para Regulador Led Monocolor 4 Zonas

LED strip Serie Clasic 120 Led/m - 5 Metros



LIGHT SOURCE:
Smd 3535
FINISH:
PCB Blanco / White
ANGLE:
120°
WORKING TIME:
-20°C + 45°C
DURABILITY:
30000 Hr
POWER SUPPLY:
24V DC
MATERIAL:
PC
CRI:
80

REF	SIZE	W	CUT	IP	WAVELENGTH / BRIGHTNESS	°K
LM2417	10X5000 mm	12 W/M	5 CM	IP20	R-620-630/ G510-525 / B455-470 nm	RGB
LM2447	10X5000 mm	12 W/M	5 CM	IP65	R-620-630/ G510-525 / B455-470 nm	RGB



Includes 3M Self-adhesive

Compatible accessories:



LM2081
Controlador Regulador Led Rgb/rgbw/rgb+Cct



LM2083
Controlador Regulador Smarthome Led Rgb/rgbw/rgb+Cct



LM2919
Conector de Hipopotamo L Para Tira Led Ip65 10Mm 4Pin



LM2911
Conector de Hipopotamo Para Tira Led y Cable Ip65 10Mm 4Pin



LM2912
Conector de Hipopotamo Para Tira Led Ip65 10Mm 4Pin



LM42182
Dimmer Empotrable Táctil Rgb Para Tiras Led 12/24V



LM2187
Controlador Mini Smarthome Para Tiras Led Rgb Con Control Remoto Por Ir / App



LM2087
Mando Rf Regulador Led Monocolor 4 Zonas



LM2085
Controlador Regulador Rgb+Cct 12/24V Dc + Mando Rf



LM2088
Mando Rf Regulador Led Rgb+Cct 4 Zonas

LED strip Clasic 120 Led/m RGB - 20 Metros



LIGHT SOURCE:
Smd 3535
FINISH:
PCB Blanco / White
ANGLE:
120°
WORKING TIME:
-20°C + 45°C
DURABILITY:
30000 Hr
POWER SUPPLY:
24V DC
MATERIAL:
PC
CRI:
80

REF	SIZE	W	CUT	IP	WAVELENGTH / BRIGHTNESS	°K
LM2469	8X20000 mm	12 W/M	4 CM	IP65	R-620-630/ G510-525 / B455-470 nm	RGB



Includes
3M
Self-adhesive

Compatible accessories:



LM2081
Controlador Regulador
Led Rgb/rgbw/rgb+Cct



LM2083
Controlador Regulador
Smarthome Led
Rgb/rgbw/rgb+Cct



LM2088
Mando Rf Regulador Led
Rgb+Cct 4 Zonas



LM2085
Controlador Regulador
Rgb+Cct 12/24V Dc +
Mando Rf

LED strip Clasic 120 Led/m - 5 Metros



LIGHT SOURCE:
Smd 3535
FINISH:
PCB Blanco / White
ANGLE:
120°
WORKING TIME:
-20°C + 50°C
DURABILITY:
30000 Hr
POWER SUPPLY:
24V DC
MATERIAL:
PC
CRI:
80

REF	SIZE	W	CUT	IP	WAVELENGTH / BRIGHTNESS	°K
LM2411	8X5000 mm	12 W/M	5 CM	IP20	1200 LM/W	6000 K
LM2412	8X5000 mm	12 W/M	5 CM	IP20	1200 LM/W	4000 K
LM2413	8X5000 mm	12 W/M	5 CM	IP20	1200 LM/W	2700 K
LM2414	8X5000 mm	12 W/M	5 CM	IP20	1200 LM/W	Red
LM2415	8X5000 mm	12 W/M	5 CM	IP20	1200 LM/W	Blue
LM2416	8X5000 mm	12 W/M	5 CM	IP20	1200 LM/W	Green



Compatible accessories:



LM2181
Dimmer Empotrable
Táctil Monocolor Para
Tiras Led 12/24V



LM2268
Amplificador de Señal
12-24V



LM2930
Conector Ultramini Para
Tira 8Mm 12V/24
Monocolor



LM2931
Conector Ultramini
Para Tira 8Mm 12V/24V
Monocolor A Cable de
2 Hilos



LM2080
Controlador Regulador
Led Monocolor/cct



LM2082
Controlador Regulador
Smarthome Led
Monocolor/cct



LM2084
Controlador Regulador
Monocolor+Cct 12/24V
Dc + Mando Rf



LM2087
Mando Rf Regulador Led
Monocolor 4 Zonas

LED strip Videny 60 Led/m - 5 Metros



LIGHT SOURCE:
Smd 5050
FINISH:
PCB Blanco / White
ANGLE:
120°
WORKING TIME:
-20°C + 45°C
DURABILITY:
30000 Hr
POWER SUPPLY:
24V DC
MATERIAL:
PC
CRI:
80

REF	SIZE	W	CUT	IP	WAVELENGTH / BRIGHTNESS	°K
LM2134	10X5000 mm	14 W/M	10 CM	IP20	R-620-630/ G510-525 / B455-470 nm	RGB
LM2226	10X5000 mm	14 W/M	10 CM	IP65	R-620-630/ G510-525 / B455-470 nm	RGB



Includes
3M
Self-adhesive

Compatible accessories:



LM2182
Dimmer Empotrable Táctil Rgb Para Tiras Led 12/24V



LM2269
Amplificador de Señal Rgb 12-24V



LM2081
Controlador Regulador Led Rgb/rgbw/rgb+Cct



LM2083
Controlador Regulador Smarthome Led Rgb/rgbw/rgb+Cct



LM2919
Conector de Hipopótamo L Para Tira Led Ip65 10Mm 4Pin



LM2088
Mando Rf Regulador Led Rgb+Cct 4 Zonas



LM2911
Conector de Hipopótamo Para Tira Led y Cable Ip65 10Mm 4Pin



LM2912
Conector de Hipopótamo Para Tira Led Ip65 10Mm 4Pin



LM2085
Controlador Regulador Rgb+Cct 12/24V Dc + Mando Rf

LED strip Ziadna 240 Led/m - 5 Metros



LIGHT SOURCE:
Smd 2835
FINISH:
PCB Blanco / White
ANGLE:
120°
WORKING TIME:
-20°C + 50°C
DURABILITY:
50000 Hr
POWER SUPPLY:
24V DC
MATERIAL:
PC
CRI:
90

REF	SIZE	W	CUT	IP	WAVELENGTH / BRIGHTNESS	°K
LM2801	10X5000 mm	18,5 W/M	2,5 CM	IP20	1800 LM/M	6000 K
LM2802	10X5000 mm	18,5 W/M	2,5 CM	IP20	1800 LM/M	4000 K
LM2803	10X5000 mm	18,5 W/M	2,5 CM	IP20	1800 LM/M	2700 K
LM2804	10X5000 mm	18,5 W/M	2,5 CM	IP65	1800 LM/M	6000 K
LM2805	10X5000 mm	18,5 W/M	2,5 CM	IP65	1800 LM/M	4000 K
LM2806	10X5000 mm	18,5 W/M	2,5 CM	IP65	1800 LM/M	2700 K



Includes
3M
Self-adhesive

Compatible accessories:



LM2930
Conector Ultramini Para Tira 8Mm 12V/24 Monocolor



LM2931
Conector Ultramini Para Tira 8Mm 12V/24 Monocolor A Cable de 2 Hilos



LM2080
Controlador Regulador Led Monocolor/cct



LM2082
Controlador Regulador Smarthome Led Monocolor/cct



LM2084
Controlador Regulador Monocolor+Cct 12/24V Dc + Mando Rf



LM2087
Mando Rf Regulador Led Monocolor 4 Zonas



LM2905
Conector de Hipopótamo Para Tira Led y Cable Ip65 8Mm 2Pin



LM2906
Conector de Hipopótamo Para Tira Led Ip65 8Mm 2Pin

LED strip Ziadna 120 Led/m - 5 Metros



LIGHT SOURCE:
Smd 2835
FINISH:
PCB Blanco / White
ANGLE:
120°
WORKING TIME:
-20°C + 45°C
DURABILITY:
50000 Hr
POWER SUPPLY:
24V DC
MATERIAL:
PC
CRI:
80

REF	SIZE	W	CUT	IP	WAVELENGTH / BRIGHTNESS	°K
LM2135	8X5000 mm	9 W/M	5 CM	IP20	800 LM/M	6000 K
LM2136	8X5000 mm	9 W/M	5 CM	IP20	800 LM/M	4500 K
LM2137	8X5000 mm	9 W/M	5 CM	IP20	800 LM/M	3000 K
LM2223	8X5000 mm	9 W/M	5 CM	IP65	800 LM/M	6000 K
LM2224	8X5000 mm	9 W/M	5 CM	IP65	800 LM/M	4500 K
LM2225	8X5000 mm	9 W/M	5 CM	IP65	800 LM/M	3000 K
LM2701	8X5000 mm	5 W/M	5 CM	IP20	500 LM/M	6000 K
LM2702	8X5000 mm	5 W/M	5 CM	IP20	500 LM/M	4500 K
LM2703	8X5000 mm	5 W/M	5 CM	IP20	500 LM/M	3000 K



5 M



Includes
3M
Self-adhesive

Compatible accessories:



LM2080
Controlador Regulador Led Monocolor/cct



LM2082
Controlador Regulador Smarthome Led Monocolor/cct



LM2084
Controlador Regulador Monocolor+Cct 12/24V Dc + Mando Rf



LM2087
Mando Rf Regulador Led Monocolor 4 Zonas



LM2181
Dimmer Empotrable Táctil Monocolor Para Tiras Led 12/24V



LM2268
Amplificador de Señal 12-24V



LM2930
Conector Ultramini Para Tira 8Mm 12V/24 Monocolor



LM2931
Conector Ultramini Para Tira 8Mm 12V/24V Monocolor A Cable de 2 Hilos



LM2905
Conector de Hipopótamo Para Tira Led y Cable Ip65 8Mm 2Pin



LM2906
Conector de Hipopótamo Para Tira Led Ip65 8Mm 2Pin

LED strip Ziadna 204 Led/m - 5 Metros



LIGHT SOURCE:
Smd 2835
FINISH:
PCB Blanco / White
ANGLE:
120°
WORKING TIME:
-20°C + 45°C
DURABILITY:
50000 Hr
POWER SUPPLY:
24V DC
MATERIAL:
PC
CRI:
80

REF	SIZE	W	CUT	IP	WAVELENGTH / BRIGHTNESS	°K
LM2065	10X5000 mm	18,5 W/M	3 CM	IP20	1600 LM/M	6000 K
LM2066	10X5000 mm	18,5 W/M	3 CM	IP20	1600 LM/M	4000 K
LM2067	10X5000 mm	18,5 W/M	3 CM	IP20	1600 LM/M	3000 K



5 M



Includes
3M
Self-adhesive

Compatible accessories:



LM2181
Dimmer Empotrable Táctil Monocolor Para Tiras Led 12/24V



LM2268
Amplificador de Señal 12-24V



LM2930
Conector Ultramini Para Tira 8Mm 12V/24 Monocolor



LM2931
Conector Ultramini Para Tira 8Mm 12V/24V Monocolor A Cable de 2 Hilos



LM2080
Controlador Regulador Led Monocolor/cct



LM2082
Controlador Regulador Smarthome Led Monocolor/cct



LM2084
Controlador Regulador Monocolor+Cct 12/24V Dc + Mando Rf



LM2087
Mando Rf Regulador Led Monocolor 4 Zonas

LED strip Videny 60 Led/m - 5 Metros



LIGHT SOURCE:
Smd 5050
FINISH:
PCB Blanco / White
ANGLE:
120°
WORKING TIME:
-20°C + 45°C
DURABILITY:
50000 Hr
POWER SUPPLY:
24V DC
MATERIAL:
PC
CRI:
80

REF	SIZE	W	CUT	IP	WAVELENGTH / BRIGHTNESS	°K
LM2131	10X5000 mm	14 W/M	10 CM	IP20	1400 LMM	6000 K
LM2132	10X5000 mm	14 W/M	10 CM	IP20	1400 LMM	4500 K
LM2133	10X5000 mm	14 W/M	10 CM	IP20	1400 LMM	3000 K



Compatible accessories:



LM2181
Dimmer Empotrable Táctil Monocolor Para Tiras Led 12/24V



LM2268
Amplificador de Señal 12-24V



LM2080
Controlador Regulator Led Monocolor/cct



LM2082
Controlador Regulator Smarthome Led Monocolor/cct



LM2084
Controlador Regulator Monocolor+Cct 12/24V Dc + Mando Rf



LM2087
Mando Rf Regulator Led Monocolor 4 Zonas

LED strip Ziadna 120 Led/m - 20 Metros



LIGHT SOURCE:
Smd 2835
FINISH:
PCB Blanco / White
ANGLE:
120°
WORKING TIME:
-20°C + 45°C
DURABILITY:
30000 Hr
POWER SUPPLY:
24V DC
MATERIAL:
PC
CRI:
80

REF	SIZE	W	CUT	IP	WAVELENGTH / BRIGHTNESS	°K
LM2421	10X20000 mm	12 W/M	4 CM	IP20	100 LMM	6000 K
LM2422	10X20000 mm	12 W/M	4 CM	IP20	100 LMM	4500 K
LM2423	10X20000 mm	12 W/M	4 CM	IP20	100 LMM	2700 K
LM2427	10X20000 mm	12 W/M	4 CM	IP65	100 LMM	6000 K
LM2428	10X20000 mm	12 W/M	4 CM	IP65	100 LMM	4000 K
LM2429	10X20000 mm	12 W/M	4 CM	IP65	100 LMM	2700 K



Compatible accessories:



LM2080
Controlador Regulator Led Monocolor/cct



LM2082
Controlador Regulator Smarthome Led Monocolor/cct



LM2084
Controlador Regulator Monocolor+Cct 12/24V Dc + Mando Rf



LM2087
Mando Rf Regulator Led Monocolor 4 Zonas

LED strip Serie Clasic RGB 204 Led/m - 5 Metros



LIGHT SOURCE:
Smd 3535
FINISH:
PCB Blanco / White
ANGLE:
120°
WORKING TIME:
-20°C + 45°C
DURABILITY:
30000 Hr
POWER SUPPLY:
24V DC
MATERIAL:
PC
CRI:
80

REF	SIZE	W	CUT	IP	WAVELENGTH / BRIGHTNESS	°K
LM2398	10X5000 mm	25 W/M	3 CM	IP20	R-620-630/ G510-525 / B455-470 nm	RGB



Compatible accessories:



LM2081
Controlador Regulador Led Rgb/rgbw/rgb+Cct



LM2083
Controlador Regulador Smarthome Led Rgb/rgbw/rgb+Cct



LM2088
Mando Rf Regulador Led Rgb+Cct 4 Zonas



LM2085
Controlador Regulador Rgb+Cct 12/24V Dc + Mando Rf

LED strip Serie Letters 120 Led/m - 5 Metros



LIGHT SOURCE:
Smd 2835
FINISH:
PCB Blanco / White
ANGLE:
120°
WORKING TIME:
-20°C + 50°C
DURABILITY:
50000 Hr
POWER SUPPLY:
24V DC
MATERIAL:
PC
CRI:
80

REF	SIZE	W	CUT	IP	WAVELENGTH / BRIGHTNESS	°K
LM2461	8X5000 mm	14 W/M	8 MM	IP20	1400 LM/M	6000 K
LM2462	8X5000 mm	14 W/M	8 MM	IP20	1400 LM/M	4000 K
LM2463	8X5000 mm	14 W/M	8 MM	IP20	1400 LM/M	2700 K
LM2464	8X5000 mm	14 W/M	8 MM	IP20	1400 LM/M	2300 K
LM2465	8X5000 mm	14 W/M	8 MM	IP20	1400 LM/M	Red
LM2466	8X5000 mm	14 W/M	8 MM	IP20	1400 LM/M	Blue
LM2467	8X5000 mm	14 W/M	8 MM	IP20	1400 LM/M	Green
LM2468	8X5000 mm	14 W/M	8 MM	IP20	1400 LM/M	Pink



Includes 3M Self-adhesive

Compatible accessories:



LM2080
Controlador Regulador Led Monocolor/cct



LM2082
Controlador Regulador Smarthome Led Monocolor/cct



LM2084
Controlador Regulador Monocolor+Cct 12/24V Dc + Mando Rf



LM2087
Mando Rf Regulador Led Monocolor 4 Zonas

LED strip Half (5Mm de Ancho) - 5 Metros



LIGHT SOURCE:
Smd 2835
FINISH:
PCB Blanco / White
ANGLE:
120°
WORKING TIME:
-20°C + 45°C
DURABILITY:
50000 Hr
POWER SUPPLY:
24V DC
MATERIAL:
PC
CRI:
80

REF	SIZE	W	CUT	IP	WAVELENGTH / BRIGHTNESS	°K
LM2214	4X5000 mm	9 W/M	5 CM	IP20	900 LM/M	6000 K
LM2215	4X5000 mm	9 W/M	5 CM	IP20	900 LM/M	4000 K
LM2216	4X5000 mm	9 W/M	5 CM	IP20	900 LM/M	3000 K



Compatible accessories:



LM2181
Dimmer Empotrable Táctil Monocolor Para Tiras Led 12/24V



LM2268
Amplificador de Señal 12-24V



LM2080
Controlador Regulador Led Monocolor/cct



LM2082
Controlador Regulador Smarthome Led Monocolor/cct



LM2084
Controlador Regulador Monocolor+Cct 12/24V Dc + Mando Rf



LM2087
Mando Rf Regulador Led Monocolor 4 Zonas

LED strip Cobled Naked 576 Led/m RGB - 5 Metros



LIGHT SOURCE:
Cob
FINISH:
PCB Blanco / White
ANGLE:
120°
WORKING TIME:
-20°C + 45°C
DURABILITY:
30000 Hr
POWER SUPPLY:
24V DC
MATERIAL:
PC
CRI:
80

REF	SIZE	W	CUT	IP	WAVELENGTH / BRIGHTNESS	°K
LM2471	10X5000 mm	15 W/M	3 CM	IP20	R-620-630/ G510-525 / B455-470 nm	RGB
LM2472	10X5000 mm	15 W/M	3 CM	IP65	R-620-630/ G510-525 / B455-470 nm	RGB



Includes 3M Self-adhesive

Compatible accessories:



LM2081
Controlador Regulador Led Rgb/rgbw/rgb+Cct



LM2083
Controlador Regulador Smarthome Led Rgb/rgbw/rgb+Cct



LM2088
Mando Rf Regulador Led Rgb+Cct 4 Zonas



LM2085
Controlador Regulador Rgb+Cct 12/24V Dc + Mando Rf

LED strip Cobled Nake 320 Led/m - 5 Metros



LIGHT SOURCE:
Cob
FINISH:
PCB Blanco / White
ANGLE:
120°
WORKING TIME:
-20°C + 45°C
DURABILITY:
30000 Hr
POWER SUPPLY:
24V DC
MATERIAL:
PC
CRI:
80

REF	SIZE	W	CUT	IP	WAVELENGTH / BRIGHTNESS	°K
LM2811	8X5000 mm	11 W/M	5 CM	IP20	1100 LMM	6000 K
LM2812	8X5000 mm	11 W/M	5 CM	IP20	1100 LMM	4000 K
LM2813	8X5000 mm	11 W/M	5 CM	IP20	1100 LMM	3000 K



Includes
3M
Self-adhesive

Compatible accessories:



LM2080
Controlador Regulador
Led Monocolor/cct



LM2082
Controlador Regulador
Smarthome Led Mono-
color/cct



LM2084
Controlador Regulador
Monocolor+Cct 12/24V
Dc + Mando Rf



LM2087
Mando Rf Regulador Led
Monocolor 4 Zonas

LED strip Cobmaori 256 Led/m - 5 Metros



LIGHT SOURCE:
Cob
FINISH:
PCB Blanco / White
ANGLE:
120°
WORKING TIME:
-20°C + 45°C
DURABILITY:
50000 Hr
POWER SUPPLY:
24V DC
MATERIAL:
PC
CRI:
80

REF	SIZE	W	CUT	IP	WAVELENGTH / BRIGHTNESS	°K
LM2821	8X5000 mm	14 W/M	5 CM	IP20	1560 LMM	10000 K
LM2822	8X5000 mm	14 W/M	5 CM	IP20	1560 LMM	6500 K
LM2823	8X5000 mm	14 W/M	5 CM	IP20	1560 LMM	4000 K
LM2824	8X5000 mm	14 W/M	5 CM	IP20	1560 LMM	3000 K
LM2825	8X5000 mm	14 W/M	5 CM	IP20	1560 LMM	Red
LM2826	8X5000 mm	14 W/M	5 CM	IP20	1560 LMM	Green
LM2827	8X5000 mm	14 W/M	5 CM	IP20	1560 LMM	Blue
LM2828	8X5000 mm	14 W/M	5 CM	IP20	1560 LMM	Blue Ice
LM2829	8X5000 mm	14 W/M	5 CM	IP20	1560 LMM	Gold
LM2830	8X5000 mm	14 W/M	5 CM	IP20	1560 LMM	Pink



Includes
3M
Self-adhesive

Compatible accessories:



LM2080
Controlador Regulador
Led Monocolor/cct



LM2082
Controlador Regulador
Smarthome Led Mono-
color/cct



LM2084
Controlador Regulador
Monocolor+Cct 12/24V
Dc + Mando Rf



LM2087
Mando Rf Regulador Led
Monocolor 4 Zonas

LED strip Videny 96 Led/m - 5 Metros



LIGHT SOURCE:
Smd 5050
FINISH:
PCB Blanco / White
ANGLE:
120°
WORKING TIME:
-20°C + 45°C
DURABILITY:
30000 Hr
POWER SUPPLY:
24V DC
MATERIAL:
PC
CRI:
80

REF	SIZE	W	CUT	IP	WAVELENGTH / BRIGHTNESS	°K
LM2379	10X5000 mm	12 W/M	10 CM	IP20	R-620-630/ G510-525 / B455-470 nm	RGB
LM2380	10X5000 mm	12 W/M	6 CM	IP65	R-620-630/ G510-525 / B455-470 nm	RGB



Includes 3M Self-adhesive

Compatible accessories:



LM2081
Controlador Regulador Led Rgb/rgbw/rgb+Cct



LM2083
Controlador Regulador Smarthome Led Rgb/rgbw/rgb+Cct



LM2088
Mando Rf Regulador Led Rgb+Cct 4 Zonas



LM2085
Controlador Regulador Rgb+Cct 12/24V Dc + Mando Rf



LM2182
Dimmer Empotrable Táctil Rgb Para Tiras Led 12/24V



LM2269
Amplificador de Señal Rgb 12-24V



LM2187
Controlador Mini Smart-home Para Tiras Led Rgb Con Control Remoto Por Ir / App



LM2918
Conector de Hipópótamo L Para Tira Led Ip20 10Mm 4Pin

LED strip Classic Ip20 RGB+CCT 168 Led/m - 5 Metros



LIGHT SOURCE:
Smd 3535 + 2835
FINISH:
PCB Blanco / White
ANGLE:
120°
WORKING TIME:
-20°C + 45°C
DURABILITY:
30000 Hr
POWER SUPPLY:
24V DC
MATERIAL:
PC
CRI:
80

REF	SIZE	W	CUT	IP	WAVELENGTH / BRIGHTNESS	°K
LM2473	12X5000 mm	14 W/M	10 CM	IP20	R-620-630/ G510-525 / B455-470 nm - 1200 LM/W	RGB+CCT



Compatible accessories:



LM2081
Controlador Regulador Led Rgb/rgbw/rgb+Cct



LM2083
Controlador Regulador Smarthome Led Rgb/rgbw/rgb+Cct



LM2085
Controlador Regulador Rgb+Cct 12/24V Dc + Mando Rf



LM2088
Mando Rf Para Regulador Led Rgb+Cct 4 Zonas

LED strip Videny RGB+C (6000 K) 60 Led/m - 5 Metros



LIGHT SOURCE:
Smd 5050
FINISH:
PCB Blanco / White
ANGLE:
120°
WORKING TIME:
-20°C + 45°C
DURABILITY:
30000 Hr
POWER SUPPLY:
24V DC
MATERIAL:
PC
CRI:
80

REF	SIZE	W	CUT	IP	WAVELENGTH / BRIGHTNESS	*K
LM2451	12X5000 mm	14 W/M	10 CM	IP20	R-620-630/ G510-525 / B455-470 nm - 960 LM/M	RGB+C
LM2452	12X5000 mm	14 W/M	10 CM	IP65	R-620-630/ G510-525 / B455-470 nm - 960 LM/M	RGB+C



Includes
3M
Self-adhesive

Compatible accessories:



LM2081
Controlador Regulador Led Rgb/rgbw/rgb+Cct



LM2083
Controlador Regulador Smarthome Led Rgb/rgbw/rgb+Cct



LM2088
Mando Rf Regulador Led Rgb+Cct 4 Zonas



LM2085
Controlador Regulador Rgb+Cct 12/24V Dc + Mando Rf



LM2913
Conector de Hipopótamo Para Tira Led y Cable Ip65 12Mm 5Pin



LM2914
Conector de Hipopótamo Para Tira Led Ip65 12Mm 5Pin

LED strip Videny RGB+W (3000 K) 60 Led/m - 5 Metros



LIGHT SOURCE:
Smd 5050
FINISH:
PCB Blanco / White
ANGLE:
120°
WORKING TIME:
-20°C + 45°C
DURABILITY:
30000 Hr
POWER SUPPLY:
24V DC
MATERIAL:
PC
CRI:
80

REF	SIZE	W	CUT	IP	WAVELENGTH / BRIGHTNESS	*K
LM2453	12X5000 mm	14 W/M	10 CM	IP20	R-620-630/ G510-525 / B455-470 nm - 960 LMM	RGB+W
LM2454	12X5000 mm	14 W/M	10 CM	IP65	R-620-630/ G510-525 / B455-470 nm - 960 LMM	RGB+W



Includes
3M
Self-adhesive

Compatible accessories:



LM2081
Controlador Regulador Led Rgb/rgbw/rgb+Cct



LM2083
Controlador Regulador Smarthome Led Rgb/rgbw/rgb+Cct



LM2088
Mando Rf Regulador Led Rgb+Cct 4 Zonas



LM2085
Controlador Regulador Rgb+Cct 12/24V Dc + Mando Rf



LM2913
Conector de Hipopótamo Para Tira Led y Cable Ip65 12Mm 5Pin



LM2914
Conector de Hipopótamo Para Tira Led Ip65 12Mm 5Pin

LED strip Videny RGB+CCT 60 Led/m - 5 Metros



LIGHT SOURCE:
Smd 5050
FINISH:
PCB Blanco / White
ANGLE:
120°
WORKING TIME:
-20°C + 45°C
DURABILITY:
30000 Hr
POWER SUPPLY:
24V DC
MATERIAL:
PC
CRI:
80

REF	SIZE	W	CUT	IP	WAVELENGTH / BRIGHTNESS	°K
LM2455	12X5000 mm	15 W/M	10 CM	IP20	R-620-630/ G510-525 / B455-470 nm	RGB+CCT
LM2456	12X5000 mm	15 W/M	10 CM	IP65	R-620-630/ G510-525 / B455-470 nm	RGB+CCT



Includes
3M
Self-adhesive

Compatible accessories:



LM2081
Controlador Regulador Led Rgb/rgbw/rgb+Cct



LM2083
Controlador Regulador Smarthome Led Rgb/rgbw/rgb+Cct



LM2088
Mando Rf Regulador Led Rgb+Cct 4 Zonas



LM2085
Controlador Regulador Rgb+Cct 12/24V Dc + Mando Rf



LM2915
Conector de Hipopótamo Para Tira Led y Cable Ip65 12Mm 6Pin



LM2912
Conector de Hipopótamo Para Tira Led Ip65 12Mm 6Pin

LED strip Ziadna 240 Led/m - 5 Metros



LIGHT SOURCE:
Smd 2835
FINISH:
PCB Blanco / White
ANGLE:
120°
WORKING TIME:
-20°C ~ +45°C
DURABILITY:
50000 Hr
POWER SUPPLY:
24V DC
MATERIAL:
PC
CRI:
80

REF	SIZE	W	CUT	IP	WAVELENGTH / BRIGHTNESS	°K
LM2376	15X5000 mm	20 W/M	5 CM	IP20	2000 LMM	6000 K
LM2377	15X5000 mm	20 W/M	5 CM	IP20	2000 LMM	4500 K
LM2378	15X5000 mm	20 W/M	5 CM	IP20	2000 LMM	3000 K



Compatible accessories:



LM2181
Dimmer Empotrable Táctil Monocolor Para Tiras Led 12/24V



LM2268
Amplificador de Señal 12-24V



LM2080
Controlador Regulador Led Monocolor/cct



LM2082
Controlador Regulador Smarthome Led Monocolor/cct



LM2084
Controlador Regulador Monocolor+Cct 12/24V Dc + Mando Rf

LED strip Ziadna CCT 192 Led/m - 5 Metros



LIGHT SOURCE:
Smd 2835
FINISH:
PCB Blanco / White
ANGLE:
120°
WORKING TIME:
-20°C ~ +45°C
DURABILITY:
50000 Hr
POWER SUPPLY:
24V DC
MATERIAL:
PC
CRI:
80

REF	SIZE	W	CUT	IP	WAVELENGTH / BRIGHTNESS	°K
LM2019	10X5000 mm	14 W/M	6 CM	IP20	1500 LM/M	CCT



Compatible accessories:



LM2080
Controlador Regulador Led Monocolor/cct



LM2082
Controlador Regulador Smarthome Led Monocolor/cct



LM2084
Controlador Regulador Monocolor+Cct 12/24V Dc + Mando Rf



LM2088
Mando Rf Regulador Led Rgb+Cct 4 Zonas



LM2903
Conector de Hipopotamo Para Tira Led y Cable Ip20 10Mm 3Pin



LM2910
Conector de Hipopotamo Para Tira Led Ip65 10Mm 3Pin



LM2188
Controlador Mini Para Tiras Led Cct Con Control Remoto Por Ir





LIGHT SOURCE:
Smd 2835
FINISH:
Transparente
ANGLE:
120°
DURABILITY:
30000 Hr
POWER SUPPLY:
185-265V AC
MATERIAL:
Metal/PC
CRI:
70

REF	SIZE	W	IP	WAVELENGTH / BRIGHTNESS	°K
LM6237	1100X35X10 mm	12	IP20	980	6000 K
LM6238	1100X35X10 mm	12	IP20	980	4500 K



Barra LED Para Estanterías

Transforma tus espacios con la iluminación LED de nuestra Barra LED para Estanterías. Con un diseño elegante y funcional, esta barra LED está diseñada para brindar una iluminación óptima a tus estanterías, resaltando cada detalle de tus objetos expuestos.

Potencia Brillante: Con 980 lúmenes y solo 12 vatios de consumo, nuestra Barra LED ofrece una iluminación potente y eficiente energéticamente, que realza el aspecto de tus estanterías sin comprometer tu factura de electricidad.

Temperatura de COLOR: Disponible en dos opciones de temperatura de COLOR: 4500 K para una iluminación más cálida y acogedora, ideal para ambientes residenciales, y 6000 K para una luz más nítida y brillante, perfecta para entornos comerciales y de exhibición.

CRI: Con un CRI de 70, nuestra Barra LED garantiza que los Colores se representen con precisión y fidelidad, lo que te permite apreciar cada detalle.

SMD 2835: Equipada con tecnología SMD 2835, nuestra barra LED proporciona una distribución uniforme de la luz.

Aplicaciones: Ya sea que estés exhibiendo libros en una biblioteca, productos en una tienda minorista o elementos decorativos en tu hogar, nuestra Barra LED para Estanterías es la solución perfecta para resaltar tus objetos con una iluminación uniforme y de alta calidad.

Instalación: Diseñada para una instalación sin complicaciones, nuestra Barra LED para estanterías se monta fácilmente.

Transform your spaces with the LED lighting of our LED Shelf Bar. With a stylish and functional design, this LED bar is designed to provide optimal lighting for your shelves, highlighting every detail of your exhibits.

Bright Power: With 980 lumens and only 12 watts of power consumption, our LED Shelf Bar offers powerful, energy-efficient lighting that enhances the look of your shelves without compromising your electricity bill.

Colour Temperature: Available in two colour temperature options: 4500 K for warmer, cosier lighting, ideal for residential environments, and 6000 K for crisper, brighter light, perfect for commercial and display environments.

CRI: With a CRI of 70, our LED Bar ensures colours are accurately and faithfully rendered, allowing you to appreciate every detail.

SMD 2835: Equipped with SMD 2835 technology, our LED Bar provides an even distribution of light.

Applications: Whether you're displaying books in a library, products in a retail shop or decorative items in your home, our LED Shelf Bar is the perfect solution to highlight your objects with uniform, high quality illumination.

Installation: Designed for hassle-free installation, our LED Shelf Bar is easy to assemble.

LED strip Half 6.5 Mm - 50 Metros



LIGHT SOURCE:
Smd 2025
FINISH:
Transparente
ANGLE:
120°
WORKING TIME:
-20°C + 45°C
DURABILITY:
50000 Hr
POWER SUPPLY:
170-265V AC
MATERIAL:
Silicone / PC / Epoxi
CRI:
80
DIMMABLE:
Triac

REF	SIZE	W	CUT	IP	WAVELENGTH / BRIGHTNESS	°K
LM2621	6,5X3H mm	12 W/M	10 CM	IP65	950 LM/M	6000 K
LM2622	6,5X3H mm	12 W/M	10 CM	IP65	950 LM/M	4000 K
LM2623	6,5X3H mm	12 W/M	10 CM	IP65	950 LM/M	2700 K
LM2624	6,5X3H mm	12 W/M	10 CM	IP65	950 LM/M	2100 K



Compatible accessories:

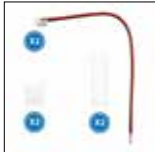

LM2625
Cable Adaptador Para
Tira Led 220Vac Half

LED strip Prostrip - 50 Metros



LIGHT SOURCE:
Smd 2835
FINISH:
Transparente
ANGLE:
120°
WORKING TIME:
-20°C + 45°C
DURABILITY:
50000 Hr
POWER SUPPLY:
170-265V AC
MATERIAL:
Silicone / PC / Epoxi
CRI:
90
DIMMABLE:
Triac

REF	SIZE	W	CUT	IP	WAVELENGTH / BRIGHTNESS	°K
LM2611	10X3H mm	12 W/M	10 CM	IP65	1000 LM/M	6000 K
LM2612	10X3H mm	12 W/M	10 CM	IP65	1000 LM/M	4000 K
LM2613	10X3H mm	12 W/M	10 CM	IP65	1000 LM/M	2700 K
LM2614	10X3H mm	12 W/M	10 CM	IP65	1000 LM/M	2100 K



Compatible accessories:

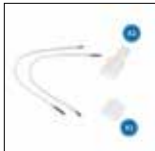

LM2615
Cable Adaptador Para
Tira Led 220Vac Prostrip

LED strip Cobpoint - 50 Metros



LIGHT SOURCE:
Cob
FINISH:
Transparente
ANGLE:
120°
WORKING TIME:
-20°C + 45°C
DURABILITY:
30000 Hr
POWER SUPPLY:
170-265V AC
MATERIAL:
Silicone / PC / Epoxi
CRI:
80

REF	SIZE	W	CUT	IP	WAVELENGTH / BRIGHTNESS	°K
LM2021	10X5 mm	15 W/M	4,5 m	IP65	840 LM/M	6000 K
LM2022	10X5 mm	15 W/M	4,5 m	IP65	840 LM/M	4000 K
LM2023	10X5 mm	15 W/M	4,5 m	IP65	840 LM/M	2700 K
LM2024	10X5 mm	15 W/M	4,5 m	IP65	840 LM/M	2100 K



Compatible accessories:



LM2923
Conector de Inicio Para Tira Led Ip68 10Mm Out 8Mm In 2Pin



LM2924
Conector Intermedio Con Cable Para Tira Led Ip68 10Mm Out 8Mm In 2Pin



LM2922
Conector Intermedio Para Tira Led Ip68 10Mm Out 8Mm In 2Pin



LM2340
Cable Adaptador Crimpable Para Tira Led 220Vac Cobpro

LED strip Ruzok - 20 Metros



LIGHT SOURCE:
Smd 2835
FINISH:
Transparente
ANGLE:
120°
WORKING TIME:
-20°C + 45°C
DURABILITY:
50000 Hr
POWER SUPPLY:
170-265V AC
MATERIAL:
Silicone / PC / Epoxi
CRI:
90
DIMMABLE:
Triac

REF	SIZE	W	CUT	IP	WAVELENGTH / BRIGHTNESS	°K
LM2163	12X5H mm	17 W/M	10 CM	IP67	1680 LM/M	6000 K
LM2164	12X5H mm	17 W/M	10 CM	IP67	1680 LM/M	4500 K
LM2165	12X5H mm	17 W/M	10 CM	IP67	1680 LM/M	3000 K



Compatible accessories:



LM0005
Conector de Inicio Para Tira Led Ip68 12Mm Out 10Mm In 2Pin



LM2926
Conector de Inicio Para Tira Led Ip68 10Mm Out 8Mm In 2Pin



LM2927
Conector Intermedio Con Cable Para Tira Led Ip68 12Mm Out 10Mm In 2Pin



LM2925
Conector Intermedio Para Tira Led Ip68 12Mm Out 10Mm In 2Pin

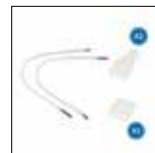

LM0004
Cable Adaptador Para Tira Led 220Vac Ruzok

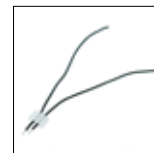

LM0001
Cable Adaptador Para Tira Led 220Vac Ruzok



LM2359
Cable Adaptador Para Tira Led 220Vac Ruzok / Brescia



LM2038
Cable Adaptador Crimpable Para Tira Led 220Vac Ruzok



LM0015
Rectificador Free Flicker Para Tiras Led



LM2359A
Cable Adaptador Para Tira Led 220Vac Ruzok / Brescia 500Mm

LED strip Brescia - 20 Metros



LIGHT SOURCE:
Smd 2835
FINISH:
Transparente
ANGLE:
120°
WORKING TIME:
-20°C + 45°C
DURABILITY:
30000 H
POWER SUPPLY:
170-265V AC
MATERIAL:
Silicone / PC / Epoxi
CRI:
80
DIMMABLE:
Triac

REF	SIZE	W	CUT	IP	WAVELENGTH / BRIGHTNESS	°K
LM2341	12X5H mm	12 W/M	10 CM	IP67	1560 LM/M	6000 K
LM2342	12X5H mm	12 W/M	10 CM	IP67	1560 LM/M	4000 K
LM2343	12X5H mm	12 W/M	10 CM	IP67	1560 LM/M	3000 K
LM2344	12X5H mm	12 W/M	10 CM	IP67	1560 LM/M	2300 K



Compatible accessories:



LM0005
Conector de Inicio Para Tira Led Ip68 12Mm Out 10Mm In 2Pin



LM2926
Conector de Inicio Para Tira Led Ip68 10Mm Out 8Mm In 2Pin



LM2927
Conector Intermedio Con Cable Para Tira Led Ip68 12Mm Out 10Mm In 2Pin



LM2925
Conector Intermedio Para Tira Led Ip68 12Mm Out 10Mm In 2Pin

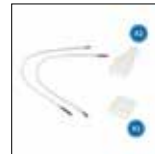

LM0004
Cable Adaptador Para Tira Led 220Vac Ruzok

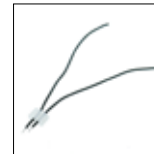

LM0001
Cable Adaptador Para Tira Led 220Vac Ruzok



LM2359
Cable Adaptador Para Tira Led 220Vac Ruzok / Brescia



LM2038
Cable Adaptador Crimpable Para Tira Led 220Vac Ruzok



LM0015
Rectificador Free Flicker Para Tiras Led



LM2359A
Cable Adaptador Para Tira Led 220Vac Ruzok / Brescia 500Mm

LED strip Fast RGB - 50 Metros



LIGHT SOURCE:
Smd 2835
FINISH:
Transparente
ANGLE:
120°
WORKING TIME:
-20°C + 45°C
DURABILITY:
30000 H
POWER SUPPLY:
170-265V AC
MATERIAL:
Silicone / PC / Epoxi
CRI:
80
DIMMABLE:
Triac

REF	SIZE	W	CUT	IP	WAVELENGTH / BRIGHTNESS	°K
LM2301	15X6 mm	14 W/M	1 m	IP65	1440 LM/M	6000 K
LM2302	15X6 mm	14 W/M	1 m	IP65	1440 LM/M	4500 K
LM2303	15X6 mm	14 W/M	1 m	IP65	1440 LM/M	3000 K
LM2304	15X6 mm	14 W/M	1 m	IP65	1440 LM/M	2300 K
LM2305	15X6 mm	14 W/M	1 m	IP65	R-620-630	Red
LM2306	15X6 mm	14 W/M	1 m	IP65	B455-470 nm	Blue
LM2307	15X6 mm	14 W/M	1 m	IP65	R-620-630/ G510-525 / B455-470 nm	Pink
LM2308	15X6 mm	14 W/M	1 m	IP65	G510-525	Green
LM2309	15X6 mm	14 W/M	1 m	IP65	R-620-630/ G510-525 / B455-470 nm	RGB



Compatible accessories:



LM3052
Perfil de Pc Fast 2 Metros



LM2058A
Tapón Para Tira Led 220Vac Rozok/ Fast



LM2058
Grapa Tira Led 220Vac Rozok / Fast



LM2310
Rectificador Tira Led 220V Smd 2835 Fast 14,4W/m

LED strip Bergamo - 50 Metros



LIGHT SOURCE:
Smd 2835
FINISH:
Transparente
ANGLE:
120°
WORKING TIME:
-20°C + 45°C
DURABILITY:
50000 H
POWER SUPPLY:
170-265V AC
MATERIAL:
Silicone / PC / Epoxi
CRI:
80
DIMMABLE:
Triac

REF	SIZE	W	CUT	IP	WAVELENGTH / BRIGHTNESS	°K
LM2331	10X3H mm	17 W/M	10 CM	IP65	1500 LM/M	6000 K
LM2332	10X3H mm	17 W/M	10 CM	IP65	1500 LM/M	4500 K
LM2333	10X3H mm	17 W/M	10 CM	IP65	1500 LM/M	2700 K
LM2345	10X3H mm	12 W/M	10 CM	IP65	1000 LM/M	6000 K
LM2346	10X3H mm	12 W/M	10 CM	IP65	1000 LM/M	4000 K
LM2347	10X3H mm	12 W/M	10 CM	IP65	1000 LM/M	3000 K
LM2348	10X3H mm	12 W/M	10 CM	IP65	1000 LM/M	2300 K
LM2349	10X3H mm	12 W/M	10 CM	IP65	1000 LM/M	2700 K
LM2334	12X3H mm	13 W/M	12,5 CM	IP65	R-620-630/ G510-525 / B455-470 nm	RGB



LM2334



Compatible accessories:



LM0005
Conector de Inicio Para Tira Led Ip68 12Mm Out 10Mm In 2Pin



LM2926
Conector de Inicio Para Tira Led Ip68 10Mm Out 8Mm In 2Pin



LM2927
Conector Intermedio Con Cable Para Tira Led Ip68 12Mm Out 10Mm In 2Pin



LM2925
Conector Intermedio Para Tira Led Ip68 12Mm Out 10Mm In 2Pin

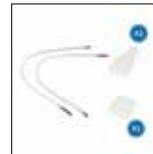

LM0004
Cable Adaptador Para Tira Led 220Vac Ruzok

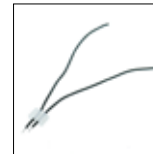

LM0001
Cable Adaptador Para Tira Led 220Vac Ruzok



LM2358
Cable Adaptador Para Tira Led 220Vac Bergamo



LM2038
Cable Adaptador Crimpable Para Tira Led 220Vac Ruzok



LM0015
Rectificador Free Flicker Para Tiras Led

LED strip Como - 50 Metros



LIGHT SOURCE:
Smd 2835
FINISH:
Transparente
ANGLE:
120°
WORKING TIME:
-20°C + 45°C
DURABILITY:
30000 H
POWER SUPPLY:
170-265V AC
MATERIAL:
Silicone / PC / Epoxi
CRI:
80
DIMMABLE:
Triac

REF	SIZE	W	CUT	IP	WAVELENGTH / BRIGHTNESS	°K
LM2351	14X6H mm	12 W/M	10 CM	IP65	1400 LM/M	6000 K
LM2352	14X6H mm	12 W/M	10 CM	IP65	1400 LM/M	4000 K
LM2353	14X6H mm	12 W/M	10 CM	IP65	1400 LM/M	3000 K
LM2354	14X6H mm	12 W/M	10 CM	IP65	1400 LM/M	2300 K



110 LED/M

Compatible accessories:



LM2357
Cable Adaptador Crimpable Para Tira Led 220Vac Como

LED strip Arast - 50 Metros



LIGHT SOURCE:
Smd 2835
FINISH:
Opal
ANGLE:
120°
WORKING TIME:
-20°C + 45°C
DURABILITY:
30000 H
POWER SUPPLY:
220-240V AC
MATERIAL:
Silicone / PC / Epoxi
CRI:
80
DIMMABLE:
Triac

REF	SIZE	W	CUT	IP	WAVELENGTH / BRIGHTNESS	°K
LM2314	17X8 mm	14 W/M	1 m	IP65	1584 LM/M	6000 K
LM2315	17X8 mm	14 W/M	1 m	IP65	1584 LM/M	4500 K



Compatible accessories:



LM2313
Kit de Conversion de Emergencia Hasta 20W

LED Neon Flexible Prozny RGB - 50 Metros



LIGHT SOURCE:
Smd 2835
FINISH:
Opal
ANGLE:
180°
WORKING TIME:
-20°C + 45°C
DURABILITY:
30000 H
POWER SUPPLY:
170-265V AC
MATERIAL:
Silicone / PC / Epoxi
CRI:
80

REF	SIZE	W	CUT	IP	WAVELENGTH / BRIGHTNESS	°K
LM2157	26X14 mm	8,5 W/M	1 m	IP65	R-620-630/ G510-525 / B455-470 nm	RGB



Compatible accessories:



LM2161
Controlador Para Neón Led Rgb 220V Con Mando



LM2160
Controlador Neón Led Rgb 220V 8.5W/m



LM2271
Receptor Para Tiras Led Rgbw Rf 220V



LM2272
Controlador Para Tiras Led Rgbw Rf 220V

LED Neon Flexible Prozny - 50 Metros



LIGHT SOURCE:
Smd 2835
FINISH:
Opal
ANGLE:
180°
WORKING TIME:
-20°C + 45°C
DURABILITY:
30000 H
POWER SUPPLY:
170-265V AC
MATERIAL:
Silicone / PC / Epoxi
CRI:
80

REF	SIZE	W	CUT	IP	WAVELENGTH / BRIGHTNESS	°K
LM2150	18X8 mm	8,5 W/M	1 m	IP65	800 LMM	3000 K
LM2151	18X8 mm	8,5 W/M	1 m	IP65	800 LMM	4500 K
LM2152	18X8 mm	8,5 W/M	1 m	IP65	800 LMM	6000 K
LM2153	18X8 mm	8,5 W/M	1 m	IP65	800 LMM	Blue
LM2154	18X8 mm	8,5 W/M	1 m	IP65	800 LMM	Red
LM2155	18X8 mm	8,5 W/M	1 m	IP65	800 LMM	Green



Compatible accessories:



LM2158
Rectificador Neón Led
220V 8.5W/m Monocolor

LED Neon Flexible Proline - 50 Metros



LIGHT SOURCE:
Smd 2835
FINISH:
Opal
ANGLE:
120°
WORKING TIME:
-20°C + 45°C
DURABILITY:
30000 H
POWER SUPPLY:
200-240V AC
MATERIAL:
Silicone / PC / Epoxi
CRI:
90
DIMMABLE:
Triac

REF	SIZE	W	CUT	IP	WAVELENGTH / BRIGHTNESS	°K
LM2601	10X10H mm	12 W/M	10 cm	IP65	960 LMM	6000 K
LM2602	10X10H mm	12 W/M	10 cm	IP65	960 LMM	4000 K
LM2603	10X10H mm	12 W/M	10 cm	IP65	960 LMM	2700 K
LM2604	10X10H mm	12 W/M	10 cm	IP65	960 LMM	2100 K



Compatible accessories:



LM3978
Perfil Flexible de
Aluminio 10X7H Mm
Para Neones O Funda
de Silicone - 20 Metros

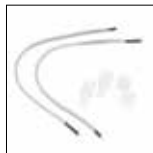

LM2605
Cable Adaptador Para
Neon Led 220Vac Proline

LED Neon Flexible Letters - 50 Metros



LIGHT SOURCE:
Smd 2835
FINISH:
Opal
ANGLE:
120°
WORKING TIME:
-20°C + 45°C
DURABILITY:
30000 H
POWER SUPPLY:
12V DC
MATERIAL:
PC
CRI:
80

REF	SIZE	W	CUT	IP	WAVELENGTH / BRIGHTNESS	°K
LM2481	5000X5X12H mm	14 W/M	1 cm	IP65	1200 LM/M	6000 K
LM2482	5000X5X12H mm	14 W/M	1 cm	IP65	1200 LM/M	4000 K
LM2483	5000X5X12H mm	14 W/M	1 cm	IP65	1200 LM/M	2700 K
LM2484	5000X5X12H mm	14 W/M	1 cm	IP65	R-620-630	Red
LM2485	5000X5X12H mm	14 W/M	1 cm	IP65	G510-525	Green
LM2486	5000X5X12H mm	14 W/M	1 cm	IP65	B455-470 nm	Blue
LM2487	5000X5X12H mm	14 W/M	1 cm	IP65	P380-410	Purple
LM2488	5000X5X12H mm	14 W/M	1 cm	IP65	P	Pink
LM2489	5000X5X12H mm	14 W/M	1 cm	IP65	G590-610	Gold
LM2490	5000X5X12H mm	14 W/M	1 cm	IP65	O610-630	Orange
LM2491	5000X6X12H mm	14 W/M	3 cm	IP65	R-620-630/ G510-525 / B455-470 nm	RGB



Compatible accessories:



LM0042
Pack Tapón Inicio y Final
Neón de Led Flexible
12Vdc Letters



LM3049
Perfil de Pc Slim
2 Metros

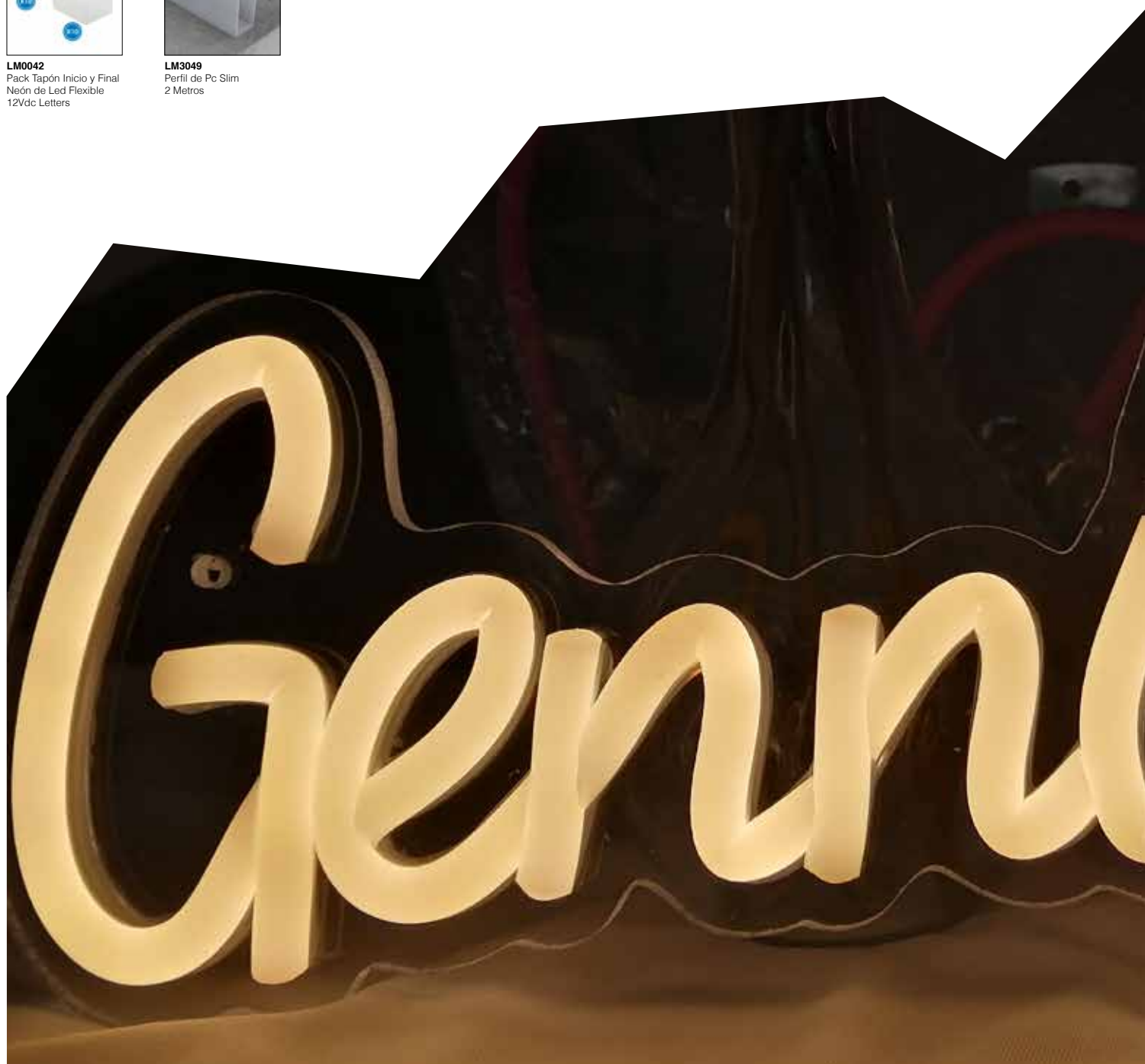



Slim 8X4 Silicone Cover for LED Strips - 20 Meters



REF	SIZE	ANGLE	IP	FINISH	MATERIAL
LM3985	4X8H mm	180°	IP67	Opal	Silicone

Rectangular 15X8 Silicone Cover for LED Strips - 20 Meter



REF	SIZE	ANGLE	IP	FINISH	MATERIAL
LM3979	8X15H mm	180°	IP67	Opal	Silicone

Recessed Silicone Cover for Led Strips - 20 Meters



REF	SIZE	ANGLE	IP	FINISH	MATERIAL
LM3971	14X9H mm	180°	IP67	Opal	Silicone

Slim Silicone Covers for LED Strips



Cube Silicone Cover for LED Strips - 20 Meters



REF	SIZE	ANGLE	IP	FINISH	MATERIAL
LM3973	12X12H mm	180°	IP67	Opal	Silicone
LM3975	15X15H mm	180°	IP67	Opal	Silicone

Cylinder 20X20 Silicone Cover for LED Strips - 20 Meters



REF	SIZE	ANGLE	IP	FINISH	MATERIAL
LM3981	20X20H mm	180°	IP67	Opal	Silicone

Cylinder 22X10 Silicone Arc for LED Strips - 20 Meters



REF	SIZE	ANGLE	IP	FINISH	MATERIAL
LM3977	20X10H mm	180°	IP67	Opal	Silicone

Drop 13X6 Silicone Cover for LED Strips - 20 Meters



REF	SIZE	ANGLE	IP	FINISH	MATERIAL
LM3983	13X6H mm	180°	IP67	Opal	Silicone

Door 15X15 Silicone Cover for LED Strips - 20 Meters



REF	SIZE	ANGLE	IP	FINISH	MATERIAL
LM3982	15X15H mm	180°	IP67	Opal	Silicone

Silicone Cover for Next Generation LED Strips





REF	SIZE	ANGLE	IP	FINISH	COLOR	MATERIAL
LM2631	8X10H mm	180°	IP20	Opal	Blanco	Silicone
LM2632	8X10H mm	180°	IP20	Opal	Pink	Silicone
LM2633	8X10H mm	180°	IP20	Opal	Purple	Silicone
LM2634	8X10H mm	180°	IP20	Opal	Blue	Silicone
LM2635	8X10H mm	180°	IP20	Opal	Light blue	Silicone
LM2636	8X10H mm	180°	IP20	Opal	Green	Silicone
LM2637	8X10H mm	180°	IP20	Opal	Red	Silicone
LM2638	8X10H mm	180°	IP20	Opal	Amarillo	Silicone
LM2639	8X10H mm	180°	IP20	Opal	Gold	Silicone
LM2640	8X10H mm	180°	IP20	Opal	Orange	Silicone
LM2641	8X10H mm	180°	IP20	Opal	Light green	Silicone

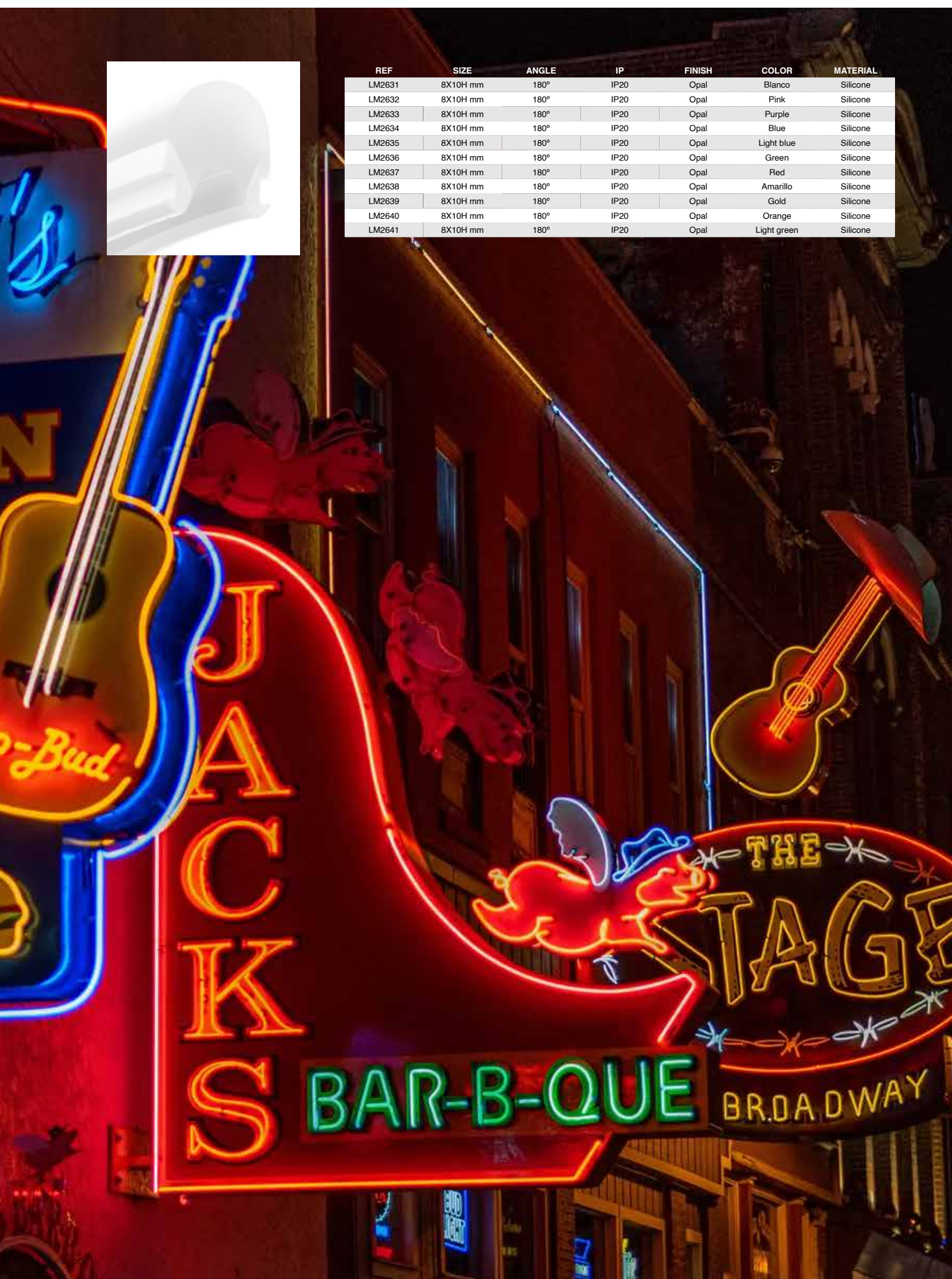

IP
IP20

MATERIAL
Aluminium

POWER SUPPLY
170-265V AC

POWER FACTOR
≥0.5

WORKING TEMP
-20°C + 45°C

REF	SIZE	W	VOLTAGE	IP
Lrs-35-12	99X82X30H mm	35	12	IP20
Lrs-75-12	99X97X30H mm	75	12	IP20
Lrs-100-12	129X97X30H mm	100	12	IP20
Lrs-150-12	159X97X30H mm	150	12	IP20
Lrs-200-12	215X115X30H mm	200	12	IP20
Lrs-350-12	215X115X30H mm	350	12	IP20
Lrs-15-24	62,5X51x28H mm	15	24	IP20
Lrs-35-24	99X82X30H mm	35	24	IP20
Lrs-75-24	99X97X30H mm	75	24	IP20
Lrs-100-24	129X97X30H mm	100	24	IP20
Lrs-150-24	159X97X30H mm	150	24	IP20
Lrs-200-24	215X115X30H mm	200	24	IP20
Lrs-350-24	215X115X30H mm	350	24	IP20



Power Supplies Mean Well



IP

IP20

MATERIAL

Aluminium

POWER SUPPLY

200-240V AC

POWER FACTOR

>0.8

WORKING TEMP

-20°C + 65°C

REF	SIZE	W	VOLTAGE	IP
LM2521	190X50X29H mm	60	12	IP20
LM2522	230X50X29H mm	100	12	IP20
LM2523	300X48X29H mm	150	12	IP20
LM2524	300X48X29H mm	200	12	IP20
LM2525	190X50X29H mm	60	24	IP20
LM2526	230X50X29H mm	100	24	IP20
LM2527	300X48X29H mm	150	24	IP20
LM2528	300X48X29H mm	200	24	IP20



0-10V Dimmable Power Supplies



Power Supplies for 24V IP66 LED Strips

IP

IP66

MATERIAL

PC

POWER SUPPLY

170-265V AC

POWER FACTOR

0.55

WORKING TEMP

-40°C ~ +50°C

REF	SIZE	W	VOLTAGE	IP
LM2532	162X43X31H mm	60	24	IP66
LM2533	190X62X38H mm	100	24	IP66
LM2534	190X62X38H mm	150	24	IP66
LM2529	190X62X38H mm	60	12	IP66
LM2530	190X62X38H mm	100	12	IP66
LM2531	190X62X38H mm	150	12	IP66

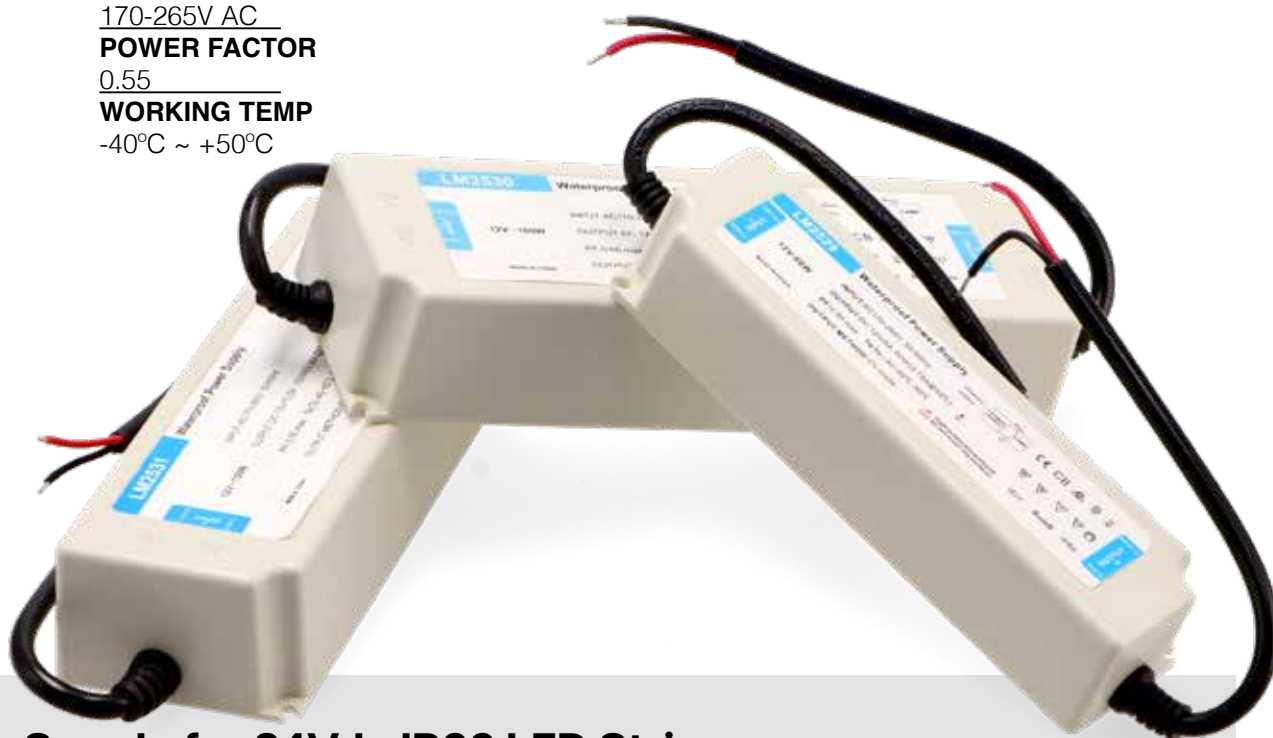

Power Supply for 24Vdc IP66 LED Strips

Presentamos nuestras fuentes de alimentación de 24 V, la solución perfecta para iluminar tu entorno con eficiencia y estilo. Diseñadas para satisfacer tus necesidades de iluminación, estas fuentes de alimentación destacan por su rendimiento excepcional y durabilidad.

Potencias Versátiles: Tres potencias diferentes **60W, 100W y 150W**. Esto te permite adaptar la iluminación según tus requerimientos específicos, brindándote flexibilidad y eficiencia energética.

Robustez en su Construcción: Fabricadas en policarbonato (PC), estas fuentes de alimentación garantizan resistencia y durabilidad. El MATERIAL de alta calidad asegura la protección contra impactos y condiciones ambientales adversas, asegurando un rendimiento confiable a lo largo del tiempo.

Protección Certificada: Con un grado de protección **IP66**, nuestras fuentes de alimentación son resistentes al polvo y al agua, proporcionando una solución confiable para entornos exteriores e interiores.

Eficiencia Energética: Nuestras fuentes de alimentación cuentan con un factor de potencia de **0.55**, lo que significa un uso eficiente de la energía.

Ya sea para proyectos residenciales, comerciales o industriales, estas fuentes de alimentación ofrecen un rendimiento excepcional y una durabilidad inigualable. Ilumina tu espacio con confianza y estilo, elige nuestras fuentes de alimentación de calidad superior.

Introducing our 24V power supplies, the perfect solution for lighting your environment with efficiency and style. Designed to meet your lighting needs, these power supplies stand out for their exceptional performance and durability.

Versatile Wattages: Three different wattages 60W, 100W and 150W. This allows you to tailor the lighting to your specific requirements, giving you flexibility and energy efficiency.

Robust Construction: Manufactured from polycarbonate (PC), these power supplies guarantee strength and durability. The high quality MATERIAL ensures protection against impact and harsh environmental conditions, ensuring reliable performance over time.

Certified Protection: With an IP66 rating, our power supplies are dust and water resistant, providing a reliable solution for outdoor and indoor environments.

Energy Efficiency: Our power supplies feature a power factor of 0.55, which means efficient use of energy.

Whether for residential, commercial or industrial projects, these power supplies offer exceptional performance and unmatched durability. Light up your space with confidence and style, choose our premium quality power supplies.

Mean Well IP67 Power Supplies for LED Strips

IP

IP67

MATERIAL

PC

POWER SUPPLY

90-264V AC

POWER FACTOR

0.55

WORKING TEMP

-30°C ~ +70°C

REF	SIZE	W	VOLTAGE	IP
LPV-60-12	162X42,5X32 mm	60	24	IP66
LPV-100-12	190X52X37 mm	100	24	IP66
LPV-150-12	191X63X375 mm	150	24	IP66
LPV-60-24	162X42,5X32 mm	60	24	IP66
LPV-100-24	190X52X37 mm	100	24	IP66
LPV-150-24	191X63X375 mm	150	24	IP66

5 YEARS
WARRANTY

Mean Well IP67 Power Supplies for LED Strips

Diseñadas para brindar un rendimiento excepcional y una durabilidad incomparable, estas fuentes de alimentación son la opción ideal para una variedad de aplicaciones de iluminación.

Potencias: Disponibles en tres potencias diferentes: **60W, 100W y 150W**. Esta variedad te permite adaptar la iluminación según tus necesidades específicas, brindándote flexibilidad y eficiencia energética en cada proyecto.

Construcción Resistente: Fabricadas en policarbonato (**PC**), nuestras fuentes de alimentación ofrecen una resistencia excepcional a los impactos y a las condiciones ambientales adversas. Esto garantiza un rendimiento confiable incluso en entornos exigentes.

Protección Certificada: Con un grado de protección **IP67**, nuestras fuentes de alimentación están completamente selladas contra el polvo y protegidas contra la inmersión temporal en agua.

Eficiencia Energética: Nuestras fuentes de alimentación cuentan con un factor de potencia de **0.55**, lo que garantiza un uso eficiente de la energía.

En resumen, nuestras fuentes de alimentación de 12 V son la elección perfecta para cualquier proyecto de iluminación que requiera rendimiento, durabilidad y eficiencia energética. Confía en nuestra calidad superior para iluminar tus espacios de manera segura y efectiva.

Designed for exceptional performance and unmatched durability, these power supplies are the ideal choice for a variety of lighting applications.

Wattages: Available in three different wattages: 60W, 100W and 150W. This variety allows you to tailor your lighting to your specific needs, giving you flexibility and energy efficiency for every project.

Resistant construction: Made of polycarbonate (PC), our power supplies offer exceptional resistance to impact and harsh environmental conditions. This ensures reliable performance even in demanding environments.

Certified Protection: With an IP67 rating, our power supplies are completely sealed against dust and protected against temporary immersion in water.

Energy Efficiency: Our power supplies feature a power factor of 0.55, ensuring efficient power usage.

In short, our 12V power supplies are the perfect choice for any lighting project that requires performance, durability and energy efficiency. Rely on our superior quality to illuminate your spaces safely and effectively.

Dimmable Triac Power Supply 24V

IP
IP20

MATERIAL

Aluminium

POWER SUPPLY

200-240V AC

POWER FACTOR

0.9

WORKING TEMP

-40°C ~ +50°C

DIMMABLE

Triac

REF	SIZE	W	VOLTAGE	IP
LM2106	230X49X29H mm	80	24	IP20
LM2107	288X49X29H mm	150	24	IP20



Dimmable Triac Power Supply 24V

Presentamos nuestras fuentes de alimentación de 24 V, diseñadas para ofrecer un rendimiento excepcional y una iluminación óptima en cualquier entorno.

Potencias: Disponibles en dos potencias diferentes **80W y 150W**. Esta variedad te brinda la flexibilidad necesaria para adaptar la iluminación a tus necesidades específicas, ya sea en aplicaciones residenciales, comerciales o industriales.

Construcción: Fabricadas en aluminio de alta calidad, nuestras fuentes de alimentación ofrecen durabilidad y resistencia excepcionales. El diseño robusto garantiza una disipación eficiente del calor, lo que prolonga la vida útil del producto.

Regulación TRIAC: Equipadas con regulación **TRIAC**, nuestras fuentes de alimentación permiten un control preciso del nivel de iluminación. Esto te brinda la capacidad de ajustar la intensidad de la luz según tus preferencias y requisitos específicos.

Factor de potencia: Con un factor de potencia de **0.9**, nuestras fuentes de alimentación garantizan un uso eficiente de la energía eléctrica. Esto no solo reduce el consumo de energía, sino que también contribuye a un funcionamiento más sostenible.

Elección ideal para aquellos que buscan una iluminación de calidad superior y un rendimiento excepcional. Confía en nuestra experiencia y calidad para iluminar tus espacios con eficiencia y estilo.

Introducing our 24V power supplies, designed to deliver exceptional performance and optimum illumination in any environment.

Power ratings: Available in two different wattages 80W and 150W. This variety gives you the flexibility to tailor your lighting to your specific needs, whether in residential, commercial or industrial applications.

Construction: Manufactured from high quality aluminium, our power supplies offer exceptional durability and strength. The robust design ensures efficient heat dissipation, which prolongs the life of the product.

TRIAC dimming: Equipped with TRIAC dimming, our power supplies allow precise control of the lighting level. This gives you the ability to adjust the light intensity according to your specific preferences and requirements.

POWER FACTOR: With a power factor of 0.9, our power supplies ensure efficient use of electrical energy. This not only reduces energy consumption, but also contributes to more sustainable operation.

Ideal choice for those looking for superior lighting quality and exceptional performance. Trust our experience and quality to illuminate your spaces with efficiency and style.

Power Supply for 24V IP65 LED Strips

IP

IP65

MATERIAL

Aluminium

POWER SUPPLY

200-240V AC

POWER FACTOR

0.8

OUTPUT

24V

WORKING TEMP

-20°C ~ +60°C

REF	SIZE	W	VOLTAGE	IP
LM2510	102X36X21H mm	36	24	IP65
LM2513	167X53X20H mm	120	24	IP65
LM2515	193X65X29H mm	200	24	IP65
LM2516	193X65X29H mm	250	24	IP65
LM2517	203X70X42H mm	300	24	IP65
LM2518	223X70X40H mm	400	24	IP65
LM2501	102X36X21H mm	36	12	IP65
LM2504	167X53X20H mm	120	12	IP65
LM2506	193X65X29H mm	200	12	IP65
LM2507	193X65X29H mm	250	12	IP65
LM2508	203X70X42H mm	300	12	IP65
LM2509	223X70X40H mm	400	12	IP65



Power Supply for 24V IP65 LED Strips

Solución confiable y eficiente para una amplia gama de aplicaciones de iluminación y electrónica. Fabricadas con los más altos estándares de calidad y diseñadas para un rendimiento óptimo, estas fuentes de alimentación son ideales.

Construcción: Nuestras fuentes de alimentación están fabricadas en aluminio de alta calidad, lo que garantiza una excelente disipación del calor y una durabilidad excepcional.

IP65: Resistente al polvo y al agua, lo que lo hace adecuado para uso en exteriores y en entornos donde pueda estar expuesto a condiciones adversas como lluvia o humedad.

Factor de Potenci: Nuestras fuentes de alimentación cuentan con un factor de potencia de **0.8**, lo que garantiza una eficiencia energética óptima y un uso eficiente de la energía eléctrica.

Potencias: Con potencias disponibles desde **36W hasta 400W**, nuestras fuentes de alimentación ofrecen una solución versátil para una variedad de aplicaciones.

Con una construcción robusta, un alto factor de potencia y una amplia gama de potencias disponibles, estas fuentes de alimentación proporcionan la energía estable y segura que tu proyecto necesita.

Reliable and efficient solution for a wide range of lighting and electronics applications. Manufactured to the highest quality standards and designed for optimum performance, these power supplies are ideal.

Construction: Our power supplies are manufactured from high quality aluminium, ensuring excellent heat dissipation and exceptional durability.

IP20: With an IP20 rating, these power supplies offer protection against solid objects larger than 12.5mm and do not provide protection against water.

POWER FACTOR: Our power supplies have a power factor of 0.8, ensuring optimum energy efficiency and efficient use of electrical energy.

Power ratings: With power ratings available from 36W to 400W, our power supplies offer a versatile solution for a variety of applications.

With a robust construction, high power factor and a wide range of available wattages, these power supplies provide the stable and secure power your project needs.

IP

IP25

MATERIAL

Aluminium

POWER SUPPLY

220-240V AC

POWER FACTOR

>0.5

WORKING TEMP

-30°C + 60°C

REF	SIZE	W	VOLTAGE	IP
LM2244	144X53X21H mm	60	12	IP25
LM2245	160X53X21H mm	100	12	IP25
LM2246	185X58X28H mm	200	12	IP25
LM2247	159X97X30H mm	300	12	IP25
LM2248	215X115X30H mm	400	12	IP25
LM2251	144X53X21H mm	60	24	IP25
LM2252	160X53X21H mm	100	24	IP25
LM2253	185X58X28H mm	200	24	IP25
LM2254	159X97X30H mm	300	24	IP25
LM2255	215X115X30H mm	400	24	IP25



Slim Power Supplies for LED Strips



Power Supply for LED Strips (Special for Profiles)



IP:
IP20
POWER SUPPLY:
180-260V AC
MATERIAL:
Aluminium
POWER FACTOR:
>0.5

REF	SIZE	VOLTAGE	W
LM2242	172X18X18H mm	12	15
LM2258	290X13X13H mm	12	60
LM2260	290X13X13H mm	24	72



Input: 180-260V AC
 Output: DC24V 3A 72W
 Recommended load: 4.72W/m @ 65°C
Fuente De Alimentacion
 24V 3A
 Model: LM2260
 CE, RoHS, REACH, Energy Star, ENEC



234.
Recessed 360° PIR
Motion Sensor



234.
Motion Detector PIR 360°
Recessed



234.
Detector de movimiento
PIR 180° Superficie



234.
PIR Motion Detector 180°
Surface-Mounted



235.
Detector de Movimiento
PIR Square 160°



235.
Square PIR Motion
Detector 160°



235.
Infrared Motion Detector
360° Surface-Mounted



235.
PIR Motion Detector 180°
Surface-Mounted



Detectores de Presencia



Motion
Sensors

Detectores de Presencia - Presence Detectors

www.ledme-europa.com

Recessed 360° PIR Motion Sensor



IP:
IP20
POWER SUPPLY:
220-240V ac
MAX POWER:
300
MATERIAL:
PC Ignifugo
DURABILITY:
30000 Hr
DETECTION ANGLE:
360°
DETECTION DISTANCE:
6 metros
TIME MIN/MAX:
10 seg - 7 min
REGULATION TIME:
Modo Día / Noche

REF	SIZE	CUT	COLOR
LM9016	74X80H mm	60 mm	Blanco / White
LM9017	74X80H mm	60 mm	Blanco / White / Gris / Grey



Detectores de Presencia - Presence Detectors

www.ledme-europa.com

Motion Detector PIR 360° Recessed



IP:
IP20
POWER SUPPLY:
220-240V ac
MAX POWER:
100
MATERIAL:
PC Ignifugo
DURABILITY:
30000 Hr
DETECTION ANGLE:
360°
DETECTION DISTANCE:
6 metros
TIME MIN/MAX:
10 seg - 2 min
REGULATION TIME:
Modo Día / Noche

REF	SIZE	COLOR
LM9014	22X26H mm	Blanco / White



Detectores de Presencia - Presence Detectors

www.ledme-europa.com

Detector de movimiento PIR 180° Superficie



IP:
IP44
POWER SUPPLY:
220-240V ac
MAX POWER:
1200
MATERIAL:
PC Ignifugo
DURABILITY:
30000 Hr
DETECTION ANGLE:
180°
DETECTION DISTANCE:
12 metros
TIME MIN/MAX:
10 seg - 7 min
REGULATION TIME:
Modo Día / Noche

REF	SIZE	COLOR
LM8275	100X95 mm	Blanco / White
LM8276	100X95 mm	Negro / Black



Detectores de Presencia - Presence Detectors

www.ledme-europa.com

PIR Motion Detector 180° Surface-Mounted



IP:
IP44
POWER SUPPLY:
220-240V ac
MAX POWER:
1200
MATERIAL:
PC Ignifugo
DURABILITY:
30000 Hr
DETECTION ANGLE:
180°
DETECTION DISTANCE:
12 metros
TIME MIN/MAX:
10 seg - 7 min
REGULATION TIME:
Modo Día / Noche

REF	SIZE	COLOR
LM8277	130X120 mm	Blanco / White
LM8278	130X120 mm	Negro / Black



Detectores de Presencia - Presence Detectors

www.ledme-europa.com

Detector de Movimiento PIR Square 160°



IP:
IP20
POWER SUPPLY:
220-240V ac
MAX POWER:
300
MATERIAL:
PC Ignifugo
DURABILITY:
30000 Hr
DETECTION ANGLE:
160°
DETECTION DISTANCE:
9 metros
TIME MIN/MAX:
10 seg - 2 min
REGULATION TIME:
Modo Día / Noche

REF	SIZE	COLOR
LM9012	75X20H mm	Blanco / White



Detectores de Presencia - Presence Detectors

www.ledme-europa.com

Square PIR Motion Detector 160°



IP:
IP20
POWER SUPPLY:
220-240V ac
MAX POWER:
100
MATERIAL:
PC
DURABILITY:
30000 Hr
DETECTION ANGLE:
360°
DETECTION DISTANCE:
6 metros
TIME MIN/MAX:
10 seg - 2 min
REGULATION TIME:
Modo Día / Noche

REF	Potencia	SIZE	COLOR
LM9011	25	75X20H mm	Blanco / White



Detectores de Presencia - Presence Detectors

www.ledme-europa.com

Infrared Motion Detector 360° Surface-Mounted



IP:
IP20
POWER SUPPLY:
220-240V ac
MAX POWER:
300
MATERIAL:
PC Ignifugo
DURABILITY:
30000 Hr
DETECTION ANGLE:
360°
DETECTION DISTANCE:
6 metros
TIME MIN/MAX:
10 seg - 2 min
REGULATION TIME:
Modo Día / Noche

REF	SIZE	COLOR
LM9015	115X55H mm	Blanco / White



Detectores de Presencia - Presence Detectors

www.ledme-europa.com

PIR Motion Detector 180° Surface-Mounted



IP:
IP20
POWER SUPPLY:
220-240V ac
MAX POWER:
300
MATERIAL:
PC Ignifugo
DURABILITY:
30000 Hr
DETECTION ANGLE:
180°
DETECTION DISTANCE:
12 metros
TIME MIN/MAX:
10 seg - 7 min
REGULATION TIME:
Modo Día / Noche

REF	SIZE	COLOR
LM9013	86,5X60X97,5H mm	Blanco / White





238.
Emergency Conversion
Kit 20-50W



239.
Emergency Conversion
Kit 20-50W



240.
Emergency Conversion
Kit up to 50W
LF-GSP012YG



241.
DALI 2-Wire to 1-10V
Converter Gateway for
Industrial Lighting IP67
LF-SCD010B



242.
LED Surfled Flashlight
with Hook and Magnet
IP65 + Power Bank
Function 6000K



243.
LED Dimmer 0-10V



243.
Extractor Hadary 15W



243.
Surge Protector 10kV
SOSEN



243.
Extractor Hadary 15W



244.
Extractor Ofair 60X60
cm 50W



244.
Extractor Hadary 14W



244.
Quick connector with 3
inputs for up to 4 mm²



244.
Clip-on terminal block
with 3-pole quick
connection



245.
BisaLight LED



245.
Feather Multifunction
LED Flashlight with
Magnet IP65

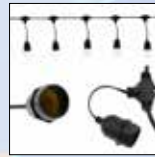

246.
String of 10 E27 Sockets
Outdoor Ip65 Electric
Cable



248.
LED projector bracket



248.
Wall Mount for LED
Streetlights



248.
Articulated Arm for
Streetlight 180°

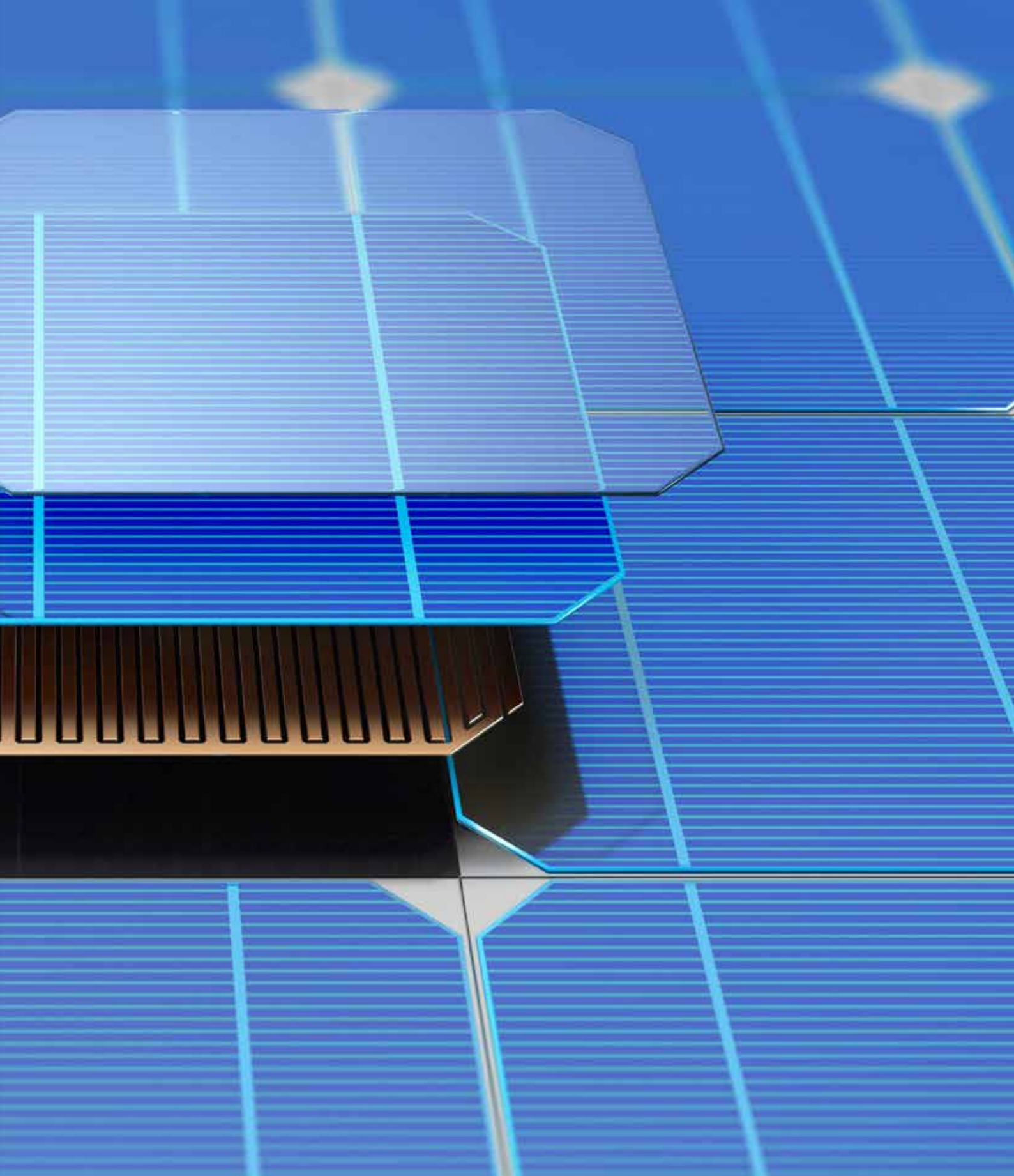

Electrical
Materials



IP:
 IP30
POWER SUPPLY:
 85-265V AC
POWER MAX:
 20 a 50
MATERIAL:
 Termoplastico / PC
WORKING TEMP:
 0°C + 50°C
CHARGE TIME:
 24 Hr
USE TIME:
 180 min

REF	SIZE	COLOR
LM2129	213X40X28H mm	White



20-50W Emergency Conversion Kit

El Kit de Conversión de Emergencia 20-50W es la solución perfecta para garantizar una W máxima de 20 a 50, asegurando así un suministro eléctrico confiable en situaciones críticas. Con su protección IP30, este kit ofrece una resistencia óptima a los elementos externos, evitando daños y asegurando un rendimiento duradero.

Equipado con una batería de alta capacidad de **11.1V** y **2600 mAh**, este kit proporciona una fuente de energía confiable y duradera. Su tiempo de carga de **24 horas** asegura una carga completa para un uso prolongado y sin interrupciones. Una vez cargado, el tiempo de uso de **180 minutos** garantiza una autonomía suficiente para hacer frente a cualquier situación de emergencia.

Este kit de conversión de emergencia es ideal para diversas aplicaciones, como iluminación de emergencia, sistemas de seguridad, equipos de comunicación y muchos otros dispositivos de baja W. Con su tono informativo, queremos destacar la importancia de contar con una solución confiable y eficiente en situaciones de emergencia.

No pierdas la oportunidad de obtener el **Kit de Conversión de Emergencia 20-50W** y asegúrate de tener la W necesaria para afrontar cualquier situación imprevista. No comprometas tu seguridad y confía en la calidad y eficiencia de nuestro producto.

¡No esperes más y adquiere tu kit ahora mismo!

The 20-50W Emergency Conversion Kit is the perfect solution to guarantee a maximum W of 20-50W, ensuring a reliable power supply in critical situations. With its IP30 protection, this kit offers optimal resistance to external elements, preventing damage and ensuring long-lasting performance.

Equipped with a high capacity 11.1V, 2600 mAh battery, this kit provides a reliable and long-lasting power source. Its 24-hour charging time ensures a full charge for prolonged, uninterrupted use. Once charged, the 180-minute usage time ensures sufficient autonomy to deal with any emergency situation.

This emergency conversion kit is ideal for various applications such as emergency lighting, security systems, communication equipment and many other low W devices. With its informative tone, we want to highlight the importance of having a reliable and efficient solution in emergency situations.

Don't miss the opportunity to get the 20-50W Emergency Conversion Kit and make sure you have the necessary W to face any unforeseen situation. Don't compromise your safety and trust in the quality and efficiency of our product.

Don't wait any longer and get your kit now!



IP:
IP30
POWER SUPPLY:
170-265V AC
POWER MAX:
5 a 20
MATERIAL:
Termoplastico / PC
WORKING TEMP:
0°C + 50°C
BATTERY:
11.1V 3000 mAh
CHARGE TIME:
24 h
USE TIME:
180 min



REF	SIZE	COLOR
LM2128	215X40X27H mm	White



Kit de Conversion de Emergencia hasta 20W

El Kit de Conversión de Emergencia hasta 20W es una solución versátil y confiable para cualquier situación inesperada. Con una potencia máxima de 5 a 20 vatios, este kit se adapta a una amplia variedad de dispositivos eléctricos, proporcionando energía de respaldo en momentos críticos.

Una de las características destacadas de este kit es su protección **IP30**, lo que significa que está protegido contra el ingreso de cuerpos sólidos mayores a **2.5 mm** y no está protegido contra el ingreso de líquidos. Esto lo convierte en una opción ideal para su uso en interiores, ya sea en el hogar, la oficina o cualquier otro espacio.

La batería de **11.1V y 3000 mAh** es otro elemento esencial de este kit. Con una capacidad de carga de **3000 mAh**, esta batería puede alimentar dispositivos eléctricos durante un tiempo prolongado. Además, cuenta con una tecnología de carga rápida que le permite alcanzar su máxima carga en solo **24 horas**.

Con un tiempo de uso de hasta **180 minutos**, brinda suficiente energía para cubrir las necesidades básicas durante un apagón o cualquier otra emergencia. Ya sea que necesite cargar su teléfono móvil, usar una lámpara o incluso alimentar un pequeño electrodoméstico, este kit es capaz de satisfacer esas demandas.

La instalación del kit es simple y práctica. Viene con todas las herramientas necesarias y un manual de instrucciones detallado para que cualquier persona pueda realizar la instalación sin problemas. No se requieren conocimientos técnicos avanzados, lo que lo hace accesible.

The Emergency Conversion Kit up to 20W is a versatile and reliable solution for any unexpected situation. With a maximum power rating of 5 to 20 watts, this kit adapts to a wide variety of electrical devices, providing back-up power at critical times.

One of the outstanding features of this kit is its **IP30** protection, which means it is protected against the ingress of solid bodies larger than **2.5 mm** and is not protected against the ingress of liquids. This makes it an ideal choice for indoor use, whether in the home, office or any other space.

The **11.1V, 3000 mAh** battery is another essential element of this kit. With a charging capacity of **3000 mAh**, this battery can power electrical devices for an extended period of time. In addition, it features fast charging technology that allows it to reach its maximum charge in just **24 hours**.

With a usage time of up to **180 minutes**, it provides enough power to cover basic needs during a power outage or any other emergency. Whether you need to charge your mobile phone, use a lamp or even power a small appliance, this kit is capable of meeting those demands.

The installation of the kit is simple and practical. It comes with all the necessary tools and a detailed instruction manual so that anyone can perform the installation without any problems. No advanced technical knowledge is required, which makes it easy to install.

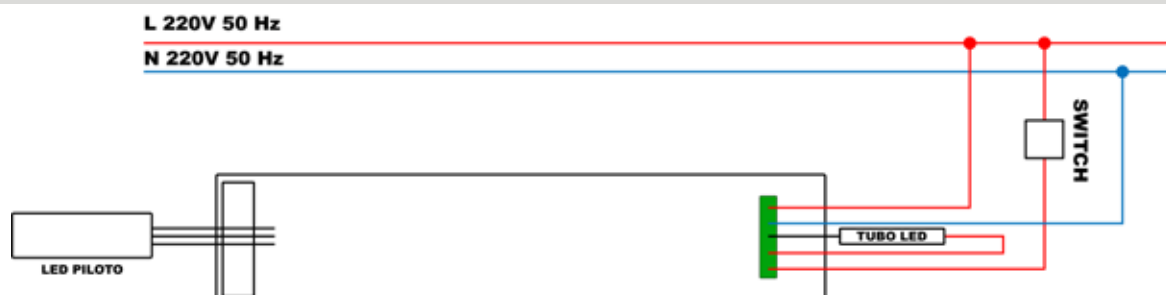

Emergency Conversion Kit up to 50W LF-GSP012YG



IP: IP20
POWER SUPPLY: 100-277V AC
OUTPUT: 25-48V DC
INTENSITY: 500 mA
MATERIAL: Metal
BATTERY: 14.4V 28.8WH
CHARGE TIME: 24 Hr
USE TIME: 90 min

REF	W	SIZE	COLOR
LF-GSP012YG	6	331X91X31H mm	Red



LF-GSP012YG

Diseñado y producido por Lifud Technology Co., Ltd., **LF-GSP012YG** es un controlador **LED** de emergencia que puede trabajar con un controlador **LED** externo (salida **DC 25-48V**, fuente de corriente constante de menos de 2A DC), juntos pueden alimentar la misma carga **LED** y satisfacer los requisitos de iluminación en situación normal y de emergencia. Cuando hay un fallo de alimentación, este driver de emergencia, **LF-GSP012YG**, cambia al modo de emergencia y proporciona al menos 1,5 horas de iluminación.

Este producto consta de una batería interna de níquel-cadmio, un circuito para la carga de la batería y un circuito para la conmutación de la tensión de emergencia. Aporta una mejor experiencia de usuario, ya que éste no necesita comprar e instalar el paquete de baterías. El rango de tensión de salida del **LF-GSP012YG** es de **25V-48V**, y la potencia de salida de emergencia es constante.

Evita eficazmente la reducción de la potencia de iluminación causada por la disminución de la tensión de la carga LED tras el uso prolongado del controlador de corriente constante LED.

Al mismo tiempo, para garantizar la seguridad, el controlador ha sido equipado con protección de cortocircuito de salida, protección de circuito abierto, protección de bajo voltaje y otras funciones.

Designed and Produced by Lifud Technology Co., LTD., **LF-GSP012YG** is a Uncomor Emergency **LED** that can work with external content (**25-48V DC 25-48V OUTPUT**, less than 2a DC Constant Current Source), together can align The misfortune of LED and satisfy is the normal situation in emergencies.

This product consists of an internal nickel-cadmium battery, a circuit for battery charging and a circuit for emergency voltage switching. batteries.**LF-GSP012YG 25V-48V**, constant emergency output power.

Effectively avoid the reduction of lighting power caused by the decrease of LED load voltage after prolonged use of LED constant current driver.

At the same time, to ensure the safety, control and control of been equipped and output short circuit protection, open circuit protection, low voltage protection and other functions.

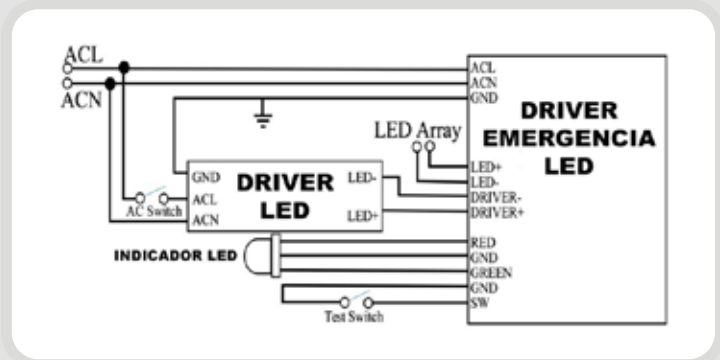
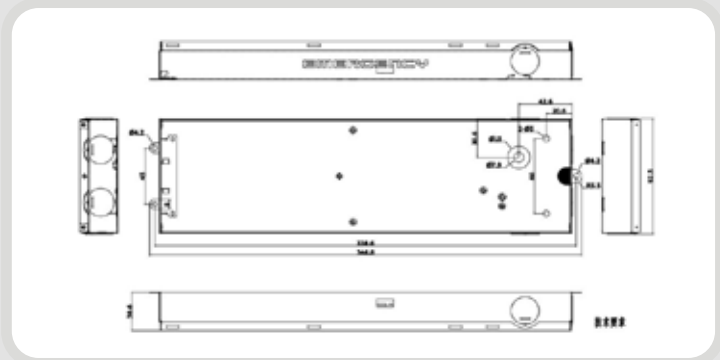



IP: IP67
 MATERIAL: PC
 INPUT CURRENT: ≤ 50 mA
 INPUT VOLTAGE: 11-13 Vc
 ATTENUATION OUTPUT: 0-10V
 OUTPUT CURRENT: 4 mA
 OUTPUT SOURCE CURRENT: 25 mA
 LUMINAIRE CONNECTION: 1 hasta 10



REF	SIZE	COLOR
LF-SCD010B	111X30 mm	Black

LF-SCD010B

Nuestro modelo **LF-SCD010B** es un conversor de señal aislado, que transforma la señal DALI / push en una salida de **0-10V**.

Se ajusta al protocolo **DALI IEC 62386-101, 102, 103, 207**. Su tensión de entrada oscila entre 11Vdc y 13Vdc. Un convertidor puede controlar hasta diez controladores LED de **0-10V** con una fuerte señal de salida de **0-10V**.

Se adapta con flexibilidad a muchos diseños de sistemas de iluminación **DALI** diferentes.

Our model **LF-SCD010B** is an isolated signal converter, which transforms the **DALI / push** signal into a **0-10V** output.

It conforms to the **DALI protocol IEC 62386-101, 102, 103, 207**. Its input voltage ranges from 11Vdc to 13Vdc. One converter can drive up to ten **0-10V LED** drivers with a strong **0-10V** output signal.

It flexibly adapts to many different **DALI** lighting system designs.

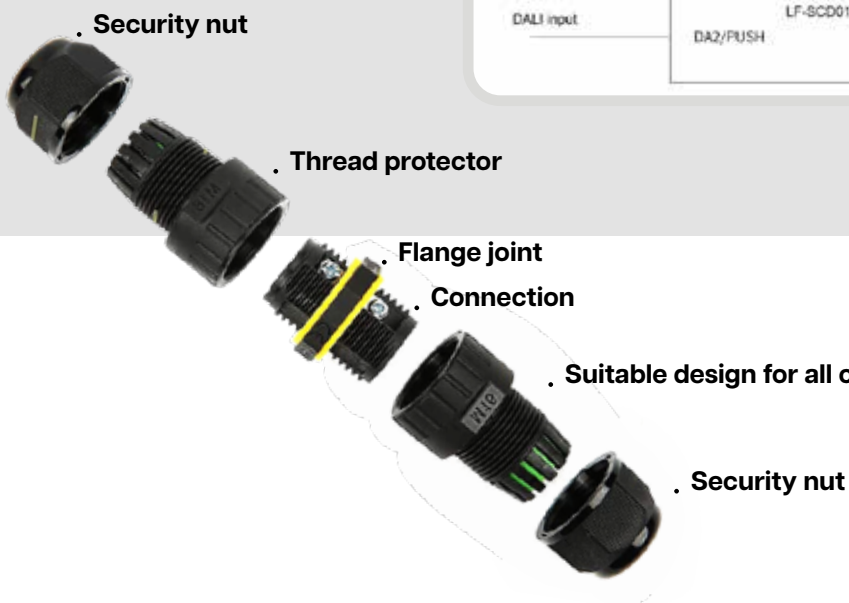
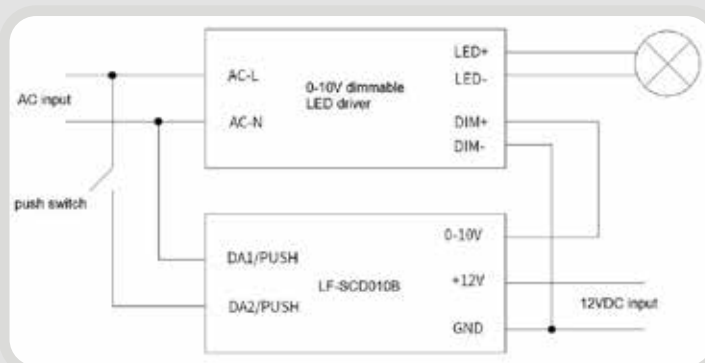

LED Surfled Flashlight with Hook and Magnet IP65 + Power Bank Function 6000K



IP:
IP65
POWER SUPPLY:
Batterys AAA no includes
BRIGHTNESS:
500
DURABILITY:
20000 Hr
MATERIAL:
ABS
LIGHT SOURCE:
Cob

REF	W	SIZE	COLOR
LM9041	5	68X35X110H mm	Black / Yellow



LED SurfLED Flashlight

Linterna de alta luminosidad, con un potente **LED COB de 5W**, ofreciendo **500 lumens**.

Recargable con cable USB (no incluido), **5 horas** de carga ofrecen **6 horas de autonomía**.

Batería (Power bank) **3.7V 4000 mAh** de muy larga duración que permite también cargar dispositivos USB (smartphones, tablets, etc) con cable mini USB (no incluido)

En la parte posterior incorpora un gancho y un potente imán.

High brightness torch, with a powerful **5W COB LED**, offering **500 lumens**.

Rechargeable with USB cable (not included), **5 hours** of charging offer **6 hours of autonomy**.

Very long-lasting **3.7V 4000 mAh** battery (Power bank) that can also charge USB devices (smartphones, tablets, etc.) with mini USB cable (not included).

On the back it has a hook and a powerful magnet.



Componentes Eléctricos - Electrical Components

www.ledme-europa.com

LED Dimmer 0-10V



IP:
IP20
POWER SUPPLY:
220-240V AC
POWER MAX:
250
MATERIAL:
PC
DIMMABLE:
0-10V
INSTALLATION:
Empotrable / Superficie

REF	SIZE	COLOR
LM9102	87X87X54 mm	White



Componentes Eléctricos - Electrical Components

www.ledme-europa.com

Flat Oxygen Electric Cable Hose 2X0.5mm² for Monocolor LED Strips - 500 meters



POWER MAX:
300V
INTENSITY:
5A
MATERIAL:
PC

REF	Sección de cable	SIZE	COLOR
LM2050	2X0.5 mm	500 m	Transparent
LM2053	4X0.25 mm	500 m	RGB
LM2054	2X0.5 mm	500 m	Red / Black



Componentes Eléctricos - Electrical Components

www.ledme-europa.com

Surge Protector 10kV SOSEN



IP:
IP20
POWER SUPPLY:
100-380V

REF	SIZE	COLOR
LM9029	75X35X28H mm	White



Componentes Eléctricos - Electrical Components

www.ledme-europa.com

Extractor Hadary 15W



IP:
IP44
POWER SUPPLY:
170-265V AC
NOISE:
30 dB
DURABILITY:
30000 Hr
MATERIAL:
PC
FLOW:
80 m3/hora

REF	W	SIZE	CUT	COLOR
LM9018	15	152X152X105H mm	98 mm	White



Included
Check valve

Componentes Eléctricos - Electrical Components

www.ledme-europa.com

Extractor Ofair 60X60 cm 50W



IP:
IP44
POWER SUPPLY:
170-265V AC
NOISE:
28 dB
DURABILITY:
30000 Hr
MATERIAL:
PC
FLOW:
650 m3/hora

REF	W	SIZE	CUT	COLOR
LM9019	50	595X595X140,5H mm	98 mm	White



Componentes Eléctricos - Electrical Components

www.ledme-europa.com

Extractor Hadary 14W



IP:
IP44
POWER SUPPLY:
170-265V AC
Ruido:
30 dB
MATERIAL:
PC

REF	W	dB	FLOW	SIZE	CUT	COLOR
LM9071	14	30 dB	78 m3/hr	158X162X100H mm	100 mm	White
LM9072	22	35 dB	138 m3/hr	208X213X100H mm	150 mm	White



Included
Check valve

Componentes Eléctricos - Electrical Components

www.ledme-europa.com

Quick connector with 3 inputs for up to 4 mm²



INTENSITY:
32A
MATERIAL:
PC

REF	COLOR
LM9055	Grey



Componentes Eléctricos - Electrical Components

www.ledme-europa.com

Clip-on terminal block with 3-pole quick connection



INTENSITY:
5A
MATERIAL:
PC

REF	COLOR
LM9020	White



BisaLight LED



IP:
IP20
POWER SUPPLY:
1 Pila modelo 23a
BRIGHTNESS:
200
ANGLE:
120°
MATERIAL:
ABS

REF	W	SIZE	COLOR
LM4234	0,5	70X40X20H mm	Grey



Included
Battery 23A

Feather Multifunction LED Flashlight with Magnet IP65



IP:
IP65
POWER SUPPLY:
Pilas AAA no incluidas
BRIGHTNESS:
160
DURABILITY:
20000 Hr
MATERIAL:
ABS
LIGHT SOURCE:
Cob

REF	W	SIZE	COLOR	°K
LM9042	4	23X160H mm	Black	6000K





String of 10 E27 Sockets Outdoor Ip65 Electric Cable

REF	SIZE	COLOR
LM8956	5000 mm	Black

3 YEARS
OF WARRANTY

SPECIFICATIONS

IP
IP65

POWER SUPPLY
170-265V AC

MATERIAL
PC

LED projector bracket



FINISH:
Black
MATERIAL:
Hierro

REF	SIZE
LM6653	360X150X83H mm
LM6654	530X155X75H mm
LM6656	720X155X75H mm



Componentes Eléctricos - Electrical Components

Wall Mount for LED Streetlights



FINISH:
Grey
MATERIAL:
Hierro
FASTENING DIAMETER:
45 mm

REF	SIZE
LM6657	500X150X73H mm



Componentes Eléctricos - Electrical Components

Articulated Arm for Streetlight 180°



FINISH:
Grey Antracite
MATERIAL:
Aluminium
FASTENING DIAMETER:
60 mm

REF	SIZE
LM6255	240X80X80 mm



